

User manual

Homira KNX 1-fold Mini Dimmer

HM-FM-01.DI

KNX/EIB Home and Building Control System

Attentions

1. Please keep devices away from strong magnetic field, high temperature, wet environment;



2. Do not fall the device to the ground or make them get hard impact;



3. Do not use wet cloth or volatile reagent to wipe the device;



4. Do not disassemble the devices.

 When using this product, please pay attention to analysis of the following troubleshooting.

NO.	Exception	Possible cause	Solution	Remark
1	Lamp flickers in the low brightness	Lamp driver works unstably at low voltage	Increase the min. brightness appropriately to debounce	
			Use the user defined curve, and set the output value when 1% as the min. brightness that can be stable	
2	There is no obvious differences for LED in the high brightness	The LED has reached the highest brightness after a certain voltage	Decrease the max. brightness appropriately to avoid the invalid control	
			Use the user defined curve, and set the output value when 100% as the control value of LED highest brightness	
3	Flicker or unstable when LED startup	Lamp driver needs an extra startup voltage for stable output	Enable the additional startup characteristic and set its parameter, to avoid the flicker when startup	
4	The min. control value when lamp off is higher than the value when lamp on	Lamp driver needs an extra startup voltage for lamp on normally	Enable the additional startup characteristic and set its parameter, to improved dimming effect	
5	Lamp flickers in dimming	Lamp dose not support dimming	Check the lamp characteristic supports dimming or not	If there is no improvement, it is suggested to replace the lamp or driver
		Incompatible between lamp and driver power supply	Check the lamp is matched to the driver or not	
		Incompatible of load type or dimming curve	Adjust the ETS parameter and check again	
		Brightness changed in dimming is too fast	Extend the dimming time and change the dimming curve	
		Incompatible of dimming curve if only flicker in a partial curve in the middle	Use the user defined curve to adjust the flickering curve	
		If only flicker in the high brightness	Decrease the max. brightness value	

NO.	Exception	Possible cause	Solution	Remark
5	Lamp flickers in dimming	Lamp driver is not good enough, unstable voltage, compatibility issue	Test with an additional incandescent lamp or electronic dummy load in parallel	If there is no improvement, it is suggested to replace the lamp or driver
6	The dimmable range is not 0-100%, not a good experience with user operation	It is the limitation of the operation voltage range and effect of lamp driver	Use the user defined curve, and set the output value when 1% as the min. brightness, set the output value when 100% as the control value of lamp highest brightness	
7	Lamp is still brighter at lower brightness, and have a small dimmable range	Incompatible of dimming curve	Change the curve to one with a lower change value, such as quadratic, cubic, exponential, logarithmic, even use the user defined curve	
		Possible the min. brightness is high	Check and decrease the min. brightness	
8	Switch off abnormally or can not turn on	Operation voltage failure	Check and reconnect	Configure the monitoring the group addresses of abnormal status objects, re-check to confirm there is an alarm telegram or not, if still exist alarm and improve again according the alarm telegram
		The connected lamp has been overloaded and caused the protection of over-temperature	Reduce the load power	
		Output terminal is short-circuit and trigger the protection	Reconnect the wiring and test that there are no problems before power up again	
		The inrush current of lamp driver is too big and trigger the protection of over-load	Reduce the load power	
			Change to trailing edge Change a better lamp or driver	
Bus voltage failure	Bus diagnostics and confirm to connect normally			
9	LED can not turn off	Incompatible between lamp driver and dimmer	Test with an additional incandescent lamp or electronic dummy load in parallel	If there is no improvement, it is suggested to replace the LED or driver
			Connect an external switch actuator channel with output in series, linking the switch object together to work simultaneously	
			Change a better LED or driver	

Contents

Chapter 1 Summary	1
Chapter 2 Technical Data	3
2.1. Load type	4
2.2. Operation mode	5
Chapter 3 Dimension and Connection Diagram	6
3.1. Dimension drawing	6
3.2. Connection Diagram	6
Chapter 4 Project Design and Programming	7
Chapter 5 Parameter setting description in the ETS	9
5.1. KNX Secure	9
5.2. Parameter window "General"	13
5.3. Parameter window "Output setting"	15
5.3.1. Parameter window "Channel"	16
5.3.2. Parameter window "User defined dimming curve"	25
5.3.3. Parameter window "Extension function"	27
5.4. Parameter window "UI setting"	41
5.4.1. Parameter window "Input x"	43
5.4.2. Parameter window "LED x"	59
5.5. Parameter window "Logic"	61
5.5.1. Parameter window "AND/OR/XOR"	62
5.5.2. Parameter window "Gate forwarding"	64
5.5.3. Parameter window "Threshold comparator"	66
5.5.4. Parameter window "Format convert"	68
5.5.5. Parameter window "Gate function"	69
5.5.6. Parameter window "Delay function"	71
5.5.7. Parameter window "Staircase lighting"	72
Chapter 6 Description of Communication Object	74
6.1. "General" Communication Object	74
6.2. "Output setting" Communication Object	75
6.3. "UI setting" Communication Object	79
6.3.1. "Input x" Communication Object	79
6.3.2. "LED x" Communication Object	83
6.4. "Logic" Communication Object	85
6.4.1. "AND/OR/XOR" Communication Object	85
6.4.2. "Gate forwarding" Communication Object	86
6.4.3. "Threshold comparator" Communication Object	87
6.4.4. "Format convert" Communication Object	87
6.4.5. "Gate function" Communication Object	90
6.4.6. "Delay function" Communication Object	91
6.4.7. "Staircase lighting" Communication Object	92

Chapter 1 Summary

Universal Dimming Actuator, Flush Mounted, 1-Fold (hereinafter referred to as Dimmer) has only 1 output channel, and it can connect with dimmable lamps (such as incandescent lamps, halogen lamps, energy-saving lamps, LED, etc.), and you can dim, preset scene, switch these lamps or other operations via the bus. In addition, the dimmer supports to dry contact input and LED output indication function, as well as KNX Data Secure.

This dimmer is compact and small in design, the output adopts screw terminal to realize electrical connection, and can be installed in a conventional 80 mm or 86mm wiring box. bus connection is directly connected via KNX terminal. The additional power supply is not required except KNX bus.

You can build the various scenes with the dimmer, such as watch movie, entertainment, dinner and rest, and so on; its brightness value can be set as any value (1-100%); it is able to set the duration time to dim up or down to the target brightness and the gradual speed to extend the luminaries life and save energy.

The physical address assignment and parameter settings can be used with the engineering tool software ETS (version ETS5 or above) with the .knxprod file.

In use you need to note **the type of connected electrical load, thus reasonable select them and note their technical performance. If the technical performance of the selected load is not consistent with the technical performance of the dimmer, it is possible to affect the dimming effect.**

The manual provides detailed technical information about the dimmer, including installation and programming details, and explains how to use the dimmer in conjunction with examples in actual use.

The functions are summarized as followed:

- Switch, Relative dimming/Absolute dimming
- Status feedback of switch, brightness, as well as abnormal status (short-circuit, over-voltage, over-temperature and operating voltage failure)
- Reset behaviour after download/bus recovery
- 6 dimming curves, including Linear, Exponential, Cubic, Quadratic, Logarithmic, Root and User defined curves
- Leading edge/Trailing edge phase cut dimming
- Staircase lighting, Flashing switch and Delay switch, as well as Scene, Threshold, Forced operation and Safety operation
- Dry contact input detection: support the functions of switch, dimming, sending value, scene, curtain, shift register, multiple operation and delay sending value
- Drive LED indicator: Connect type supports common-anode, and the voltage can be 5V or 12V
- Logic function, with AND, OR, XOR, Gate forwarding, Threshold comparator, Format convert, Gate function, Delay function and Staircase lighting
- Support the KNX Data Secure

Chapter 2 Technical Data

Power Supply	Bus voltage	21-30V DC, via the KNX bus
	Bus current	<18mA/24V, <16mA/30V
	Bus consumption	<480mW
Output	Dimming channel	1 fold
	Max. output capacity	200W (Incandescent/Halogen/LED, trailing edge)
	U _n rated voltage	230 V AC (50/60HZ)
	Protection	Short-circuit, Over-voltage, Over-temperature
	Standby loss	Approx. 0.5W
	Power loss	≤1.7W
Output LED	LED drive voltage	5V or 12V
	LED drive current	limited in 4mA
Connection	KNX	Bus connection terminals
	Outputs	Screw terminals, Wire Range 0.2-2.5mm ² , Torque 0.4N-m
	Input	≤10M
Operation and display	Programming button and Red LED	For assigning the physical address
	Green LED flashing	For displaying application layer running normally
Temperature	Operation	-5 °C ... + 45 °C
	Storage	-25 °C ... + 55 °C
	Transport	- 25 °C ... + 70 °C
Environment	Humidity	<93%, except dewing
Mounting	In a conventional 80mm or 86 mm wiring box	
Dimension	φ 53 × 23.5mm	
Weight	0.1KG	

2.1. Load type

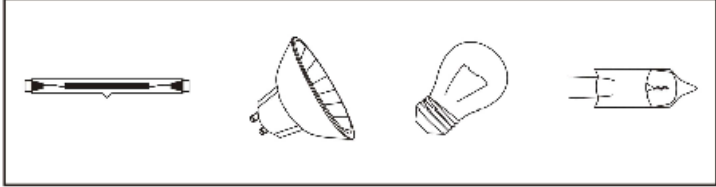
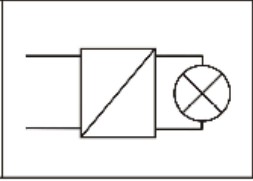
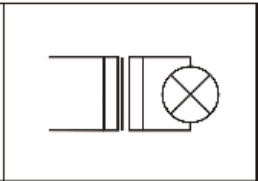
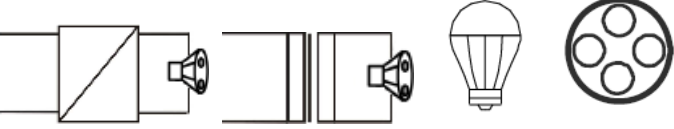
Load type	Max. Load capacity	
	Leading edge	Trailing edge
Incandescent lamp	10...200W	10...200W
HV Halogen lamp	10...200W	10...200W
LV Halogen lamp with Electronic transformer	10...200W	10...200W
HV LED	2...60W	2...200W
LV LED with Electronic transformer	2...60W	2...200W
LV LED with Constant current driver (Down light Spotlight)	2...60W	2...200W
LV LED with Constant voltage driver	2...60W	2...200W
Resistive load	R	
		
Capacitive load	C	
		
Inductive load	L	
		
LED load		

Note:

It is not permitted to connect inductive and capacitive loads together at the same output. However, mixing of loads such as capacitive + resistive loads or inductive + resistive loads is allowed to connect, but power reduction needs to be considered. It is more advisable to connect the same type of loads for

an output.

The max. load capacity depends on the surge current and power loss of the lamp, these types of lamp will cause large heating and high surge current in leading edge mode, especially LED lamp, so it is not recommended to drive LED in leading edge mode, make sure the connected lamp do not trigger over-load or over-heating protection.

2.2.Operation mode

Dimmer system is dimming in leading or trailing edge.

1.Dimming in leading edge:

Explanation of the dimming system: turn off dimmer in leading edge and turn on in trailing edge. As shown in the following figure, no voltage input from zero point until dimmer is turned on. It is suitable for inductive loads.

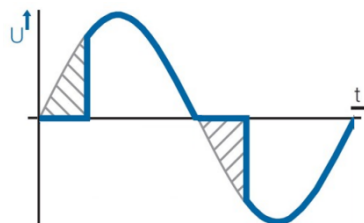

2.Dimming in trailing edge:

Explanation of the dimming system: turn on dimmer in leading edge and turn off in trailing edge. As shown in the following figure, dimmer will be turned on the zero-crossing point, during this moment, the voltage is very low and there is no inrush current to the load. In this way, there is no minimum load requirement, so that allows for better performance of a single lighting or a very small load and extends the life of the lamp, as well as reduce the interference to the power grid. It is suitable for resistive or capacitive loads.

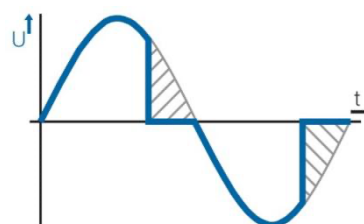

Chapter 3 Dimension and Connection Diagram

3.1. Dimension drawing

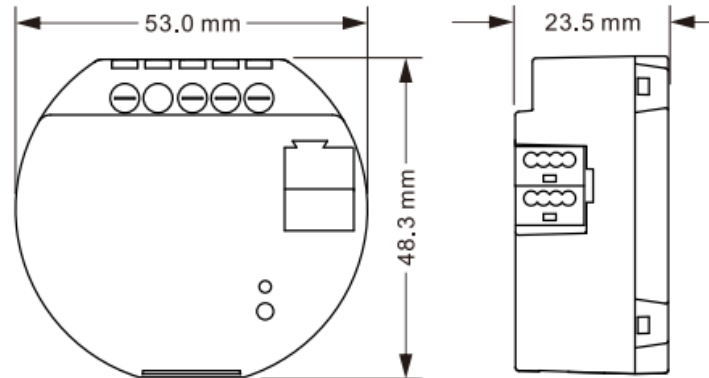

3.2. Connection Diagram

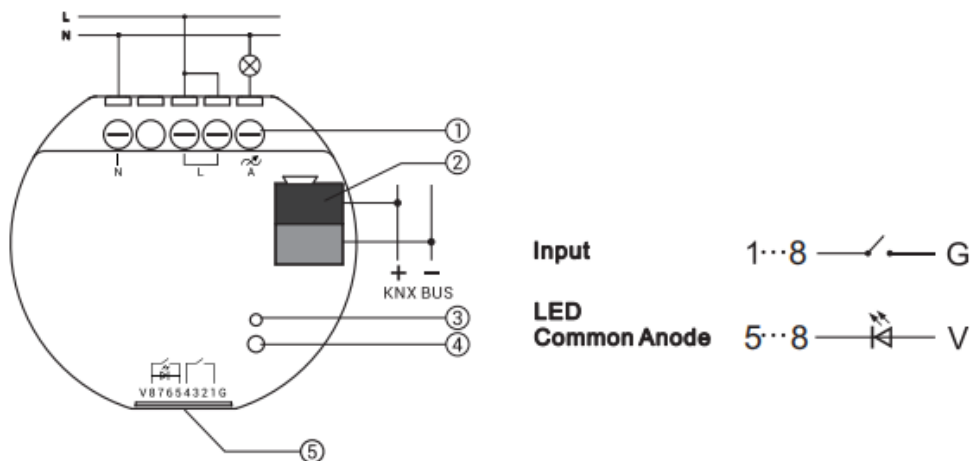

① Output terminals

② KNX bus terminal

③④ Programming button and LED

⑤ Input/Output LED

G: GND

V: VCC

1...8: Channel 1~8, note that channel 1-4 is only input while 5-8 can be configured as input or output

LED

Common Anode

Reset the device to the factory configuration: press the programming button and hold for 4 seconds then release, repeat the operation for 4 times, and the interval between each operation is less than 3 seconds

Chapter 4 Project Design and Programming

Application	Maximum of communication objects	Maximum number of group addresses	Maximum number of associations	Secure group addresses
KNX Universal Dimming Actuator, Flush Mounted,1-Fold/1.0	237	280	280	230

General function

General function includes device In operation setting and safety function.

Output channel

Only 1 channel, support to switch, relative dimming/absolute dimming, send the status of switch, brightness and the abnormal status (short-circuit, over-voltage, over-temperature and operating voltage failure), as well as reset behaviour after download/bus recovery.

Load types and dimming curves can be independently configured, as well as extension functions including Staircase lighting, Flashing switch, Delay switch, Scene, Threshold, Forced operation, Safety operation.

For output function, the definition of function priority: Forced > Safety > other functions, after exiting higher priority, the next priority action needs to be executed.

Input/LED output

Up to 8 channels, the first 4 channels only support to dry contact Input, and the last 4 channels can be selected as dry contact Input or LED output.

When dry contact Input, it can be connected to the dry contact panel or sensor, support the functions including switch, dimming, value output, scene control, Blind, shift register, multiple operation and delay mode (press/release, short/long, send after voltage recovery, disable function).

When LED output, only support to common anode, the drive voltage is 5V or 12V. Optionally, the LED output indication on the device can be controlled via an external object or is always on.

Logic function

Up to support 8 channels of logic, each channel up to support 8 inputs and 1 logic result.

Logic function support functions, including AND, OR, XOR, Gate forwarding, Threshold comparator, Format convert, Gate function, Delay function and Staircase lighting.

Chapter 5 Parameter setting description in the ETS

5.1.KNX Secure

Dimmer is a KNX device that complies with the KNX secure standard. That is, you can run the device in data secure mode.

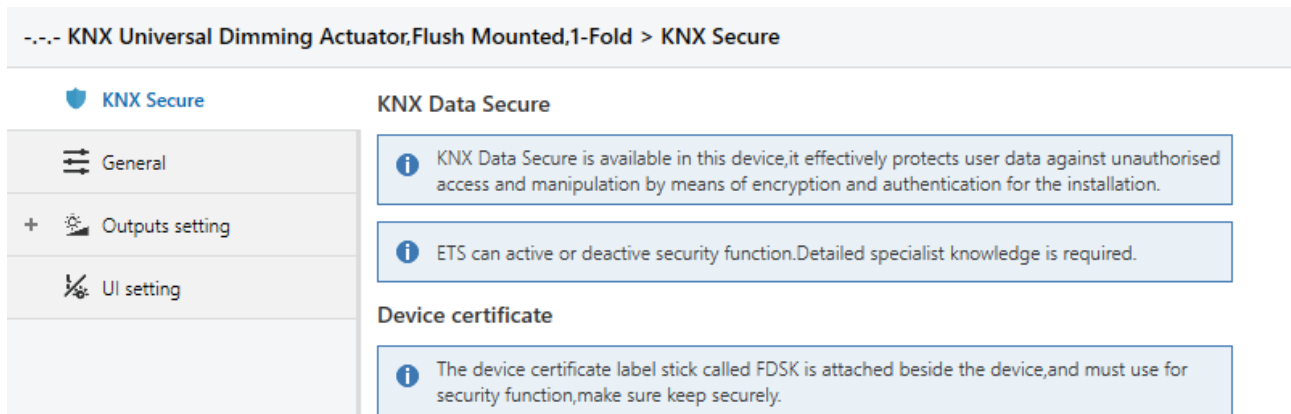

Fig.5.1 (1) "KNX Secure" parameter window

The device with KNX secure will be displayed notes on ETS, as shown as Fig.5.1(1).

If secure commissioning is activated in ETS project, the following information must be considered during device debugging:



❖ It is essential to assign a project password as soon as a KNX Secure device is imported into a project.

This will protect the project against unauthorized access.

The password must be kept in a safe place – access to the project is not possible without it (not even the KNX Association or device manufacturer will be able to access it)!

Without the project password, the commissioning key will not be able to be imported.

❖ A commissioning key is required when commissioning a KNX Secure device (first download). This key (FDSK = Factory Default Setup Key) is included on a sticker on the side of the device, and it must be imported into the ETS prior to the first download:

✧ On the first download of the device, a window pops up in the ETS to prompt the user to enter the key, as shown in Fig.5.1 (2) below.

The certificate can also be read from the device using a QR scanner (recommended).

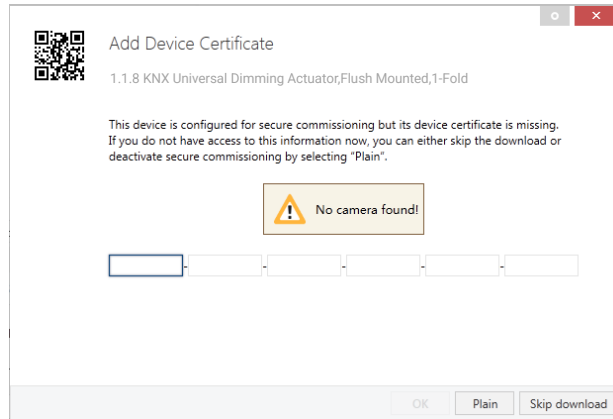

Fig.5.1(2) Add Device Certificate window

✧ Alternatively, the certificates of all Secure devices can be entered in the ETS beforehand.

This is done on the "Security" tab on the project overview page, as shown in Fig.5.1(3) below.

The certificates can be also added to the selected device in the project, as shown in Fig.5.1(4).

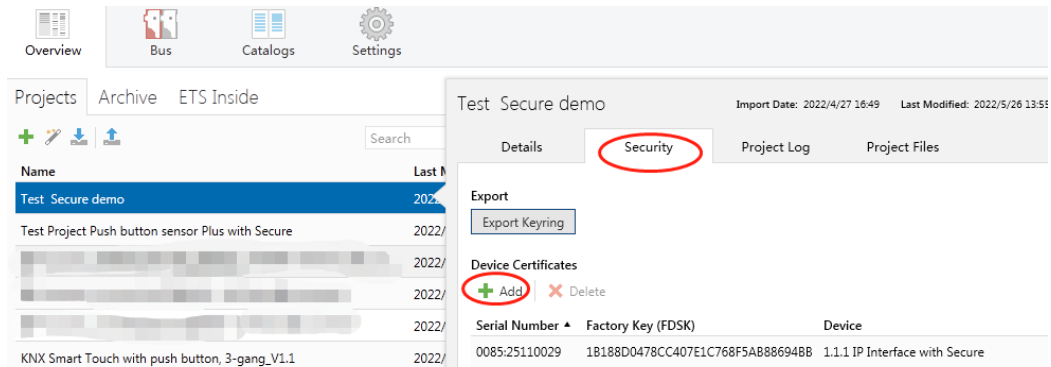

Fig.5.1(3) Add Device Certificate

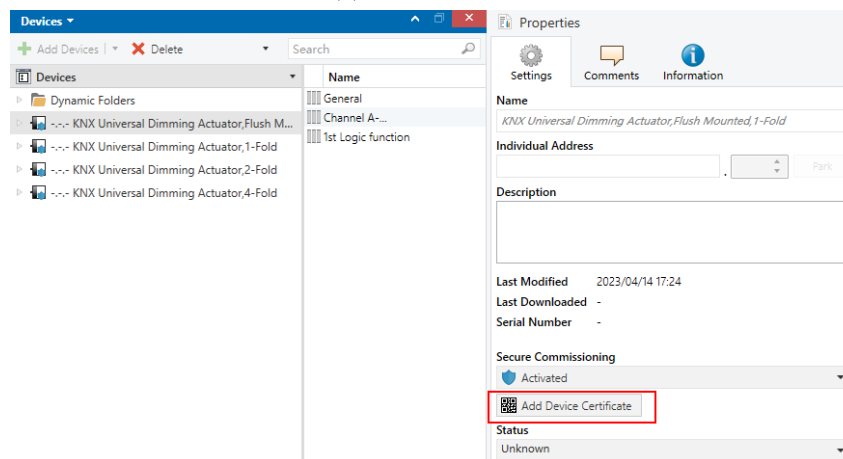

Fig.5.1(4) Add Device Certificate

✧ There is a FDSK sticker on the device, which is used for viewing FDSK number.

Without the FDSK, it will no longer be possible to operate the device in KNX Secure mode after a reset.

The FDSK is required only for initial commissioning. After entering the initial FDSK, the ETS will

assign a new key, as shown in Fig.5.1(5) below.

The FDSK will be required again only if the device was reset to its factory settings (e.g. If the device is to be used in a different ETS project).

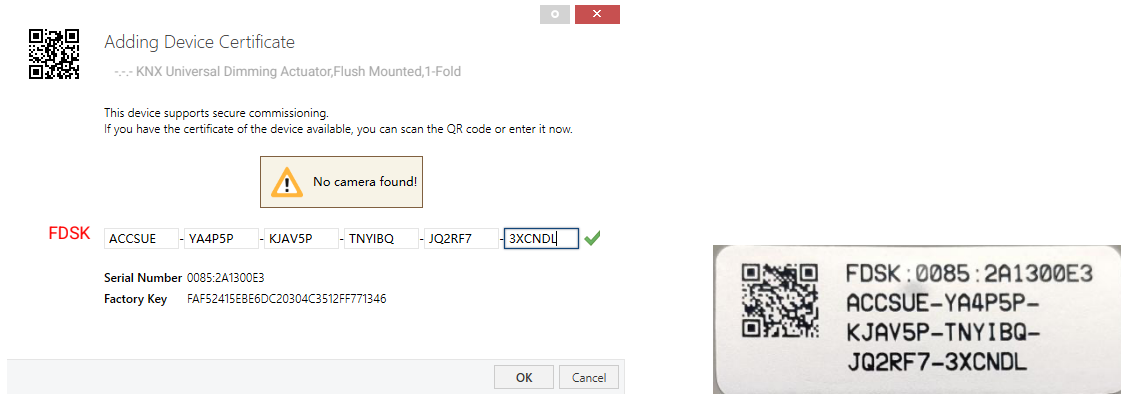

Fig.5.1(5)

Example:

If this application in the project needs to be tried with another device, it is no longer the original device. When the application is downloaded to a new device, the following prompt will appear on the left of Fig.5.1(6), click yes, the Add Device Certificate window will appear, then enter the initial FDSK of the new device, and you need to reset the device to the factory settings (it is not required if the device is still factory default; If it has been used, it will be required to reset, otherwise the following error message will appear on the right of Fig.5.1(6)), and then the device can be successfully downloaded again.

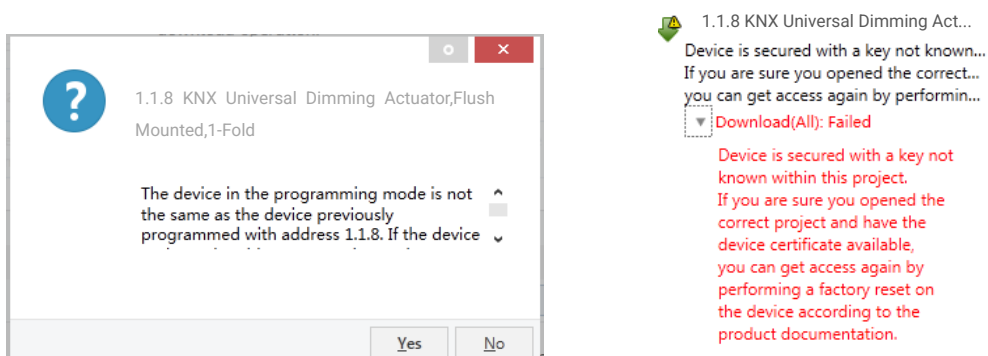

Fig.5.1(6) Example

Whether the device is replaced in the same project, or the device is replaced in a different project, the processing is similar: **Reset the device to the factory settings, then reassign the FDSK.**

After the device is downloaded successfully, the label Add Device Certificate turns gray, indicating

that the key for this device has been assigned successfully, as shown in Fig.5.1(7) below.

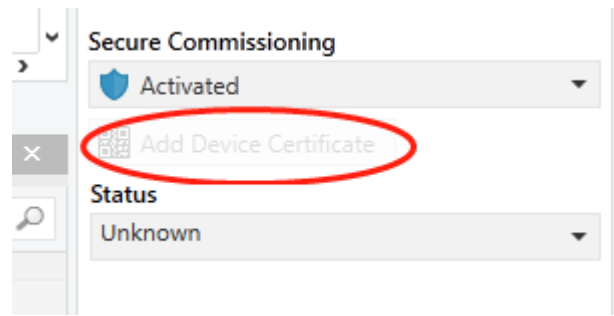

Fig.5.1(7)

ETS generates and manages keys:

Keys and passwords can be exported as needed to the use of security keys outside of the associated ETS projects. As shown in Fig.5.1(8) below, the file extension is .knxkeys.

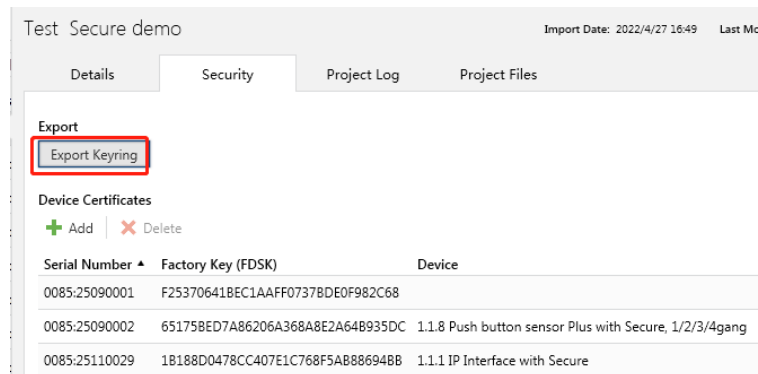

Fig.5.1(8)

Note: Any USB interface used for programming a KNX Secure device must support "long frames".

Otherwise ETS will report a download failure information, as shown below.

5.2. Parameter window "General"

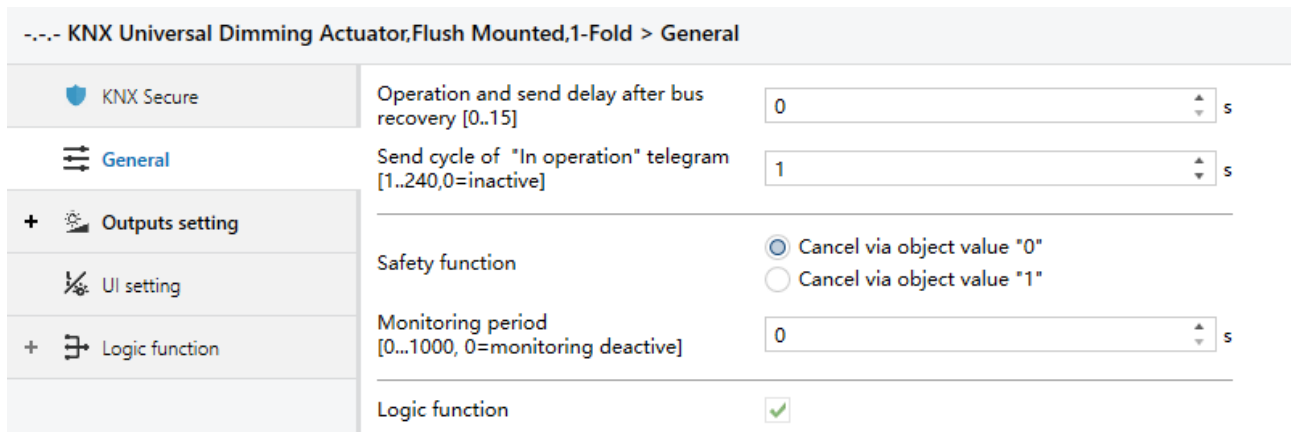

Fig.5.2 "General setting" parameter window

Parameter "Operation and Send delay after bus recovery [0..15]"

This parameter is for setting the delay time to send to bus after the device bus recovery.

Options: **0..15 s**

The setting dose not contain the device initialization time, and bus telegrams received during delay time will be recorded.

Parameter "Send cycle of "In operation" telegram [1..240,0=inactive]"

This parameter is for setting the time interval when cyclically send telegrams through the bus to indicate this device in normal operation. When set to "0", the object "In operation" will not send a telegram. If the setting is not "0", the object "In operation" will send a telegram according to the setting period time with logic "1" to the bus. Options: **0...240 s, 0= inactive**

As to reduce the bus load as much as possible, the maximum time interval should be selected according to actual application requirement.

Parameter "Safety function"

This parameter is for setting the object value of safety status cancellation for whole device, while receiving the reversed value is to enter safety status. Options:

Cancel via object value "0"

Cancel via object value "1"

When enter safety status, execute the configured behaviour of the channel if its safety function is enabled, more details are defined in the channel.

Parameter "Monitoring period [0...1000, 0=monitoring deactive]"

This parameter is for setting the period to monitor the telegram of safety object.

Options: **0...1000 s**

If the period is greater than 0, the telegram to cancel safety status was not received during the monitoring period, enter the safety status. Exit this status and reset the monitoring period when a cancellation telegram is received. It is also possible to enter the safety status directly by receiving the reversed value defined by the previous parameter.

If the period is set as 0, enter the safety status directly by receiving the reversed value defined by the previous parameter, and receiving cancellation value is to exit the status.

Parameter "Logic function"

Setting page of logic function interface is visible after this parameter enabled.

5.3. Parameter window "Output setting"

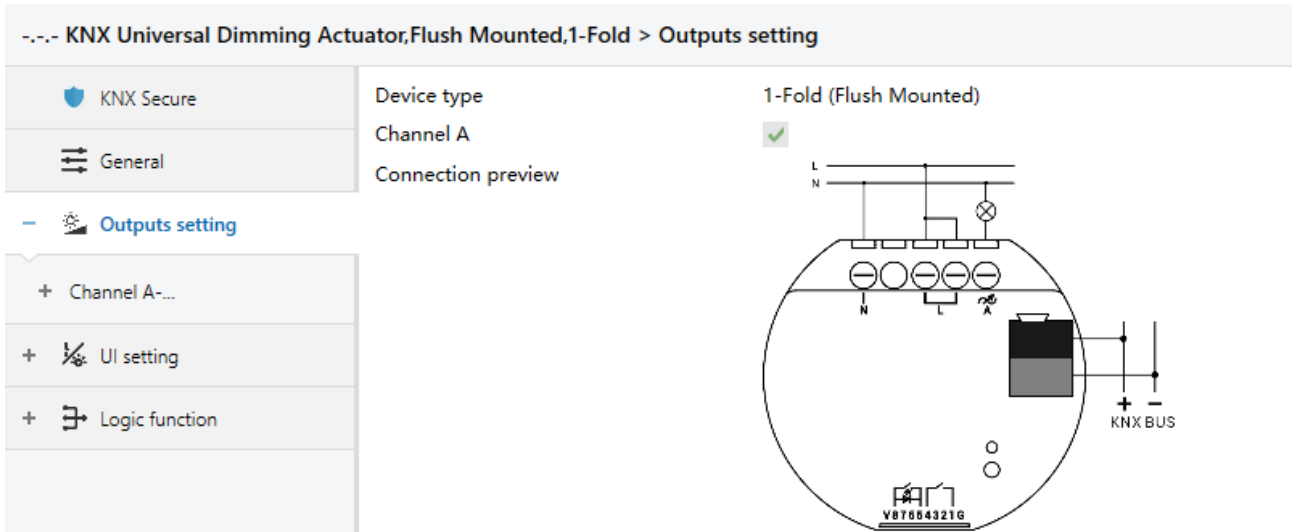

Fig.5.3 "Output setting" parameter window

Parameter "Device type"

This parameter is for displaying the device type, it is according to the product: **1-Fold (Flush Mounted)**

Display corresponding connection preview below the parameter.

Parameter "Channel A"

This parameter is for setting whether to enable dimming channel, corresponding parameter window is visible when enabled. The parameter is enabled by default on the ETS and cannot be set.

5.3.1. Parameter window "Channel"

--- KNX Universal Dimming Actuator, Flush Mounted, 1-Fold > Outputs setting > Channel A---

KNX Secure	Description (max 30char.)	<input type="text"/>
General	Load type	LED (trailing edge) ▼
Outputs setting	Dimming curve	User defined ▼
Channel A---	General dimming time (from min. to max.)	4 s ▲▼
User defined dimming cur...	Minimum brightness value	1 % ▲▼
Scene function	Maximum brightness value	100 % ▲▼
Time function	Switching on value	<input type="radio"/> Preset brightness value <input checked="" type="radio"/> Last brightness value
Threshold function	Dimming mode selection for switching on	<input type="radio"/> Jumping <input checked="" type="radio"/> Dimming
Forced function	Dimming mode selection for switching off	<input checked="" type="radio"/> Jumping <input type="radio"/> Dimming
Safety function	Dimming time for relative dimming	4 s ▲▼
UI setting	Dimming time for absolute dimming	4 s ▲▼
Logic function	Allow switch off via relative dimming	<input checked="" type="checkbox"/>
	Absolute dimming value lower than the minimum value	0%=0%, otherwise=Minimum brightness value ▼
	Additional startup characteristic when the lamp is off	<input checked="" type="checkbox"/>
	Startup brightness value	50 % ▲▼
	Behavior for dimming up	Dim up based on the startup brightness ▼
	Behavior when the switch or dimming value is lower than startup value	Jump to startup brightness ▼
	Reset behavior	
	Behavior after download	Switching off ▼
	Behavior after bus failure	Switching off
	Behavior after bus recovery	Brightness before bus failure ▼
	Short-circuit detect for operating supply or device reset if output is off	<input checked="" type="checkbox"/>
<p> Note: the short-circuit detect may occur a briefly flashing for some lamps</p>		

Fig.5.3.1(1) "Channel" parameter window

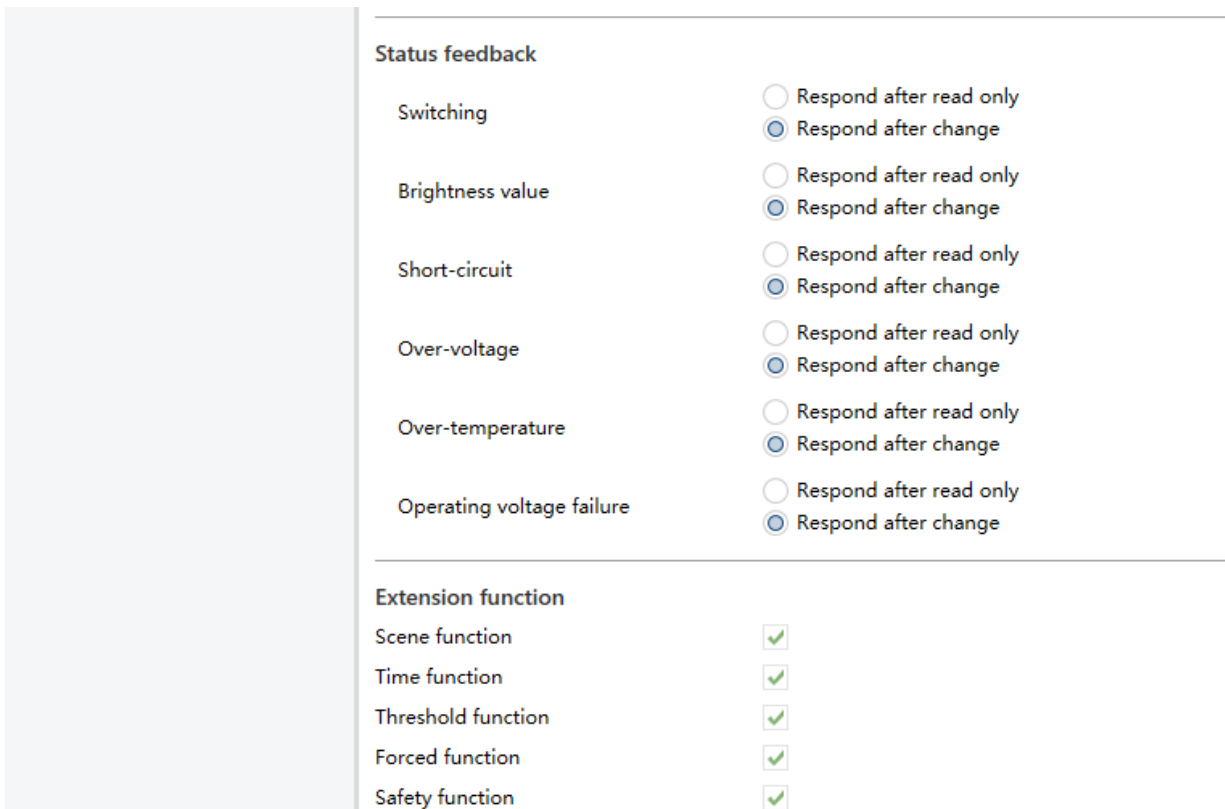

Fig.5.3.1(2) "Channel" parameter window

Parameter "Description (max 30char.)"

This parameter is for setting the name description of the channel.

Parameter "Load type"

This parameter is for setting the load type of the channel. Options:

Resistive&Capacitive load (trailing edge)

Inductive load (leading edge)

LED (trailing edge)

LED (leading edge)

Parameter "Dimming curve"

This parameter is for setting dimming cure of the channel, display corresponding preview figure below the parameter. Options:

Logarithmic function

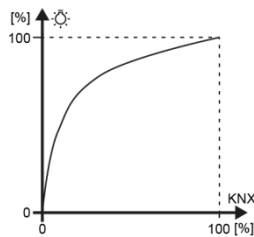

Cubic function

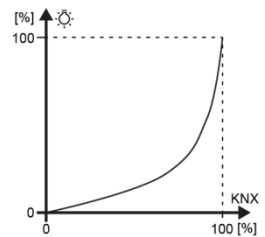

Root function

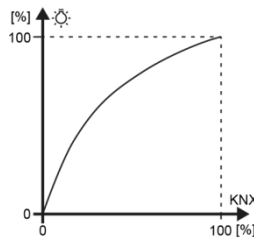

Exponential function

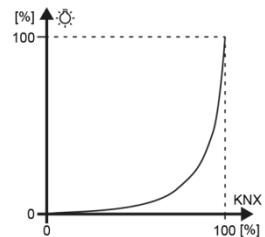

Linear function

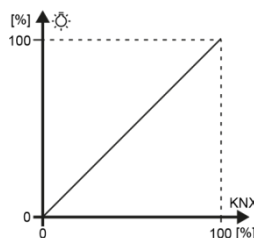

User defined

Quadratic function

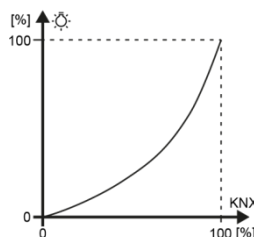

When "User defined" is selected, user can custom a dimming curve, more detail please refer to chapter 5.3.2.

Parameter "General dimming time (from min. to max.)"

This parameter is for setting the time for the whole dimming process, which refers to the time from minimum to maximum value. Suppose the time is set as 6s, the min. Value is 0% and the max. is 100%, if the brightness is only dimmed from 0% to 50%, then the dimming time only takes 3s.

Options: **2...255 s**

If the channel function has not specified a dimming time, use the time set by this parameter, functions such as switch on/off lamps, forced, safety, staircase lighting, threshold, etc.

Parameter "Minimum brightness value"

Parameter "Maximum brightness value"

These parameters are for setting minimum and maximum brightness values individually, to limit the output range of dimming brightness, which is allow the lamps work in a better brightness range depending on the environment or lamps compatibility.

This range is not allowed to be exceeded in any status of lamps on, including threshold, forced, safety functions, etc. Output as min. value when the brightness is lower than the min., and output as max. value when it is higher than the max.

Options of the min. value: **1...49 %**; Options of the max. value: **50...100 %**

Parameter "Switching on value"

This parameter is for setting the brightness when the lamp is switched on. Options:

Preset brightness value

Last brightness value

Last brightness value: When the device is powered on for the first time or restarted after downloading, the default value for " Switch ON" is 50%, meaning the brightness value is 50%.

Parameter "Preset brightness value"

This parameter is visible when previous parameter is selected "Preset brightness value". Set the preset brightness value. Options: **1...100 %**

Parameter "Dimming mode selection for switching on"

This parameter is for setting the dimming mode when the lamp is switched on. Options:

Jumping

Dimming

Jumping: switch on immediately and directly to the target brightness.

Dimming: switch on with dimming to the target brightness and use the General dimming time.

Parameter "Dimming mode selection for switching off"

This parameter is for setting the dimming mode when the lamp is switched off. Options:

Jumping

Dimming

Jumping: switch off immediately.

Dimming: switch off with dimming and use the General dimming time.

Parameter "Dimming time for relative dimming"

This parameter is for setting the time for the whole relative dimming process. Options: **2...255 s**

Parameter "Dimming time for absolute dimming"

This parameter is for setting the time for the whole absolute dimming process. Options: **2...255 s**

Parameter "Allow switch off via relative dimming"

This parameter is for setting whether allow to switch lamp off via relative dimming. When disabled, it can only be adjusted downward to the minimum brightness value; while enabled, switch the lamp off directly when the brightness is dimming to less than the minimum brightness value.

Parameter "Absolute dimming value lower than the minimum value"

This parameter is for setting the behaviour when absolute dimming value lower than the minimum value, **it only affects the object "Absolute dimming"**. Options:

0%=0%, otherwise=Minimum brightness value

To be the minimum brightness value

To be 0%

0%=0%, otherwise=Minimum brightness value%: output as min. value when the value is lower than the min., but the value is 0% is to switch the lamp off.

To be the minimum brightness value: output as min. value when the value is lower than the min., even if the value is 0%.

To be 0%: switch the lamp off directly when the value is lower than the min.

Parameter "Additional startup characteristic when the lamp is off"

This parameter is for setting whether the lamp needs the startup characteristic additionally when the lamp is off. Some lamps require a higher voltage to start up when switched off.

Following four parameters are visible when parameter is enabled.

Parameter "Startup brightness value"

This parameter is for setting the brightness value of lamp startup. Options: **5..90 %**

Note: the brightness must not exceed the max. and min. value, otherwise it cannot be set in the ETS.

Parameter "Behavior for dimming up"

This parameter is for setting the behavior for dimming up when the lamp is off. Options:

Ignore the telegram

Like normal

Dim up based on the startup brightness

Ignore the telegram: send an off telegram immediately to synchronize the status with the control device.

Like normal: dimming up and output normally.

Dim up based on the startup brightness: use the startup brightness as a based point, and dimming up from this brightness.

Parameter "Behavior when the switch or dimming value is lower than startup value"

This parameter is for setting the behavior when the target brightness is lower than startup value, and the lamp is off. Options:

Ignore the telegram

Like normal

Jump to startup brightness

Jump to startup then delay to target

Ignore the telegram: send a off telegram immediately to synchronize the status with the control device.

Like normal: dimming and output normally.

Jump to startup brightness: jump to the startup brightness immediately and send the new brightness to the bus.

Jump to startup then delay to target: jump to startup brightness firstly then dimming to the target brightness after the delay has elapsed.

If the target brightness is higher than startup value, dimming from the startup value to the target brightness directly, it is only applied to receive the telegrams of objects "Switching" and "Absolute dimming".

Parameter "Delay time after reach startup"

This parameter is visible when previous parameter is selected "Jump to startup then delay to target".

Set the delay time for dimming to target brightness after reaching the startup value. Options:

50ms

80ms

100ms

...

2s

4s

5s

Reset behavior

Parameter "Behavior after download"

This parameter is for setting the behaviour of channel after download. Options:

Switching off

Preset brightness value

Brightness before bus failure

Preset brightness value: dimming to a setting brightness, defined by next parameter.

Brightness before bus failure: recover to the brightness value stored when the bus failure.

Parameter "Preset brightness value"

This parameter is visible when "Preset brightness value" is selected. Set the preset brightness value.

Options: **1...100 %**

Parameter "Behavior after bus failure"

This parameter is for setting the behaviour of channel after bus failure.

The dimmer (ADUDF-01/01.1) does not support handling the brightness after bus failure, it is switched off directly, so the option is only Switching off

Parameter "Behavior after bus recovery"

This parameter is for setting the behaviour of channel after bus recovery.

Switching off

Preset brightness value

Brightness before bus failure

Preset brightness value: dimming to a setting brightness, defined by next parameter.

Brightness before bus failure: recover to the brightness value stored when the bus failure.

Parameter "Preset brightness value"

This parameter is visible when "Preset brightness value" is selected. Set the preset brightness value.

Options: **1...100 %**

Parameter "Short-circuit detect for operating supply or device reset if output is off"

This parameter is for setting whether detect short-circuit for operating supply or device reset if output is off.

When disabled, a short-circuit may be detected only when turn on the lamp until exceed the threshold of short-circuit detection.

When enabled, every time a operating supply or device voltage recovery, it needs to detect a short-circuit firstly if initially the lamp is off or the brightness is lower than the threshold of short-circuit detection, but it is not required to detect if the brightness is higher than the threshold of short-circuit detection. Download database and restart, if the detection has been normal before the download, there is no need to repeat the detection, otherwise it is still necessary to perform a detection.

 Note: the short-circuit detect may occur a briefly flashing for some lamps

Status feedback

Parameter "Switching/Brightness value/Short-circuit/Over-voltage/Over-temperature/Operating voltage failure"

These parameters are for setting the way to send the status of switch, brightness and abnormal status. The abnormal status including short-circuit, over-voltage, over-temperature, operating voltage failure. Options:

Respond after read only

Respond after change

Handling of abnormal status:

Trigger hardware protection when channel load terminal is short-circuited, and send the status to bus. It will disconnect the output when in protection. If it is the first time a short-circuit has been detected since power on, disconnect the output first then wait a 1 minute to output the current control value again;

but if there is still a short-circuit, disconnect the output permanently, and cannot be used unless the device is restarted.

Trigger hardware protection when the operated voltage is higher than the rated voltage, and send the status to bus. It will disconnect the output when in protection.

When the measured internal temperature exceeds 80°C for 10s, then will trigger over-temperature protection and send the status to bus. The brightness will down to 20% or to the minimum value under the protection status. After the temperature is reduced to below 70°C, output normally if a new control telegram is received.

Operation voltage is failure when no valid over-zero signal is detected, and send the status to bus. When in voltage failure, it can not send control status and no drive signal if receive the control telegram, need to power supply normally and has actual output value can send the current status of the lamp.

Extension function

Parameter "Scene function"

Setting page of scene function interface is visible after this parameter enabled.

Parameter "Time function"

Setting page of time function interface is visible after this parameter enabled.

Parameter "Threshold function"

Setting page of threshold function interface is visible after this parameter enabled.

Parameter "Forced function"

Setting page of forced function interface is visible after this parameter enabled.

Parameter "Safety function"

Setting page of safety function interface is visible after this parameter enabled.

5.3.2.Parameter window "User defined dimming curve"

--- KNX Universal Dimming Actuator,Flush Mounted,1-Fold > Outputs setting > Channel A-... > User defined dimming curve

<ul style="list-style-type: none"> KNX Secure General Outputs setting Channel A-... <ul style="list-style-type: none"> User defined dimming c... Scene function Time function Threshold function Forced function Safety function UI setting Logic function 	<p>Number of curve coordinate points <input type="text" value="4"/></p> <hr/> <p>Coordinate point 1</p> <p>KNX dimming value <input type="text" value="1"/> %</p> <p>Output value <input type="text" value="1"/> %</p> <hr/> <p>Coordinate point 2</p> <p>KNX dimming value <input type="text" value="10"/> %</p> <p>Output value <input type="text" value="10"/> %</p> <hr/> <p>Coordinate point 3</p> <p>KNX dimming value <input type="text" value="20"/> %</p> <p>Output value <input type="text" value="20"/> %</p> <hr/> <p>Coordinate point 4</p> <p>KNX dimming value <input type="text" value="100"/> %</p> <p>Output value <input type="text" value="100"/> %</p>
--	---

Fig.5.3.2 "User defined dimming curve" parameter window

Parameter "Number of curve coordinate points"

This parameter is for setting the number of curve coordinate points. Options: **2...16**

Coordinate point x (x=1~16)

Parameter "KNX dimming value"

This parameter is for setting KNX dimming value of the curve. Options: **1..100%**

For user defined dimming curve, the first and the last one points are fixed to 1% and 100%.

Note: the previous KNX dimming value must be small than next one, otherwise it can not be set on the ETS:

Coordinate point 2

KNX dimming value %

Output value %

Coordinate point 3

KNX dimming value %

Output value %

Parameter "Output value"

This parameter is for setting the output value corresponding to the KNX dimming value.

Options: 1..100%

Note: the previous output value must be small than next one, otherwise it can not be set on the ETS:

Coordinate point 2

KNX dimming value %

Output value %

Coordinate point 3

KNX dimming value %

Output value %

Custom curves with different number of coordinate points, as shown as following:

Example 1

(3 coordinate points)

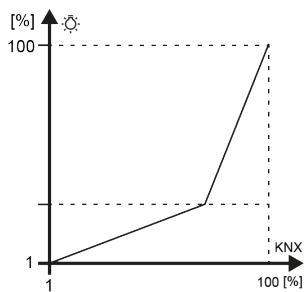

Example 2

(4 coordinate points)

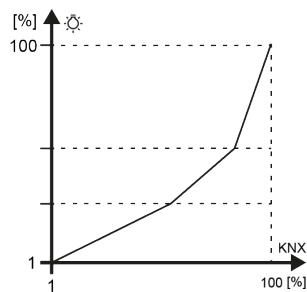

Example 3

(5 coordinate points)

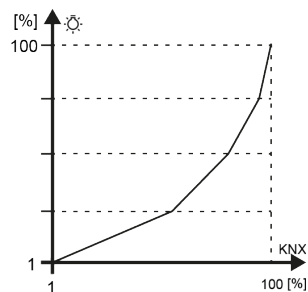

Example 4

(6 coordinate points)

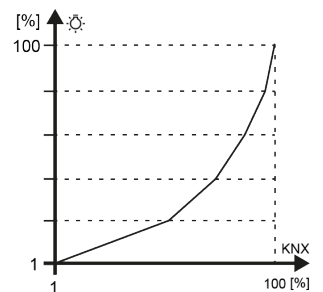

Commissioning steps of User defined dimming curve:

Step 1: use the linear function curve at first to determine the adjustable range, then obtain the minimum and maximum adjustable brightness values of the applied lamp with absolute dimming;

Step 2: when testing in step 1, you can experience the brightness changes with relative dimming, then checking the number of curve areas and coordinate points;

Step 3: the minimum brightness value is the point of knx value 1%, the maximum brightness value is the point of knx value 100%;

Step 4: add the coordinate points of the middle section according to the planning area;

Step 5: download and commission, according to the experience of dimming process, there may also be slight adjustment of the coordinate points or increase the configuration areas, and even need to adjust the dimming time, until achieve the best results for user satisfaction.

5.3.3.Parameter window "Extension function"

Parameter windows are visible according to the enabling of the extension function parameters.

5.3.3.1. Parameter window "Scene function"

--- KNX Universal Dimming Actuator, Flush Mounted, 1-Fold > Outputs setting > Channel A-... > Scene function

KNX Secure

General

Outputs setting

Channel A-...

User defined dimming cur...

Scene function

Time function

Threshold function

Forced function

Safety function

UI setting

Logic function

Overwrite scene stored values during download

Scenes	Description	Scene NO.	Brightness	Dimming
Scene 1		1	50 %	4 s
Scene 2		2	50 %	4 s
Scene 3		3	50 %	4 s
Scene 4		7	50 %	4 s
Scene 5		8	50 %	4 s
Scene 6		0	NA	NA
Scene 7		0	NA	NA
Scene 8		0	NA	NA
Scene 9		0	NA	NA
Scene 10		0	NA	NA
Scene 11		0	NA	NA
Scene 12		0	NA	NA
Scene 13		0	NA	NA
Scene 14		0	NA	NA
Scene 15		0	NA	NA
Scene 16		0	NA	NA

Fig.5.3.3.1 "Scene function" parameter window

Scene function can work with the control panel or other software to execute the setting scene and output the specified brightness.

Parameter "Overwrite scene stored values during download"

This parameter is for setting whether to override the scene stored values during application download. If select to overwrite, follow the parameter setting, otherwise for the brightness value corresponding to the scene number that has saved the modified value has executed, the last saved value will remain; for the modified brightness has not executed, still use the value set by parameter.

Scene x (x=1~16)

Parameter "Description"

This parameter is for setting the name description of the corresponding scene, up to 30 characters.

Parameter "Scene NO."

This parameter is for setting the triggered scene number, up to 16 scenes. Options: **0...64**

When scene number is 0, it is invalid, and the brightness and dimming time cannot be set, as shown as following:

Scenes	Description	Scene NO.	Brightness	Dimming
Scene 1		0	NA	NA

When scene numbers are greater than 0, if there are same scene numbers, display following error message:

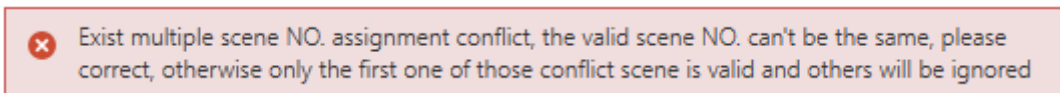

Parameter "Brightness"

This parameter is for setting the brightness of the corresponding scene. Options: **0...100 %**

Parameter "Dimming"

This parameter is for setting the dimming time of the corresponding scene. Options: **2...255 s**

5.3.3.2.Parameter window "Time function"

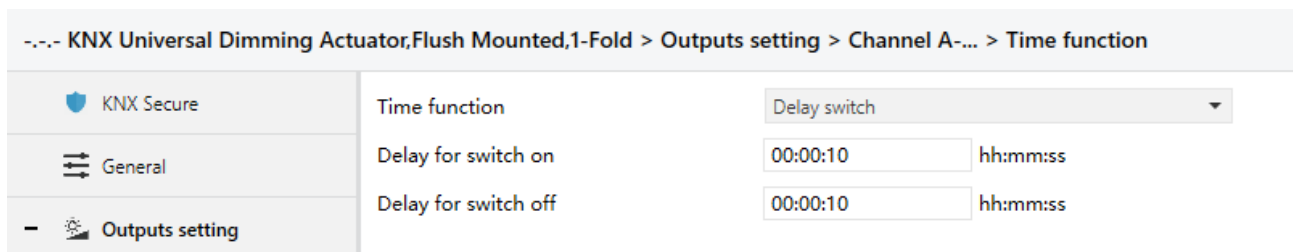

Delay switch

--- KNX Universal Dimming Actuator,Flush Mounted,1-Fold > Outputs setting > Channel A-... > Time function

<ul style="list-style-type: none"> KNX Secure General Outputs setting <ul style="list-style-type: none"> Channel A-... <ul style="list-style-type: none"> User defined dimming cur... Scene function 	<p>Time function: Flashing switch</p> <p>On time for flashing: 00:00:10 hh:mm:ss</p> <p>Off time for flashing: 00:00:10 hh:mm:ss</p> <p>Number of flashing cycles [0..10000,0=no limit]: 0</p> <p>Status after flashing: Unchange</p> <p>Control mode of flashing: Start with "1", Stop with "0"</p>
--	--

Flash switch

--- KNX Universal Dimming Actuator,Flush Mounted,1-Fold > Outputs setting > Channel A-... > Time function

<ul style="list-style-type: none"> KNX Secure General Outputs setting <ul style="list-style-type: none"> Channel A-... <ul style="list-style-type: none"> User defined dimming cur... Scene function Time function Threshold function Forced function 	<p>Time function: Staircase lighting</p> <p>Duration time: 00:02:00 hh:mm:ss</p> <p>Time extension: Retriggerable</p> <p>Control mode of staircase lighting: Start with "1", Off with "0"</p> <p>Prewarning before staircase time end: Dim-down the dimming value and via object</p> <p>Warning time: 00:00:30 hh:mm:ss</p> <p>Value of dimming down: 20 %</p> <p>Duration time can be changed via bus: <input checked="" type="checkbox"/></p> <p>i The duration time receiving from bus must be longer than the warning time,otherwise it will be ignored</p>
---	--

Staircase lighting

Fig.5.3.3.2 "Time function" parameter window

Different configurations of time function can be used for different application.

Parameter "Time function"

This parameter is for setting the time function, its brightness is depending on the value of switch on/off. Options:

Delay switch

Flashing switch

Staircase lighting

Delay switch: delay a period time to switch on/off, dimming mode is Jumping.

Flashing switch: flashing to switch on/off, dimming mode is Jumping.

Staircase lighting: dimming mode is Jumping, use the General dimming time.

Note: time function will be interrupted directly after entering safety or forced operation.

Parameter "Delay for switch on"

Parameter "Delay for switch off"

These two parameters are visible when "Delay switch" is selected. Set the delay time for switch on/off, execute the on/off telegram received from bus after the delay has elapsed. During delay time, receive the same telegram again, the delay time is reset.

Options: **00:00:00 ...23h:59min:59s**

Parameter "On time for flashing"

Parameter "Off time for flashing"

These two parameters are visible when "Flashing switch" is selected. Set the duration time of flashing for switch on/off.

Options: **00:00:05s ...23h:59min:59s**

Parameter "Number of flashing cycles [0..10000,0=no limit]"

This parameter is visible when "Flashing switch" is selected. Set the number of flashing cycles, a cycle includes an on and an off. 0 means the cycles is no limited. Options: **0...10000**

Parameter "Status after flashing"

This parameter is visible when "Flashing switch" is selected. Set the status after flashing. Options:

Switching off

Switching on

Unchange

Note: there is a possibility of an extra half cycle of action when "Switching on" or "Switching off" is selected.

Parameter "Control mode of flashing"

This parameter is visible when "Flashing switch" is selected. Set the control mode of flashing.

Options:

Start with"1", Stop with "0"

Start with"0", Stop with "1"

Start with"0/1", can not be stopped

Start with "1", Stop with "0": it will start flashing with value "1" and stop flashing with "0", action to the end status when stopped, which is defined via previous parameter.

Start with "0", Stop with "1": it will start flashing with value "0" and stop flashing with "1", action to the end status when stopped, which is defined via previous parameter.

Start with "0/1", can not be stopped: it will start flashing with value "0" or "1", and can not stop until the number of the flashing cycles is exhausted, or stop via the interruption from other operation.

Parameter "Duration time"

This parameter is visible when "Staircase lighting" is selected. Set the duration time of staircase lighting switch on, and switch off automatically after the time has elapsed.

Options: **00:00:05s ...23h:59min:59s**

Parameter "Time extension"

This parameter is visible when "Staircase lighting" is selected. Set whether to retrigger or extend the duration time when receive an on telegram during the time. Options:

Not retriggerable

Retriggerable

Extend duration time

Not retriggerable: ignore the telegram, switch off automatically after the time has elapsed.

Retriggerable: retrigger the duration time when receive an on telegram during the time.

Extend duration time: add up a duration time to the remaining time when receive an on telegram during the duration time. For example the duration time is set as 60s, but it is still has 40s left, and receive an on telegram at the moment, then the new duration time is 40s+60s =100s, and the staircase light will be turned off automatically after the 100s is elapsed. If receive multiple on telegrams continuously, the duration time will continue to add up until the maximum time is reached.

Parameter "Control mode of staircase lighting"

This parameter is visible when "Staircase lighting" is selected. Set the control mode of staircase lighting. Options:

Start with "1", Stop with "0"

Start with "1", no reaction with "0"

Start with "0/1", can not be stopped

Start with "1", Off with "0"

Start with "1", Stop with "0": it will switch on the staircase light with the value "1" and stop the timing with "0", keep the current lamps status until it is changed by other operations.

Start with "1", no reaction with "0": it will switch on the staircase lights with the value "1" and no reaction with "0".

Start with "0/1", can not be stopped: it will switch on the staircase lights with the value "1" or "0", and can not stop until the duration time is exhausted, or stop via the interruption from other operation.

Start with "1", Off with "0": it will switch on the staircase lights with the value "1" and switch off with "0"

Parameter "Prewarning before staircase time end"

This parameter is visible when "Staircase lighting" is selected. Set whether to prewarn before staircase light time end, and set the prewarning mode. User can be noticed before the staircase light time is about to finish. Options:

No

No, but dim-down the dimming value after end

Via object

Via flashing switching on-off

Via flashing switching on-off and object

Dim-down the dimming value

Dim-down the dimming value and via object

No: no prewarn, and switch off automatically after the time has elapsed.

No, but dim-down the dimming value after end: no prewarn, but dim down the brightness after the time has elapsed.

Via object: prewarn via the object.

Via flashing switching on-off: prewarn via a short flashing, 1s to switch on and 1s to switch off, dimming mode is Jumping.

Via flashing switching on-off and object: prewarn, refer to the explanation of the previous options.

Dim-down the dimming value: prewarn via dimming down the brightness.

Dim-down the dimming value and via object: prewarn, refer to the explanation of the previous options.

Parameter "Warning time"

This parameter is visible when the selection does not contains "No...". Set the time of prewarning.

Options: **00:00:05s...00h:59min:59s**

Note: the warning time must be less than the duration time, or it cannot set on the ETS.

Note: the warning time is contained in the startup time of staircase lighting. If switch off before the warning time, there is no prewarning.

Parameter "Value of dimming down"

This parameter is visible when the selection contains "Dim-down the dimming value....". Set the brightness value of dimming down at the end of the staircase lighting. Options: **1...100 %**

Parameter "Duration time can be changed via bus"

This parameter is visible when "Staircase lighting" is selected. Set whether the duration time can be changed via bus. Store the modified value when bus failure, recovery to the value set by parameter after download.

 The duration time receiving from bus must be longer than the warning time, otherwise it will be ignored

5.3.3.3. Parameter window "Threshold function"

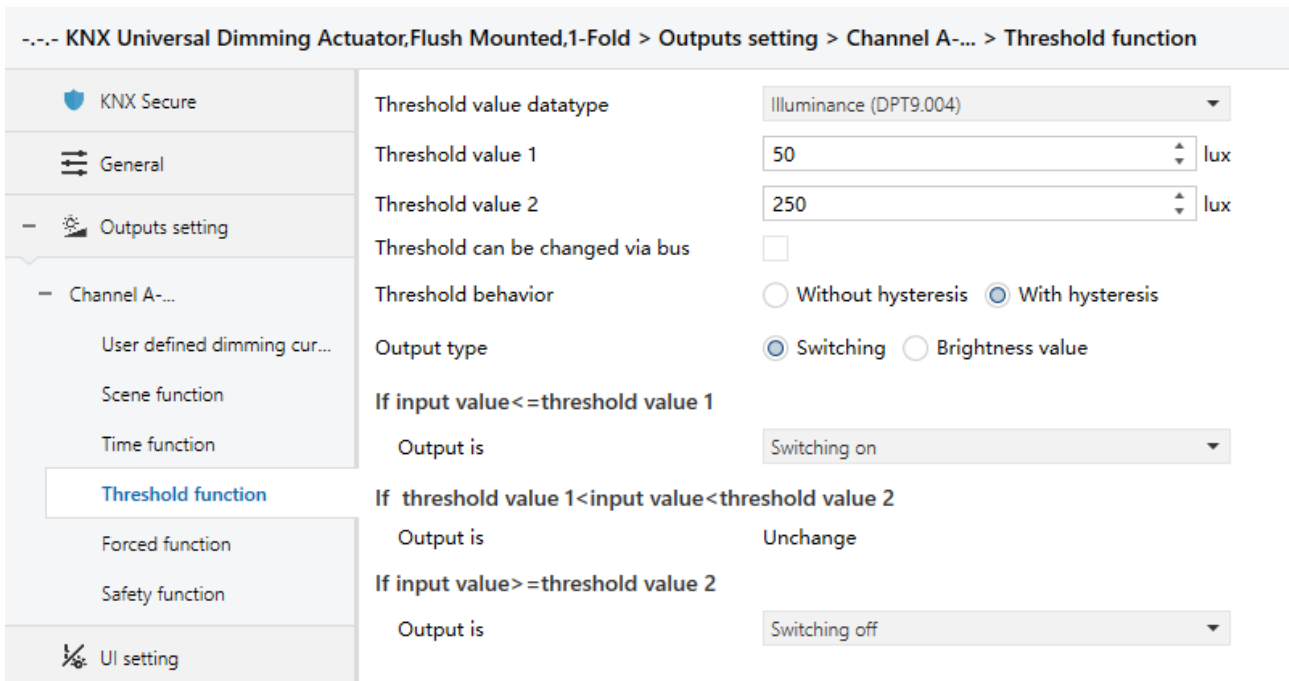

Fig.5.3.3.3 "Threshold function" parameter window

Switch on/off or dimming the brightness according to telegram from the bus and threshold set on the ETS. **Note: the brightness of threshold function is depending on the value of switch on/off.**

Parameter "Threshold value datatype"

This parameter is for setting the threshold value datatype. Options:

1byte unsigned value (DPT5.010)

1byte percentage (DPT5.001)

Temperature (DPT9.001)

Illuminance (DPT9.004)

Parameter "Threshold value 1"

Parameter "Threshold value 2"

These two parameters are for setting the threshold value 1 and 2. Options are display according to the threshold value datatype.

When 1byte unsigned value, options: **0...255**

When 1byte percentage, options: **0...100 %**

When Temperature, options: **-20...95 ° C**

When Illuminance, options: **0...65535 lux**

Note: the threshold 1 must be less than threshold 2, or they cannot be set on the ETS, as shown as following:

Threshold value 1	<input type="text" value="200"/>
Threshold value 2	<input type="text" value="200"/>

Parameter "Threshold value can be changed via bus"

This parameter is for setting whether the threshold 1 and 2 can be changed via bus.

Store the modified value when bus failure, recovery to the value set by parameter after download.

Parameter "Threshold behavior"

This parameter is for setting whether the threshold 1 and 2 with hysteresis. Options:

Without hysteresis

With hysteresis

The hysteresis can avoid the unnecessary behaviour caused by the input value if the value is between two threshold values.

Parameter "Output type"

This parameter is for setting the output type after threshold comparison. Options:

Switching

Brightness value

If input value<=threshold value 1

Set the output value when input value is less than or equal to the threshold 1. Following parameter and its options are displayed according to the output type.

Parameter "Output is"

This parameter is visible when "Switching" is selected. Options:

Switching off

Switching on

Unchange

Parameter "Dimming value is"

This parameter is visible when "Brightness value" is selected. Options: **0...100 %**

If threshold value 1 < input value < threshold value 2

Set the output value when input value is between the threshold 1 and 2. Output parameter and its options are displayed according to the output type, as above explanation.

Note: when with hysteresis, the output is only **Unchange**

If input value >= threshold value 2

Set the output value when input value is greater than the threshold 2. Output parameter and its options are displayed according to the output type, as above explanation.

5.3.3.4. Parameter window "Forced function"

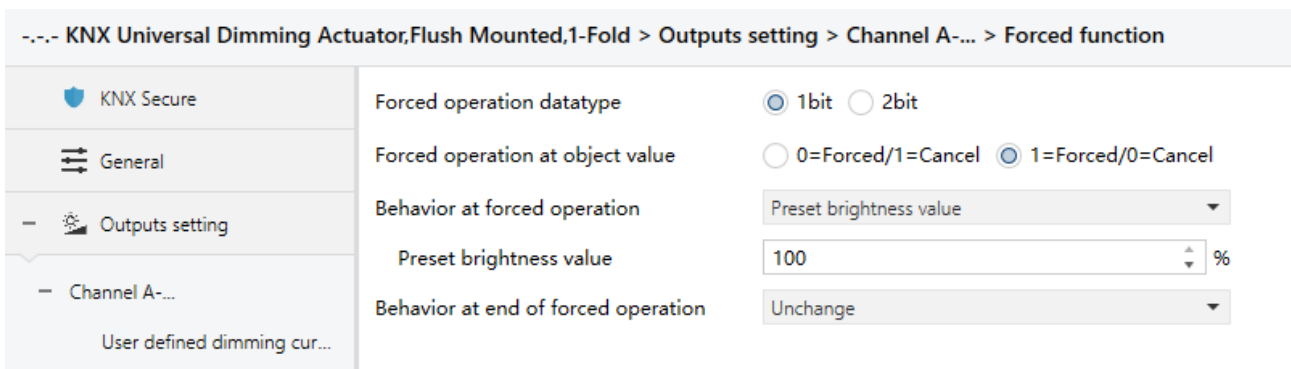

1bit

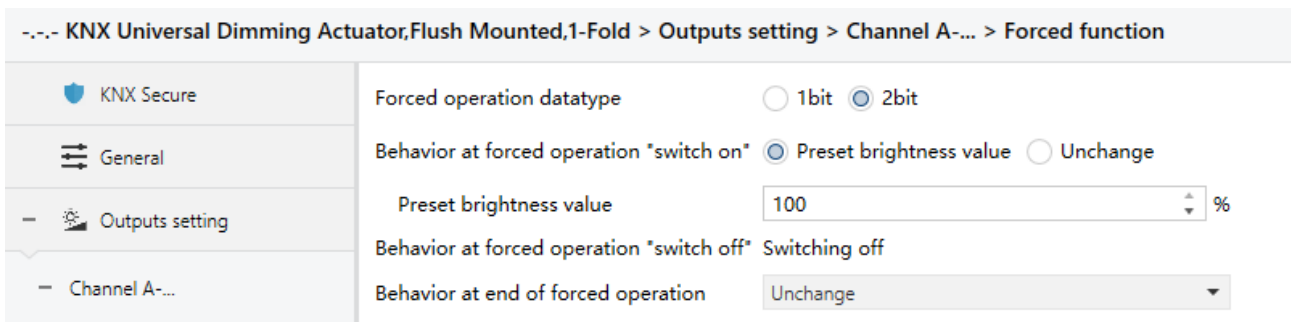

2bit

Fig.5.3.3.4 "Forced function" parameter window

The lamp can be forcibly fixed at a brightness in some special situations. Forced function has the highest priority. Ignore the normal control telegram received from bus when during in forced or safety operation.

Parameter "Forced operation datatype"

This parameter is for setting the datatype of forced operation. Options:

1bit

2bit

Parameter "Forced operation at object value"

This parameter is visible when 1bit. Set the object value for activating or canceling the forced.

Options:

0=Forced/1=Cancel

1=Forced/0=Cancel

Parameter "Behavior at forced operation"

This parameter is visible when 1bit. Set behavior at forced operation. Options:

Switching off

Preset brightness value

Unchange

Parameter "Preset brightness value"

This parameter is visible when "Preset brightness value" is selected. Set the preset brightness value.

Options: **1...100 %**

Parameter "Behavior at forced operation "switch on""

This parameter is visible when 2bit. Set the behavior at forced operation "switch on" when receive telegram value 3 from 2bit. Options:

Preset brightness value

Unchange

Parameter "Preset brightness value"

This parameter is visible when "Preset brightness value" is selected. Set the preset brightness value.

Options: **1...100 %**

Parameter "Behavior at forced operation "switch off""

This parameter is visible when 2bit. Set the behavior at forced operation "switch off" when receive telegram value 2 from 2bit. Option is only **Switching off**

Parameter "Behavior at end of forced operation"

This parameter is for setting the behavior at end of forced operation. **Note: the telegram values 0/1**

from 2bit are used to cancel forced operation. Options:

Switching off

Preset brightness value

Unchange

1. When receive a telegram to end forced operation, it is valid if the forced operation has been activated before, otherwise ignore the telegram.

2. When a telegram to end forced operation is valid, if there is another priority (safety operation) active in the device, execute this action of this priority; otherwise, ignore the end telegram and execute the action of forced operation.

Parameter "Preset brightness value"

This parameter is visible when "Preset brightness value" is selected. Set the preset brightness value.

Options: **1...100 %**

5.3.3.5. Parameter window "Safety function"

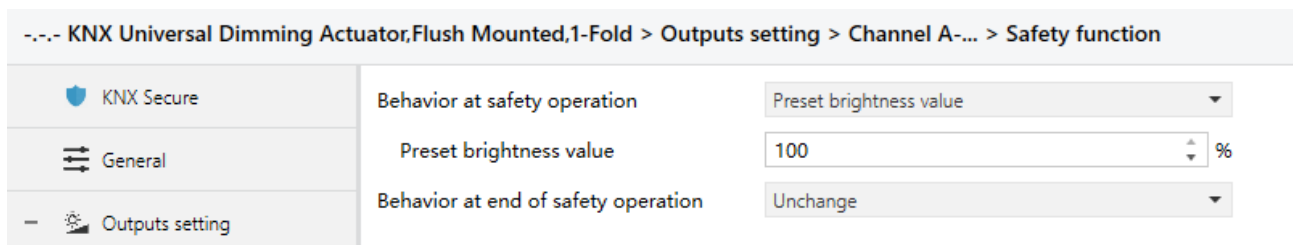

Fig.5.3.3.5 "Safety function" parameter window

Safety function can work with external sensor and perform dimming behaviour in some emergency situations. Safety function has the second highest priority and only lower than forced function.

Parameter "Behavior at safety operation"

Parameter "Behavior at end of safety operation"

These two parameters are for setting the behavior for activating or canceling the safety operation.

Options:

Switching off

Preset brightness value

Unchange

Parameter "Preset brightness value"

This parameter is visible when "Preset brightness value" is selected. Set the preset brightness value.

Options: **1...100 %**

1. When receive an end telegram, it is valid if the safety operation has been activated before, otherwise ignore the telegram.

2. When the end telegram is valid, if there is another priority (forced operation) active in the device, execute this action of this priority; otherwise, ignore the cancel telegram and execute the action of safety operation.

5.4.Parameter window "UI setting"

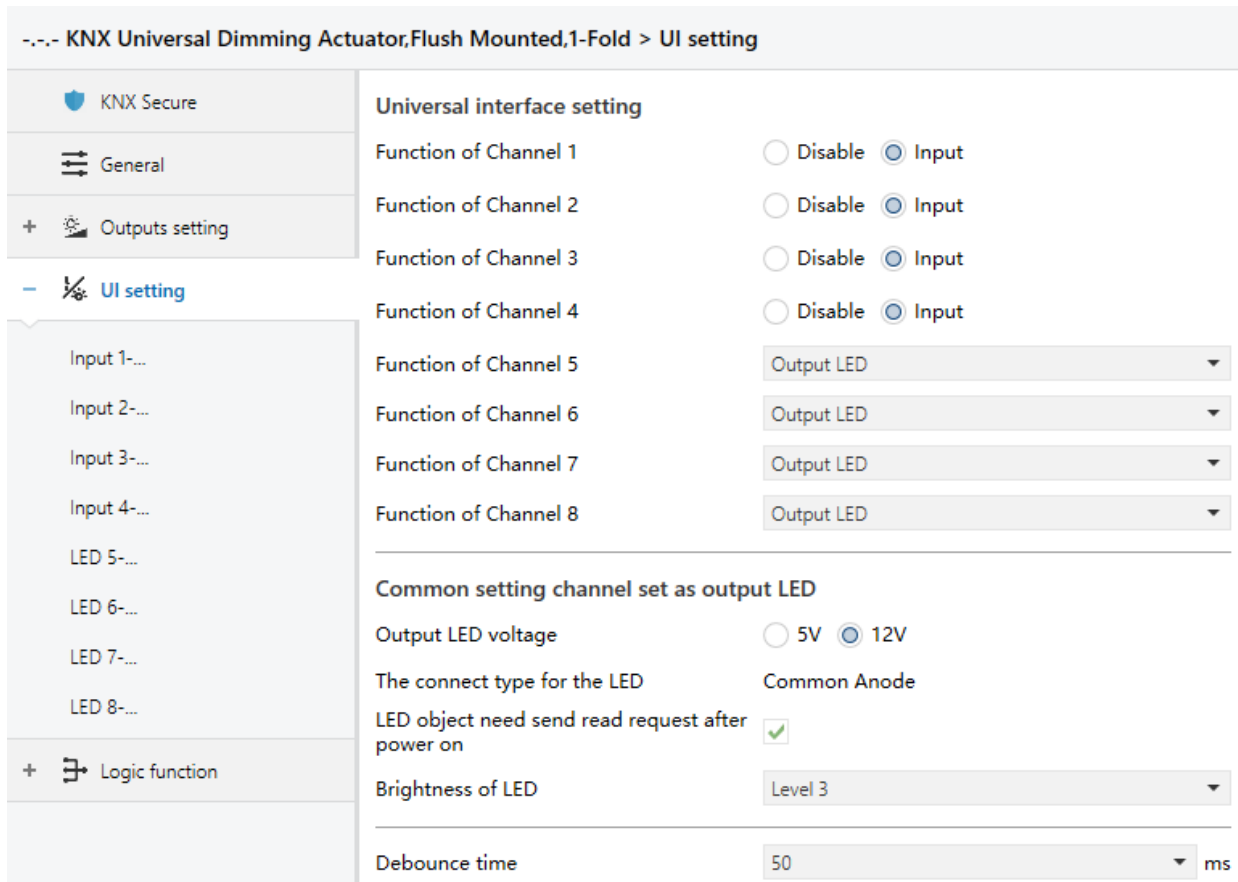

Fig.5.4 "UI setting" parameter window

Universal interface setting

Parameter "Function of Channel x"(x=1~8)

This is for setting the function of channel x. Options:

Disable

Input

Output LED

Note: up to support 8 channels, channel 1-4 is only input while 5-8 can be configured as input or output LED.

Note: all object values are 0 after bus recovery or download.

Common setting channel set as output LED

Parameter "Output LED voltage"

This parameter is for setting the voltage of the output LED and the selection according to the power supply voltage of the connected LED. Options:

5V

12V

Parameter "The connect type for the LED"

This parameter is for setting the connect type for the LED, option is only **Common Anode**

Parameter "LED object need send read request after power on"

This parameter is for setting whether the LED object will send a read request after bus recovery or download.

When enabled, send read request, LED will indicate according to the response value, if there is no response, there will be no indication.

When disabled, not send read request, and following parameter is visible:

Parameter "Initial status indication"

This parameter is for setting the initial LED status. Options:

No

As status as object value "0"

No: no indication.

As status as object value"0": LED indicates according to the status of object value 0. If "Control by external object" is selected for LED x indication and the object datatype is 1byte, there is no indication.

Parameter "Brightness of LED"

This parameter is for setting the brightness of LED indication, if there is no indication, it is off.

Options:

Level 1

Level 2

Level 3

Parameter "Debounce time"

This parameter is for setting the debounce time to avoid the unnecessary operations which is caused by the contact triggered multiple times in bouncing time, debounce time is the valid time of the contact operation. Options:

50ms

70ms

100ms

150ms

5.4.1. Parameter window "Input x"

Dry contact input detection support the functions of switch, dimming, value output, scene control, blind, shift register, multiple operation and delay mode. Each input function can be set individually. The following takes an input as an example for the explanation of parameters.

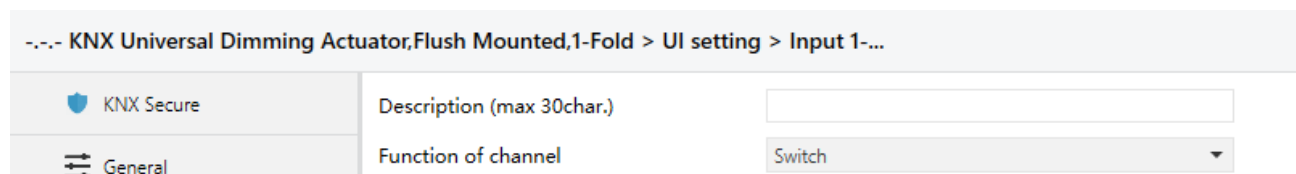

Fig.5.4.1 "Input x-..." Parameter window

Parameter "Description (max 30char.)"

This parameter is for setting the name description of the input channel, up to 30 characters.

Parameter "Function of channel"

This parameter is for setting the function of channel. Options:

Switch

Blind

Dimming

Shift register

Value output

Multiple operation

Scene control

Delay mode

5.4.1.1. Parameter window "Switch"

"Switch" parameter setting interface is shown as in Fig.5.4.1.1, user can press or release the contact to send a switch telegram with this application.

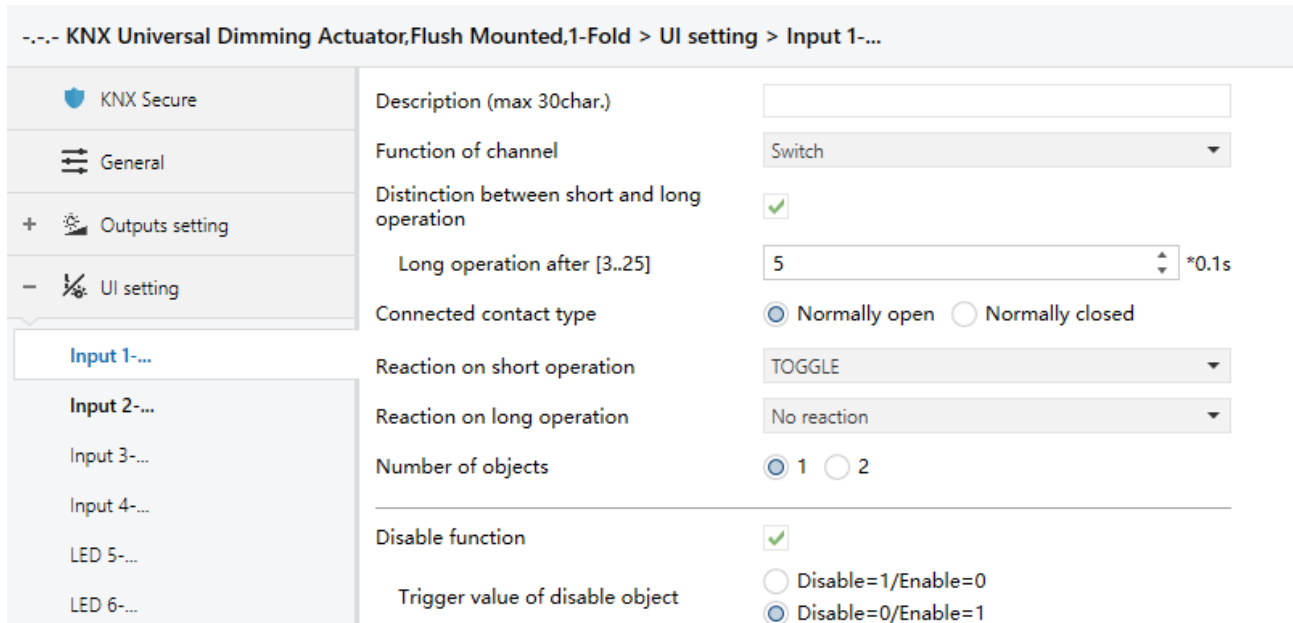

Fig.5.4.1.1 "Input x-Switch" parameter window

Parameter "Distinction between short and long operation"

This parameter defines whether the contact use long/short operation or not. If select to distinguish, you should press the contact for a certain time, so it can be identified as long operation and execute corresponding action.

Parameter "Long operation after [3..25]"

This parameter is visible when select to distinguish long/short operation. Set the valid time for long operation. So, when you press longer than the time set here, it will be identified as long operation, otherwise, it will be taken as short operation. Options: **3...25 *0.1s**

Parameter "Connect contact type"

This parameter is for setting the type of connected contacts. Options:

Normally open

Normally closed

Parameters explained in this chapter is taken **Normally open** as an example, operation of **Normally closed** is reversed.

Parameter "Reaction on short operation" / "Reaction on press the contact"

Parameter "Reaction on long operation" / "Reaction on release the contact"

These parameters are for setting the reaction on press/release the contact or on short/long operation. The object values are updated immediately when the input is confirmed. Options:

No action

ON

OFF

TOGGLE

No action: no telegram to be sent.

ON: send on telegram.

OFF: send off telegram.

TOGGLE: each operation will toggle the switch between on and off. For example, if send an On telegram(or received) at the last, then the next operation will trigger an Off telegram. When the contact is operated again, it will send an On telegram, etc. So the contact will always remember the previous status and covert to opposite value during next operation. When the device is powered on for the first time or restarted after downloading, the default value for " Switch " is 0, meaning the first operation is ON.

Parameter "Send object value after bus recovery (valid if reaction is not toggle)"

This parameter is visible when select to not distinguish long/short operation. Set whether to send the current value of object "Switch" to the bus after bus recovery.

If enabled, send the current value of object "Switch" to the bus after bus recovery, but it is only applied to the option is not "Toggle" or "No reaction", and if any one of the parameters select these two options can not send value to the bus.

Parameter "Number of objects"

This parameter is for setting the number of objects to control switch, 1 common object or 2 separate objects. Options:

1

2

Parameter "Disable function"

This parameter for setting whether to enable the disable function of the contact. The disable status is activated by default after download. Options:

Parameter "Trigger value of disable object"

This parameter is visible when previous parameter is enabled. Set the trigger value of disable object. Options:

Disable=1/enable=0

Disable=0/enable=1

These same parameters will not be explained in next chapters, their usage are similar.

5.4.1.2.Parameter window "Dimming"

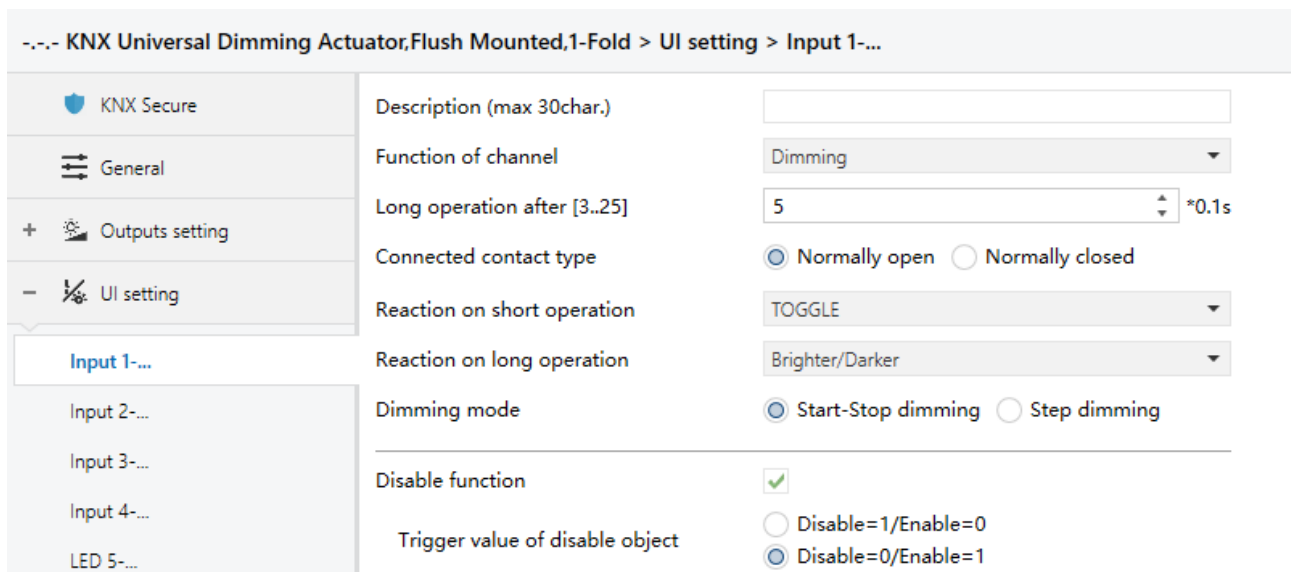

Fig.5.4.1.2 "Input x- Dimming"parameter window

Parameter "Reaction on short operation"

This parameter is for setting the reaction on short operation. Options:

No action

ON

OFF

TOGGLE

No action: no telegram to be sent.

ON: send on telegram.

OFF: send off telegram.

TOGGLE: each operation will toggle the switch between on and off. When the device is powered on for the first time or restarted after downloading, the default value for "Switch" is 0, meaning the first operation is ON.

Parameter "Reaction on long operation"

This parameter is for setting the reaction on long operation to send relative dimming value.

Options:

No action

Brighter

Darker

Brighter/Darker

No action: no telegram to be sent.

Brighter: send the dimming up value.

Darker: send the dimming down value.

Brighter/darker: each operation will toggle the dimming between up and down. When the device is powered on for the first time or restarted after downloading, the default value for "Dimming" is 0, meaning the first operation is dim up the brightness.

Note: In the options of "TOGGLE" and "Brighter/Darker", there are a linkage between the received switch status and the dimming. For example, if receive an On value from object "Switch" at the last, then it will dim down the brightness in next dimming operation. If receive an Off value first, then it will dim up the brightness in next dimming operation.

Parameter "Dimming mode"

This parameter is for setting the mode of relative dimming. Options:

Start-stop dimming

Step dimming

Start-stop dimming: the dimming mode is start-stop, i.e. a telegram of dimming up or down will be sent when the dimming starts, and a stop telegram will be sent when dimming ends. The dimming telegram is no need to be sent cyclically.

Steps dimming: the dimming mode is step and the dimming telegram is sent cyclically. When dimming ends, a stop dimming telegram will be sent immediately.

Parameter "Step size"

This parameter is visible when "Step dimming" is selected. Set the brightness (%) that can be changed by the dimming telegrams sent cyclically. Options:

100%

50%

...

1.56%

Parameter "Interval of tele. Cyclic send [0..25] (0=send once)"

This parameter is visible when "Step dimming" is selected. Set the interval for cyclically sending the telegram of dimming. Options: **0..25 *0.1s, 0=send once**

5.4.1.3. Parameter window "Value output"

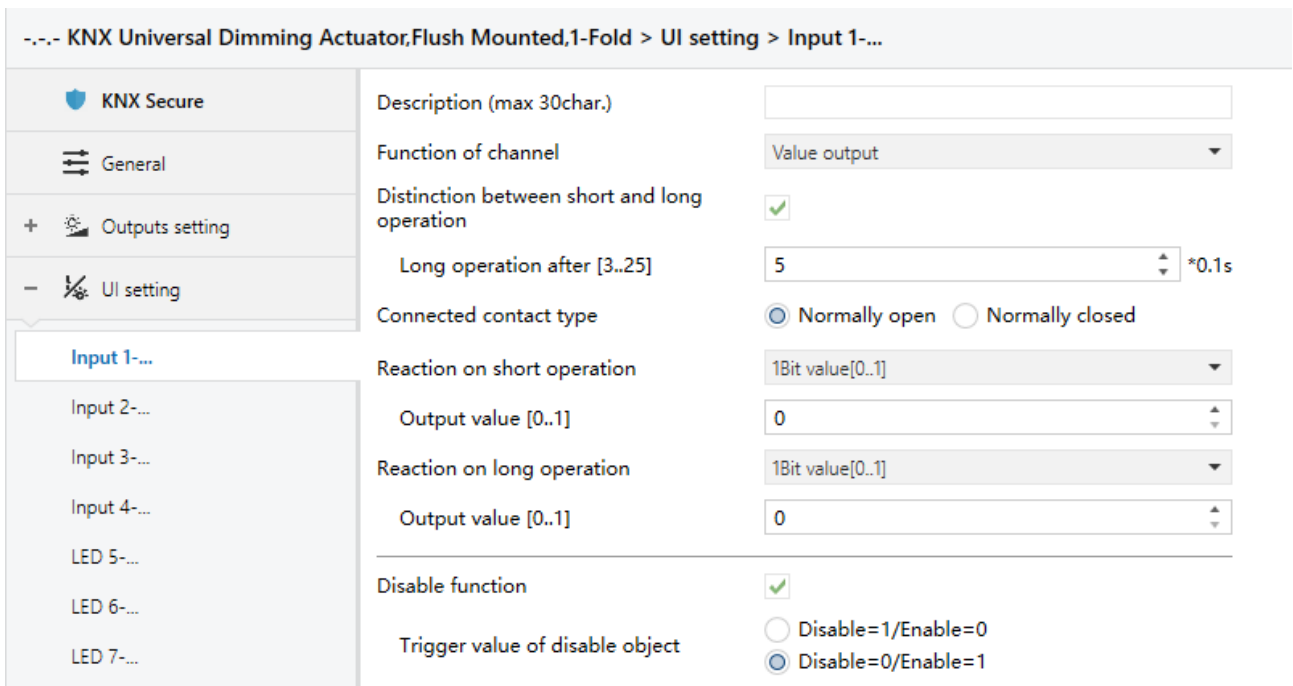

Fig.5.4.1.3 "Input x)- Value output" parameter window

Parameter "Reaction on short operation" / "Reaction on press the contact"

Parameter "Reaction on long operation" / "Reaction on release the contact"

These parameters are for setting the object datatype to be sent when on press/release the contact or on short/long operation. Options:

No reaction

1bit value [0..1]

2bit value [0..3]

4bit value [0..15]

1byte value [0..255]

2byte value [0..65535]

Parameter "Output value [...]"

These parameters are for setting the output value when execute the operation. Range of value is according to the selection of previous parameter.

5.4.1.4. Parameter window "Scene control"

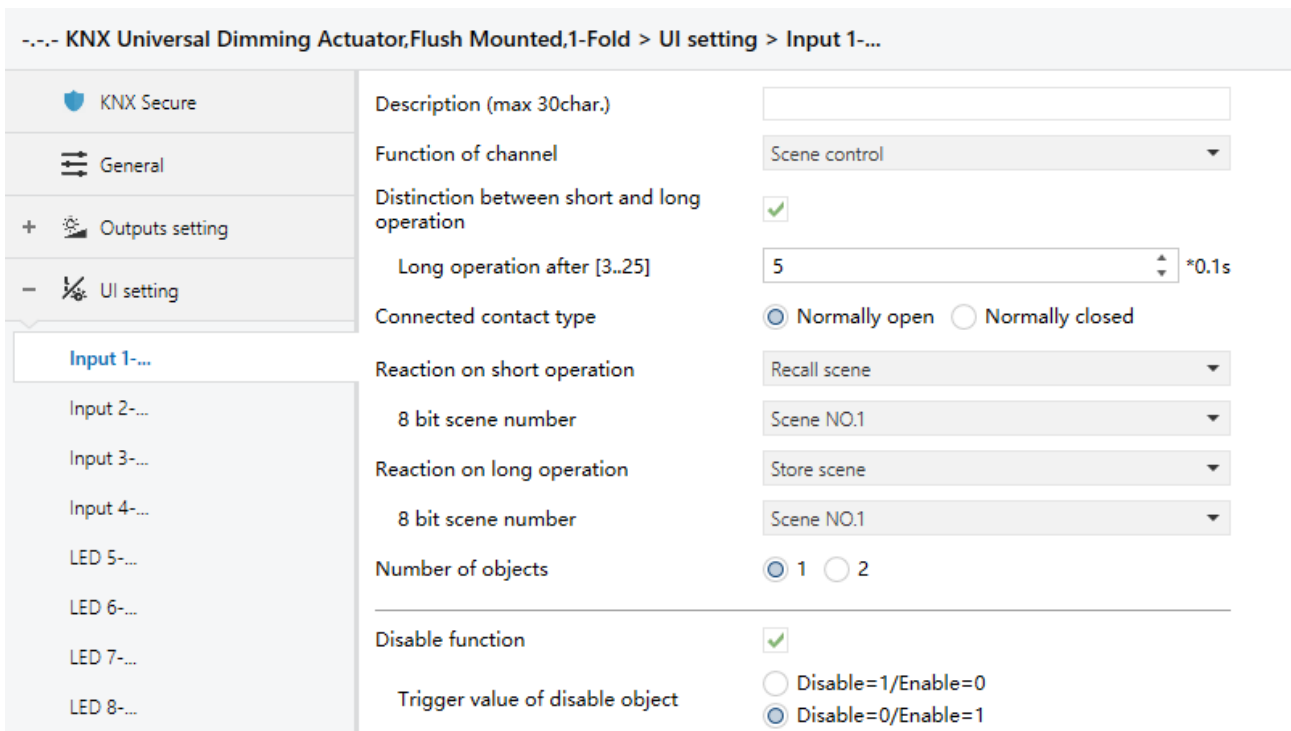

Fig.5.4.1.4 "Input x- Scene control" parameter window

Parameter "Reaction on short operation" / "Reaction on press the contact"

Parameter "Reaction on long operation" / "Reaction on release the contact"

These parameters are for setting the reaction on press/release the contact or on short/long operation, to recall or store scene. Options:

No reaction

Recall scene

Store scene

Parameter "8 bit scene number"

This parameter is for setting the scene number. Options: **Scene NO.1~64**, corresponding telegram is 0~63.

Parameter "Number of objects"

This parameter is for setting the number of objects to recall/store scene, 1 common object or 2 separate objects. Options:

1

2

5.4.1.5. Parameter window "Blind"

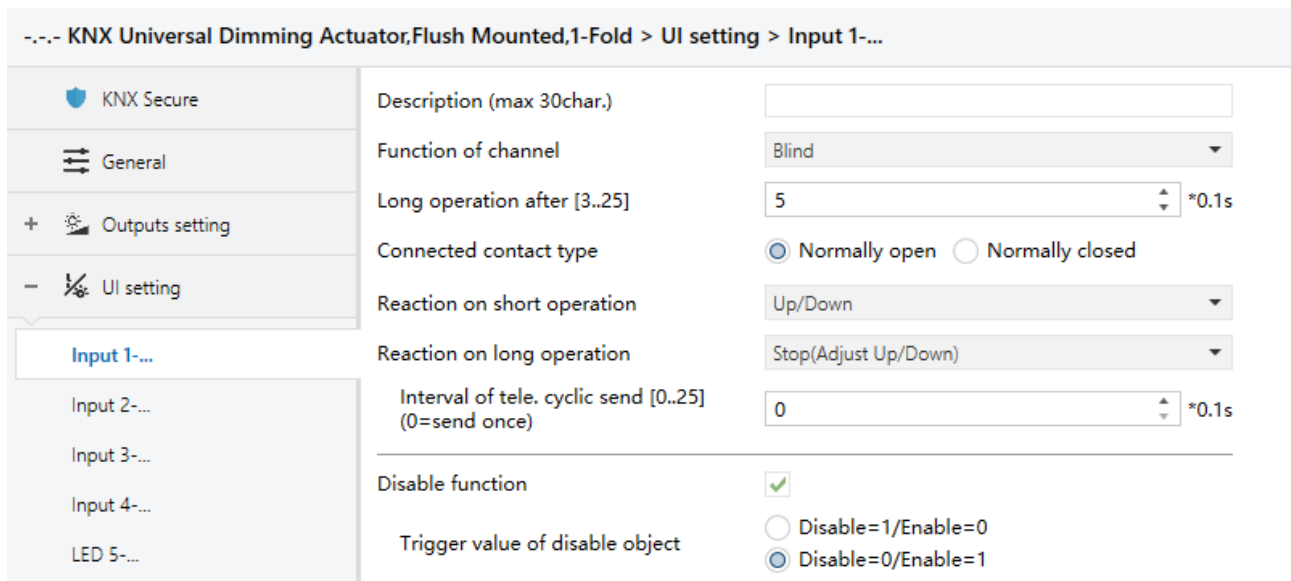

Fig.5.4.1.5 "Input x- Blind" parameter window

Parameter "Reaction on short/long operation"

These parameters are for setting the reaction on short/long operation. Options:

No action

Up

Down

Up/Down

Stop (Adjust Up)

Stop (Adjust Down)

Stop (Adjust Up/Down)

No action: no telegram to be sent.

Up: the blinds will be opened or moved up.

Down: the blinds will be closed or moved down.

Up/Down: alternately open/close or move up/down the blinds. When the device is powered on for the first time or restarted after downloading, the default value for "Up/Down, Blind" is 0, meaning the first operation is closing or moving down the blinds.

Stop (Adjust Up): stop the blind movement or move up the angle of blinds.

Stop (Adjust Down): stop the blind movement or move down the angle of blinds.

Stop (Adjust Up/Down): stop the blind movement or move up/down the angle of blinds alternately. When the device is powered on for the first time or restarted after downloading, the default value for "Stop/Adjust Blind" is 0, meaning the first operation is stop or move down the angle of blinds.

Parameter "Interval of tele. cyclic send [0..25] (0=send once)"

This parameter is visible when previous parameter is selected "Stop...". Set the interval for cyclically sending the telegram of blinds angle adjustment. Options: **0..25,0=send once**

5.4.1.6. Parameter window "Shift register"

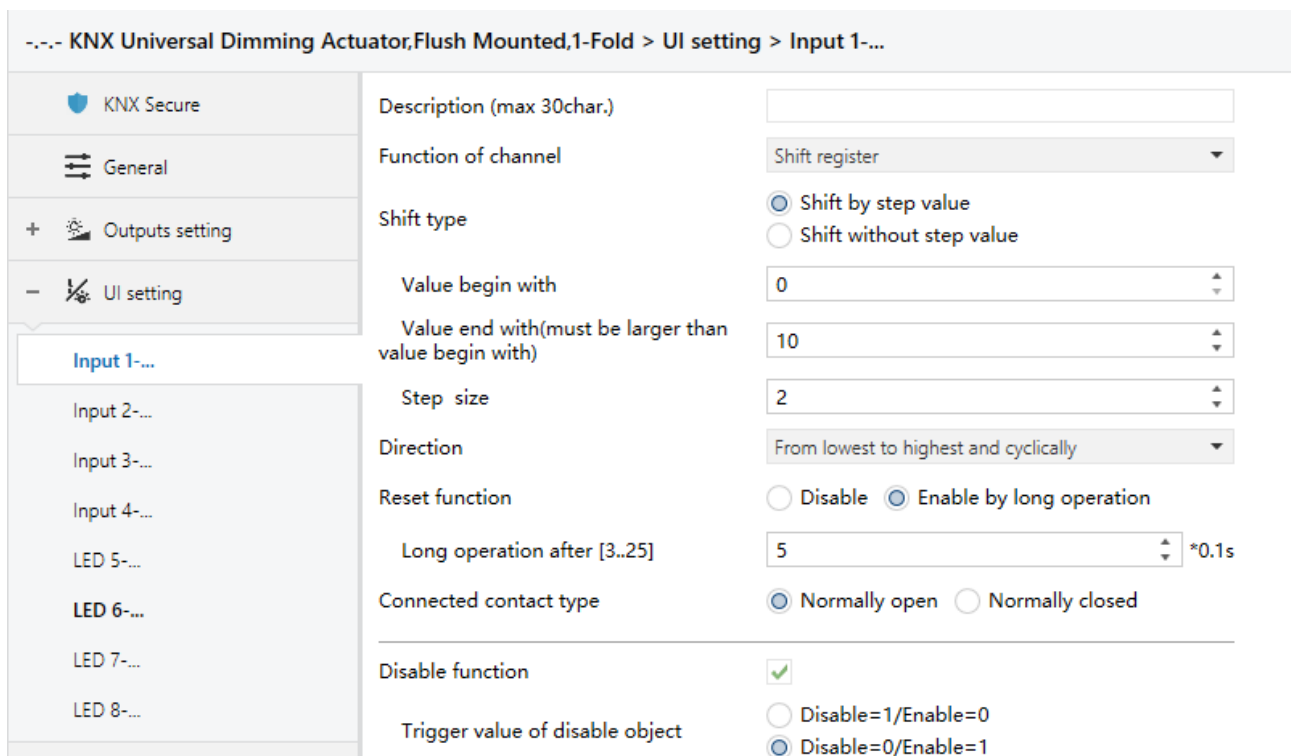

Fig.5.4.1.6 "Input x- Shift register" parameter window

Parameter "Shift type"

This parameter is for setting the shift type. Options:

Shift by step value

Shift without step value

Shift by step value: set the lowest and highest value of shift, as well as the value increased (from lowest to highest) or decreased (from highest to lowest) from each shift.

Shift without step value: when there is no step value, set the actual value sent by each shift (max. 10 values), operate a time and send a value.

Three parameters as follow are visible when "Shift by step value" is selected

Parameter "Value begin with"

This parameter is for setting the lowest value of the shift. Options: **0..240**

Parameter "Value end with(must be larger than value begin with)"

This parameter is for setting the highest value of the shift. Options: **1..250**

Note: the highest value must be larger than lowest value, if not, it can not set on the ETS and display the red box, as shown as following:

Value begin with	<input type="text" value="4"/>
Value end with(must be larger than value begin with)	<input type="text" value="1"/>

Parameter "Step size"

This parameter is for setting the increase (from low to high) or decrease (from high to low) value from each shift. Options: **0..240**

Parameters as follow are visible when "Shift without step value" is selected

Parameter "Object datatype"

This parameter is for setting the object datatype for the shift object. Options:

1 byte unsigned value

Scene number

HVAC mode

1 byte percentage

Parameter "Shift number"

This parameter is for setting the number of shift, up to set maximum 10 values.

When "1 byte unsigned value", "Scene number" or "1 byte percentage" is selected, options: **0/1/2/.../10**

When "HVAC mode" is selected, options: **1/2/3/4**

Parameter "Value x"(x=1~10 or x=1~4)

This parameter is for setting the value when each shift operation to send.

When "1byte unsigned value" is selected, options: **0...255**

When "Scene number" is selected, options:

Scene NO.1

Scene NO.2

Scene NO.3

...

Scene NO.64

When "HVAC mode" is selected, options:

Comfort mode

Standby mode

Economy mode

Frost/heat protection

When "1byte percentage" is selected, options:

0%

1%

...

100%

Parameter "Direction"

This parameter is for setting the shift direction. Options:

From lowest to highest and stop to the end

From highest to lowest and stop to the begin

From lowest to highest and cyclically

From highest to lowest and cyclically

From lowest to highest and stop to the end: Shift from low to high.

From highest to lowest and stop to the begin: Shift from high to low.

From lowest to highest and cyclically: once to the end value, shift direction starts over again and

constantly cycling from low to high operation.

From highest to lowest and cyclically: once to the start value, shift direction starts over again and constantly cycling from high to low operation.

Parameter "Reset function"

This parameter is for setting whether to enable shift reset function. Options:

Disable

Enable by long operation

Disable: not possible to reset shift;

Enable by long operation: possible to reset shift by long operation, when reset, shift will be restarted.

5.4.1.7. Parameter window "Multiple operation"

--- KNX Universal Dimming Actuator, Flush Mounted, 1-Fold > UI setting > Input 1-...

KNX Secure	Description (max 30char.)	<input type="text"/>
General	Function of channel	Multiple operation
+ Outputs setting	Distinction between short and long operation	<input checked="" type="checkbox"/>
- UI setting	Long operation after [3..25]	5 *0.1s
Input 1-...	Connected contact type	<input checked="" type="radio"/> Normally open <input type="radio"/> Normally closed
Input 2-...	Object type for object1	1Bit_On/Off
Input 3-...	Function of short operation	TOGGLE
Input 4-...	Function of long operation	TOGGLE
LED 5-...	Object type for object2	1Bit_On/Off
LED 6-...	Function of short operation	TOGGLE
LED 7-...	Function of long operation	TOGGLE
LED 8-...	Object type for object3	1Bit_On/Off
	Function of short operation	TOGGLE
	Function of long operation	TOGGLE
+ Logic function	Object type for object4	1Bit_On/Off
	Function of short operation	TOGGLE
	Function of long operation	TOGGLE
	Disable function	<input checked="" type="checkbox"/>
	Trigger value of disable object	<input type="radio"/> Disable=1/Enable=0 <input checked="" type="radio"/> Disable=0/Enable=1

Fig.5.4.1.7 "Input x- Multiple operation" parameter window

Parameter "Object type for object x"(x=1...4)

These parameters are for setting the object datatype to be sent when on press the contact or on short/long operation. Options:

- Disable**
- 1Bit_On/Off**
- 1Bit_Up/Down**
- 1Byte_RecallScene**
- 1Byte_StoreScene**
- 1Byte_Percentage**

1Byte_Unsigned value

1Bit_On/Off: When the device is powered on for the first time or restarted after downloading, the default value for " On/Off" is 0, meaning the first operation is ON.

1Bit_Up/Down: When the device is powered on for the first time or restarted after downloading, the default value for " Up/Down" is 0, meaning the first operation is closing or moving down the blinds.

Parameter "Function of short operation" /"Function of press the contact"

Parameter "Function of long operation"

These parameters are for setting the specific values to send when perform the operation, either no action or sending value (the specific value will be set in next parameter).

Parameter "Value 1/2 (Scene NO./Percentage/Unsigned value)"

These parameters are visible when "1Byte_RecallScene", "1Byte_StoreScene","1Byte_Percentage"or "1Byte_Unsigned value" is selected. Set the sending values when perform operations. The ranges of value 1/2 are depending on the datatype selected by the parameter before last one.

5.4.1.8. Parameter window "Delay mode"

--- KNX Universal Dimming Actuator, Flush Mounted, 1-Fold > UI setting > Input 1-...

KNX Secure	Description (max 30char.)	<input type="text"/>
General	Function of channel	Delay mode <input type="button" value="v"/>
+ Outputs setting	Distinction between short and long operation	<input checked="" type="checkbox"/>
- UI setting	Long operation after [3..25]	5 <input type="button" value="v"/> *0.1s
Input 1-...	Connected contact type	<input checked="" type="radio"/> Normally open <input type="radio"/> Normally closed
Input 2-...	Object type for short operation	1Bit_On/Off <input type="button" value="v"/>
Input 3-...	Send mode	No action when press, delay then send value1 <input type="button" value="v"/>
Input 4-...	Delay time [0..6500]	10 <input type="button" value="v"/> s
LED 5-...	Value 1	<input checked="" type="radio"/> 0 <input type="radio"/> 1
LED 6-...	Value 2	<input type="radio"/> 0 <input checked="" type="radio"/> 1
LED 7-...	Object type for long operation	1Bit_On/Off <input type="button" value="v"/>
LED 8-...	Send mode	No action when press, delay then send value1 <input type="button" value="v"/>
	Delay time [0..6500]	10 <input type="button" value="v"/> s
	Value 1	<input checked="" type="radio"/> 0 <input type="radio"/> 1
	Value 2	<input type="radio"/> 0 <input checked="" type="radio"/> 1
+ Logic function	Disable function	<input checked="" type="checkbox"/>
	Trigger value of disable object	<input type="radio"/> Disable=1/Enable=0 <input checked="" type="radio"/> Disable=0/Enable=1

Fig.5.4.1.8 "Input x- Delay mode" parameter window

Parameter "Object type of press the contact/ Object type of short operation/ Object type of long operation"

These parameters are for setting the object datatype to be sent when on press the contact or on short/long operation. Options:

Disable

1Bit_On/Off

4Bit_Dimming

1Byte_Unsigned value

Parameter "Send mode"

This parameter is for setting the send mode. Options:

No action when press, delay then send value 1

No action when press, delay then send value 2

Send value 1 when press, delay then send value 2

Send value 2 when press, delay then send value 1

Parameter "Delay time [0..6500]"

This parameter is for setting the delay time. Options: **0..6500 s**

Parameter "value1/2 [...]"

This parameter is for setting the value 1/2 to send. The ranges of value 1/2 are depending on the datatype selected by the parameter before last one.

5.4.2.Parameter window "LED x"

--- KNX Universal Dimming Actuator, Flush Mounted, 1-Fold > UI setting > LED 5-...

<ul style="list-style-type: none"> KNX Secure General Outputs setting UI setting 	Description (max 30char.) <input type="text"/> Status LED indication Control by external object ▼ External object datatype <input checked="" type="radio"/> 1Bit <input type="radio"/> 1Byte When object value="0", LED is <input checked="" type="radio"/> OFF <input type="radio"/> ON When object value="1", LED is <input type="radio"/> OFF <input checked="" type="radio"/> ON
--	---

Control by external object

--- KNX Universal Dimming Actuator, Flush Mounted, 1-Fold > UI setting > LED 5-...

<ul style="list-style-type: none"> KNX Secure General 	Description (max 30char.) <input type="text"/> Status LED indication Always on ▼
---	--

Always on

Fig.5.4.2 "LED x"Parameter window

Parameter "Status LED indication"

This parameter is for setting the LED indication status. Options:

None

Control by external object

Always on

Parameters as follow are visible when "Control by external object" is selected:

Parameter "External object datatype"

This parameter is for setting the external object datatype. Options:

1bit

1byte

Parameter "When object value = '0/1', LED is"

These parameters are visible when 1bit. LED indicates according the the receiving telegram "1" or "0" from the object.

OFF

ON

Parameter "Threshold value is"

This parameter is visible when 1byte. Set the threshold value of LED indication. Options: **1...255**

Parameter "If object value < threshold value, LED is"

This parameter is visible when 1byte. Set the status of LED indication when the object value is less than threshold value. Options:

OFF

ON

Parameter "If object value = threshold value, LED is"

This parameter is visible when 1byte. Set the status of LED indication when the object value is equal to threshold value. Options:

OFF

ON

Parameter "If object value > threshold value, LED is"

This parameter is visible when 1byte. Set the status of LED indication when the object value is greater than threshold value. Options:

OFF

ON

5.5.Parameter window "Logic"

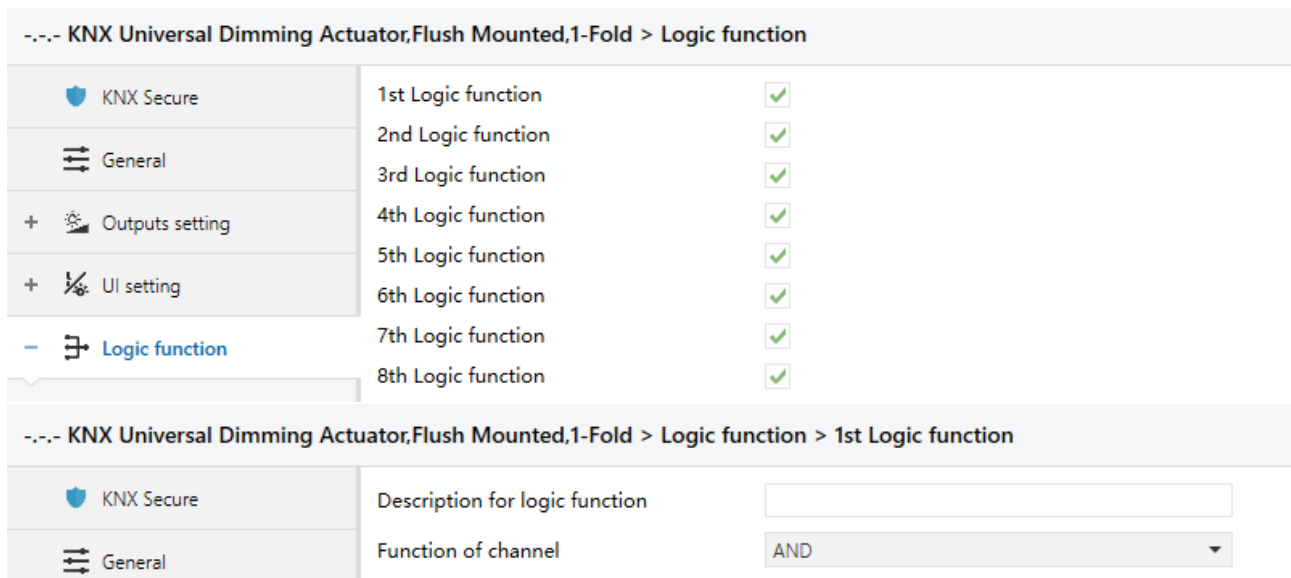

Fig.5.5 "Logic function setting" parameter window

Parameter "1st/2nd/3rd... Logic function"

This parameter is for setting the setting interface of logic function, display corresponding logic function page when select. Up to enable 8 logic functions.

Parameter "Description for logic function"

This parameter is for setting the name description for logic function, up to input 30 characters.

Parameter "Function of channel"

This parameter is for setting function of the channel. Options:

- AND**
- OR**
- XOR**
- Gate forwarding**
- Threshold comparator**
- Format convert**
- Gate function**
- Delay function**
- Staircase lighting**

AND/OR/XOR: as the parameter is similar to the communication object (only the logic algorithm is different), the following parameters taking one options for example.

5.5.1. Parameter window "AND/OR/XOR"

--- KNX Universal Dimming Actuator, Flush Mounted, 1-Fold > Logic function > 1st Logic function

KNX Secure	Description for logic function	<input type="text"/>
General	Function of channel	AND <input type="text"/>
+ Outputs setting	Input a	Disconnected <input type="text"/>
+ UI setting	Default value	<input checked="" type="radio"/> 0 <input type="radio"/> 1
- Logic function	Input b	Disconnected <input type="text"/>
1st Logic function	Default value	<input checked="" type="radio"/> 0 <input type="radio"/> 1
2nd Logic function	Input c	Disconnected <input type="text"/>
3rd Logic function	Default value	<input checked="" type="radio"/> 0 <input type="radio"/> 1
4th Logic function	Input d	Disconnected <input type="text"/>
5th Logic function	Default value	<input checked="" type="radio"/> 0 <input type="radio"/> 1
6th Logic function	Input e	Disconnected <input type="text"/>
7th Logic function	Default value	<input checked="" type="radio"/> 0 <input type="radio"/> 1
8th Logic function	Input f	Disconnected <input type="text"/>
	Default value	<input checked="" type="radio"/> 0 <input type="radio"/> 1
	Input g	Disconnected <input type="text"/>
	Default value	<input checked="" type="radio"/> 0 <input type="radio"/> 1
	Input h	Disconnected <input type="text"/>
	Default value	<input checked="" type="radio"/> 0 <input type="radio"/> 1
	Result is inverted	<input checked="" type="radio"/> No <input type="radio"/> Yes
	Read input object value after bus voltage recovery	<input checked="" type="radio"/> No <input type="radio"/> Yes
	Output send when	<input checked="" type="radio"/> Receiving a new telegram <input type="radio"/> Every change of output object
	Send delay time: Base	None <input type="text"/>
	Factor: 1..255	1 <input type="text"/>

Fig.5.5.1 "AND/OR/XOR" parameter window

Parameter "Input a/b/c/d/e/f/g//h"

This parameter is for setting whether input x to calculate, whether to normally calculate or inverted calculate. Options:

Disconnected

Normal

Inverted

Disconnected: not to calculate;

Normal: to directly calculate the input value;

Inverted: invert the input value, then to calculate. **Note: not to invert the initiate value.**

Parameter "Default value"

This parameter is for setting the initial value of logic input x. Options:

0

1

Parameter "Result is inverted"

This parameter is for setting whether to invert the logic calculation result. Options:

No

Yes

No: output directly;

Yes: output after inverting.

Parameter "Read input object value after voltage recovery"

This parameter is for setting whether to send the read request to the logic input object after device voltage recovery or finish programming. Options:

No

Yes

Parameter "Output send when"

This parameter is for setting the condition of sending logic result. Options:

Receiving a new telegram

Every change of output object

Receiving a new telegram: every time the object received a new input value will the logic result be sent to the bus;

Every change of output object: only when logic result has changed will it be sent to the bus.

Tip: when in the first time to logic calculate, the logic result will be sent even if it has no change.

Parameter "Send delay time"

Base: **None**

0.1s

1s

...

10s

25s

Factor: 1..255

This parameter is for setting the delay time for sending the logic calculation result to the bus. Delay time = Base × Factor, if option "None" of Base is selected, then there is no delay.

5.5.2. Parameter window "Gate forwarding"

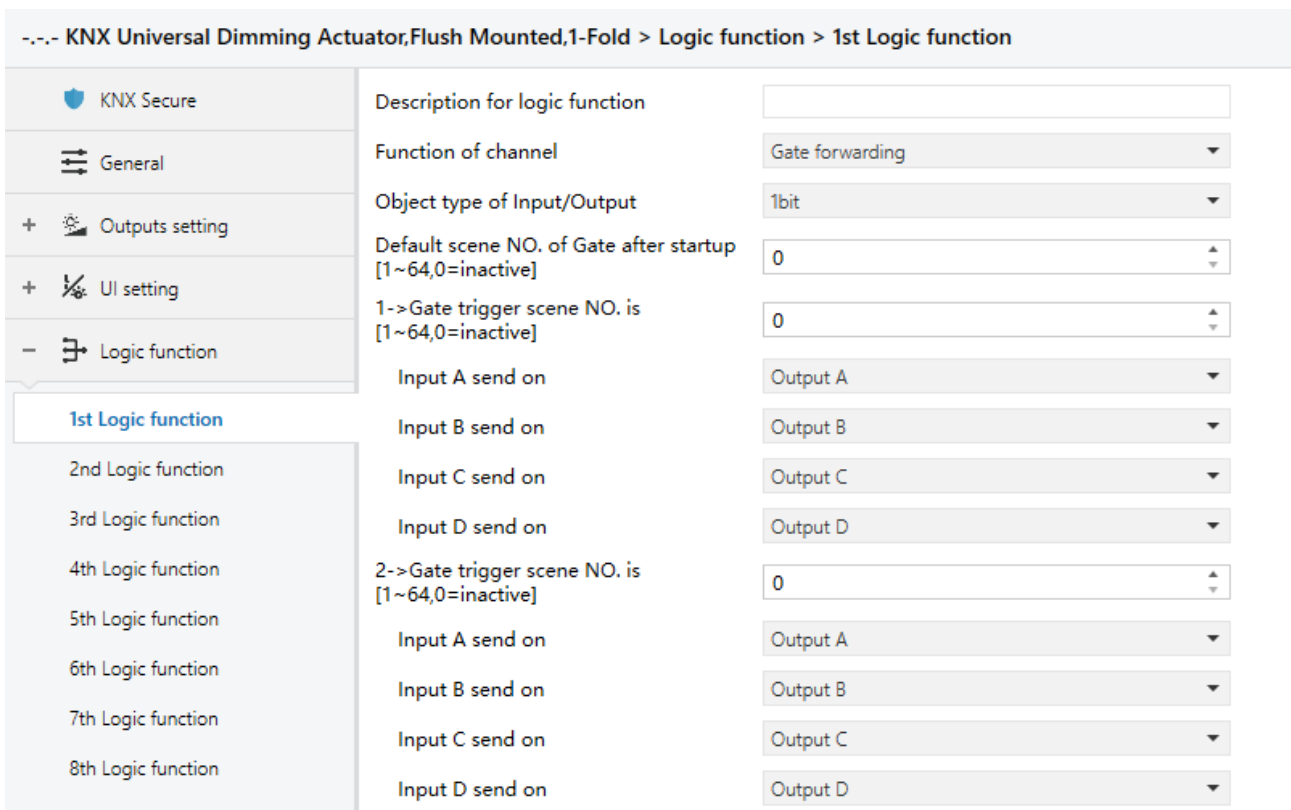

Fig.5.5.2 "Gate forwarding" parameter window

Parameter "Object type of Input/Output"

This parameter is for setting the object type of input/output. Options:

1bit

4bit

1byte

Parameter "Default scene NO. of Gate after startup [1~64,0=inactive]"

This parameter is for setting the initial scene where logical gate forwarding can be performed by default after device starts, which needs to be configured in the parameters. Options: **1..64, 0=inactive**

Note: gate scene is recommended to be selected before operating, or it will enable the initiate scene by default.

Parameter "z->Gate trigger scene NO. is [1~64,0=inactive]"(z=1~8)

This parameter is for setting scene number of logic gate forwarding. Up to 8 trigger scene number can be set for each logic. Options: **1..64, 0=inactive**

——Parameter "Input A/B/C/D send on"

This parameter is for setting the output of input X (X=A/B/C/D) after gate forwarding. Options:

Disable

Output A

Output B

...

Output B,C,D

According to the options, one input can be forwarded into one or more outputs, the output value is the same as the input value.

5.5.3. Parameter window "Threshold comparator"

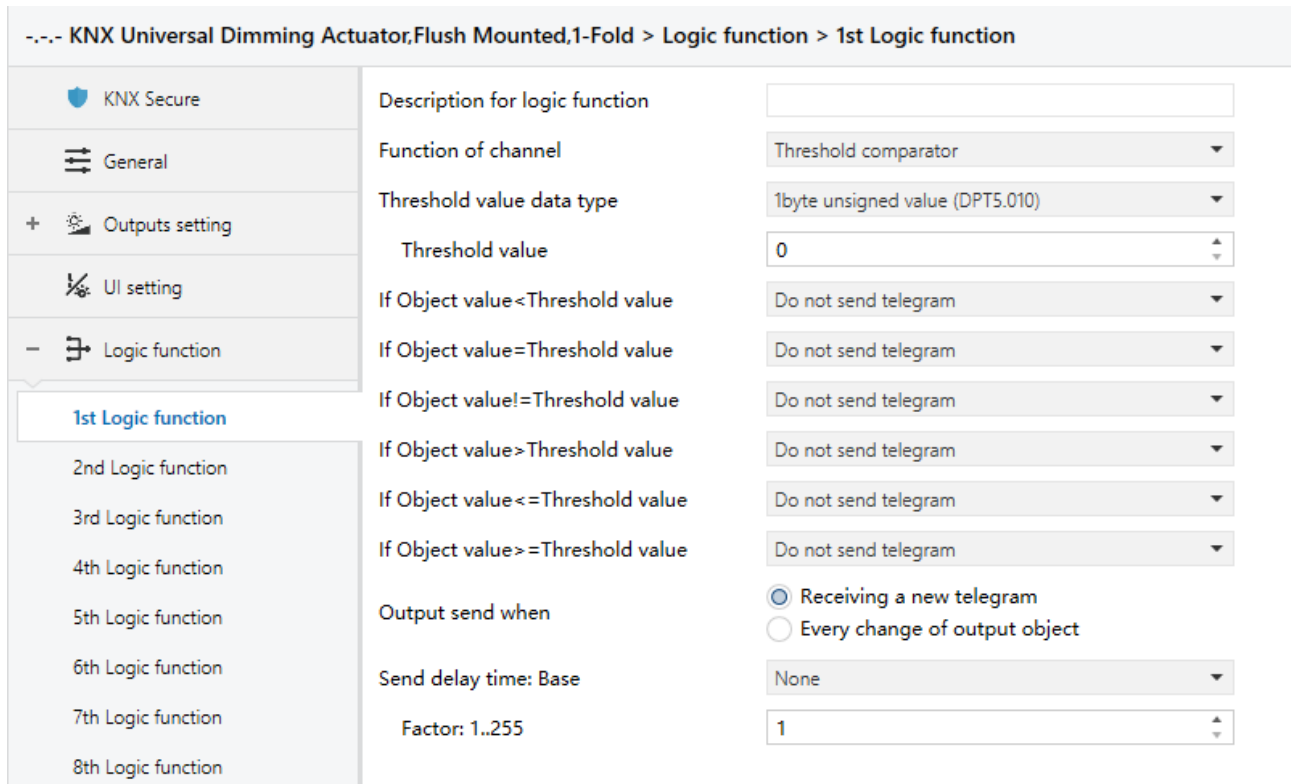

Fig.5.5.3 "Threshold comparator" parameter window

Parameter "Threshold value data type"

This parameter is for setting the threshold value data type. Options:

- | | |
|--|--|
| 4bit value (DPT3.007) | 4byte unsigned value[0..4294967295] |
| 1byte unsigned value (DPT5.010) | Ext. temperature value (DPT 9.001) |
| 2byte unsigned value (DPT7.001) | Ext. humidity value (DPT 9.007) |
| 2byte signed value (DPT8.x) | Illuminance value (DPT 9.004) |
| 2byte float value (DPT9.x) | |

Parameter "Threshold value "

This parameter is for setting threshold value, the range depends on the data type. Options:

- 4bit value (DPT3.007) 0..15 / 1byte unsigned value (DPT5.010) 0..255 /**
2byte unsigned value (DPT7.001) 0..65535 / 2byte signed value (DPT8.x) -32768..32767 /
2byte float value (DPT9.x) -670760...670760 / 4byte unsigned value[0..4294967295]
0..4294967295 / Ext. temperature value (DPT 9.001) -20..95°C / Ext. humidity value (DPT 9.007)
0..100% / Illuminance value (DPT 9.004) 0..65535lux

Parameter "Hysteresis threshold value"

This parameter is visible when object datatype is selected "2byte float value (DPT9.x)", "Illuminance value (DPT 9.004)". Set the hysteresis threshold value. Options: **0..500**

Parameter "If Object value<Threshold value"

Parameter "If Object value=Threshold value"

Parameter "If Object value!=Threshold value"

Parameter "If Object value>Threshold value"

Parameter "If Object value<=Threshold value"

Parameter "If Object value>=Threshold value"

This parameter is for setting the logic result value that should be sent when threshold value Less than, equal to, not equal to, greater than, less than or equal to the setting valve. When object datatype is selected "2byte float value (DPT9.x)", can only set the object value less than or greater than threshold value. Options:

Do not send telegram

Send value "0"

Send value "1"

Do not send telegram: not consider to select this option;

Send value "0"/"1": when condition is satisfied, send telegram 0 or1.

If there is a conflict between the setting options between parameters, the base on the value that should be sent when reach the final parameter condition. **For example: parameter "If Object value=Threshold value" is set to be "Send value "0" "; parameter "If Object value<=Threshold value" is set to be "Send value "1" "; when object value is equal to the threshold value, then the logic result will send "1".**

Parameter "Output send when"

This parameter is for setting the condition of sending logic result. Options:

Receiving a new telegram

Every change of output object

Receiving a new telegram: every time the object received a new input value will the logic result be sent to the bus;

Every change of output object: only when logic result has changed will it be sent to the bus.

Tip: when in the first time to logic algorithm, the logic result will be sent even if it has no change.

Parameter "Send delay time"

Base:	None
	0.1s
	1s
	...
	10s
	25s
Factor:	1..255

This parameter is for setting the delay time for sending the logic algorithm result to the bus. Delay time = Base x Factor, if option "None" of Base is selected, then there is no delay.

5.5.4.Parameter window "Format convert"

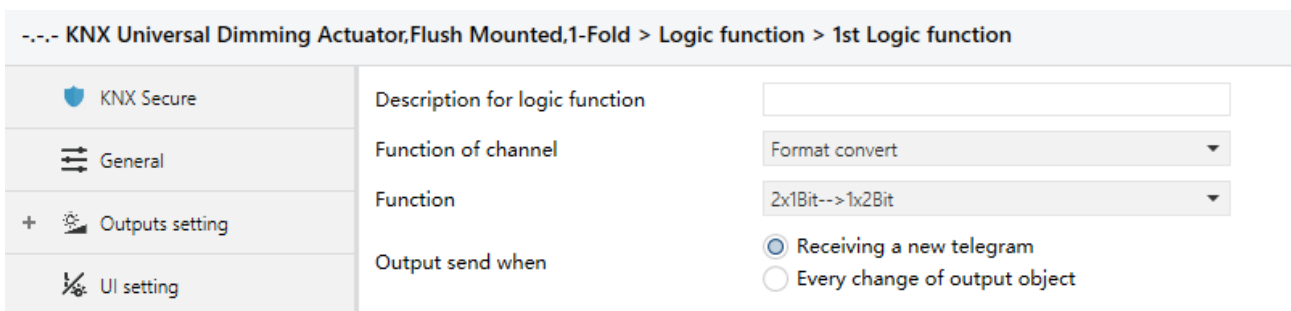

Fig.5.5.4 "Format convert" parameter window

Parameter "Function"

This parameter is for setting the format convert type. Options:

- 2x1bit-->1x2bit**
- 8x1bit-->1x1byte**
- 1x1byte-->1x2byte**
- 2x1byte-->1x2byte**
- 2x2byte-->1x4byte**
- 1x1byte-->8x1bit**
- 1x2byte-->2x1byte**

1x4byte-->2x2byte

1x3byte-->3x1byte

3x1byte-->1x3byte

Parameter "Output send when"

This parameter is for setting the condition of sending logic result. Options:

Receiving a new telegram

Every change of output object

Receiving a new telegram: every time the object received a new input value will the logic result be sent to the bus;

Every change of output object: only when logic result has changed will it be sent to the bus.

Tip: when in the first time to logic algorithm, the logic result will be sent even if it has no change.

5.5.5.Parameter window "Gate function"

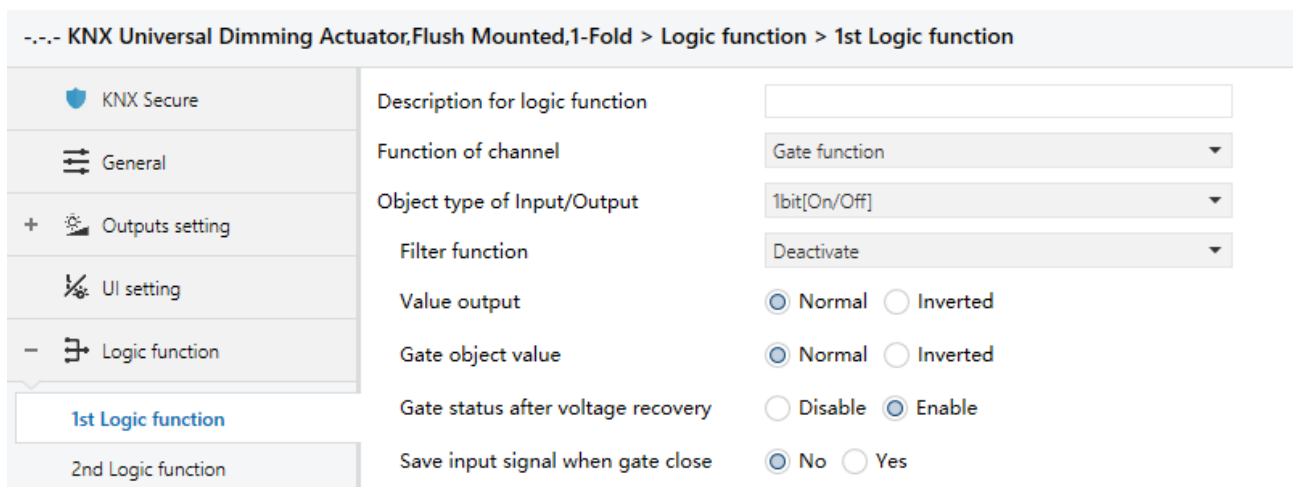

Fig.5.5.5 "Gate function" parameter window

Parameter "Object type of Input/Output"

This parameter is for setting the object type of input/output. Options:

1bit[On/Off]

1byte[0..100%]

1byte[0..255]

2byte[Float]

2byte[0..65535]

Parameter "Filter function"

This parameter is visible when "1bit[On/Off]" is selected. Set whether to filter On or Off telegram, only pass one of them or pass all. Options:

Deactivate

On filter out

Off filter out

Deactivate: Do not filter the On or Off telegrams;

On filter out: Off can pass, On cannot pass;

Off filter out: On can pass, Off cannot pass.

Parameter "Value output"

This parameter is visible when "1bit[On/Off]" is selected. Set whether to invert the value then output it. Options:

Normal

Inverted

Parameter "Gate object value"

This parameter is for setting whether to invert the gate object value then output it. Options:

Normal

Inverted

Parameter "Gate status after voltage recovery"

This parameter is for setting the gate status after power on. Options:

Disable

Enable

Parameter "Save input signal when gate close"

This parameter is for setting whether to save input signal on gate close. Options:

No

Yes

No: disable to save the input, the input values received during the gate closing period are ignored;

Yes: enable to save the input, the input values received during the gate closing period are output when gate is open (whether the input value is changed or not).

5.5.6. Parameter window "Delay function"

--- KNX Universal Dimming Actuator, Flush Mounted, 1-Fold > Logic function > 1st Logic function

<ul style="list-style-type: none"> KNX Secure General Outputs setting 	<p>Description for logic function <input type="text"/></p> <p>Function of channel <input type="text" value="Delay function"/></p> <p>Object type of Input/Output <input type="text" value="1bit[On/Off]"/></p> <p>Delay time [0..6500] <input type="text" value="10"/> s</p>
--	--

Fig.5.5.6 "Delay function" parameter window

Parameter "Object type of Input/Output"

This parameter is for setting the object type of input/output. Options:

1bit[On/Off]

1byte[0..100%]

1byte[0..255]

2byte[Float]

2byte[0..65535]

Parameter "Delay time [0..6500]"

This parameter is for setting the delay time that output object forwards the value when the input object receives the telegram. Options: **0..6500 s**

Note: Receive telegram again in delay time, re-timing.

5.5.7. Parameter window "Staircase lighting"

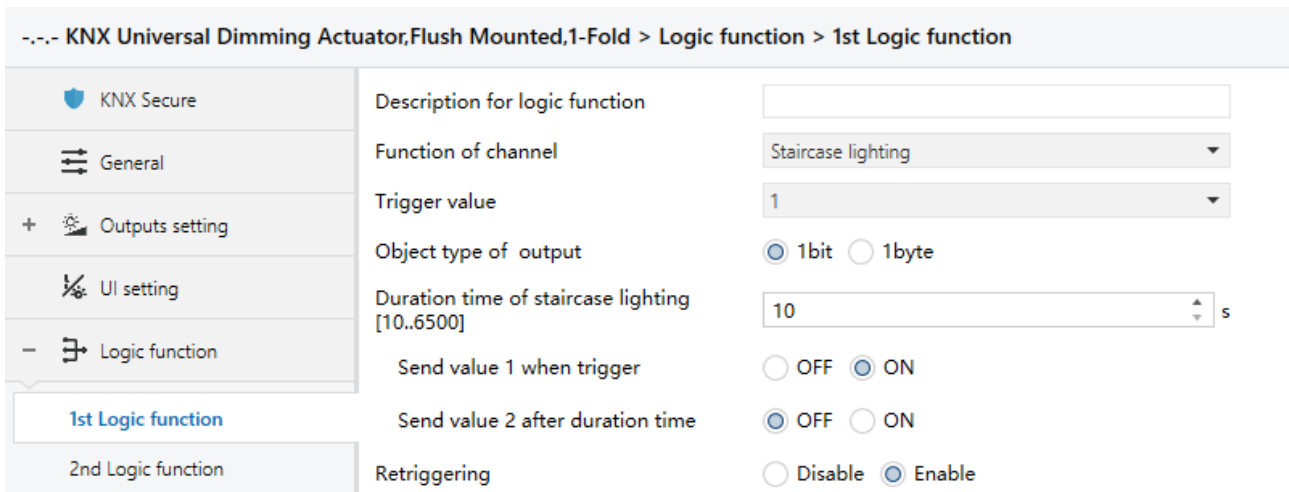

Fig.5.5.7 "Staircase lighting" parameter window

Parameter "Trigger value"

This parameter is for setting the telegram value of the object "Trigger value". Options:

0

1

0 or 1

Parameter "Object type of output"

This parameter is for setting the object type of output. Options:

1bit

1byte

Parameter "Duration time of staircase lighting[10..6500]"

This parameter is for setting duration time of staircase lighting after the stair light power on.

Options: **10..6500 s**

Parameter "Send value 1 when trigger"

Parameter "Send value 2 after duration time"

These parameters are for setting the value to send. Send value 1 when trigger, and then send value 2 after duration time. Options display according to the output object datatype.

When 1 bit, options:

OFF

ON

When 1 byte , options: **0..255**

Parameter "Retriggering"

This parameter is for setting whether to trigger re-timing when received trigger value in delay time.

Options:

Disable

Enable

Chapter 6 Description of Communication Object

The communication object is the medium to communicate other device on the bus, namely only the communication object can communicate with the bus.

NOTE: "C" in "Flag" column in the below table means enable the communication function of the object; "W" means value of object can be written from the bus; "R" means the value of the object can be read by the other devices; "T" means the object has the transmission function; "U" means the value of the object can be updated.

6.1."General" Communication Object

Number	Name	Object Function	Description	Group Address	Length	C	R	W	T	U	Data Type	Priority
1	General	In operation			1 bit	C	-	-	T	-	switch	Low
5	General	Central: Safety			1 bit	C	-	W	-	-	alarm	Low

Fig.6.1 "General" communication object

NO.	Object Function	Name	Data Type	Flag	DPT
1	In operation	General	1bit	C,R,T	1.001 switch
<p>The communication object is used to periodically send a telegram "1" to the bus to indicate that the device is working properly.</p>					
5	Central: Safety	General	1bit	C,W	1.005 alarm
<p>The communication object is used to receive the 1bit telegram that is sent from other device (such as sensor, controller, etc.), the cancel telegram value is decided by the parameter.</p> <p>If no corresponding telegram is received within the monitoring time, it is assumed that other devices are failure, and the channel with a safety function activates the safety operation. With a monitoring time of 0, it is also possible to activate and exit the safety operation by receiving the corresponding value with this object.</p> <p>In the case that the safety operation is not active, the cancel telegram is meaningless and it will be ignored.</p>					

Table 6.1 "General" communication object table

6.2."Output setting" Communication Object

	Number	Name	Object Function	Description	Group Address	Length	C	R	W	T	U	Data Type	Priority
■	78	Channel A-...	Switching			1 bit	C	-	W	-	-	switch	Low
■	79	Channel A-...	Relative dimming			4 bit	C	-	W	-	-	dimming control	Low
■	80	Channel A-...	Absolute dimming			1 byte	C	-	W	-	-	percentage (0..100%)	Low
■	81	Channel A-...	Switching, status			1 bit	C	R	-	T	-	switch	Low
■	82	Channel A-...	Brightness value, status			1 byte	C	R	-	T	-	percentage (0..100%)	Low
■	83	Channel A-...	Short-circuit, status			1 bit	C	R	-	T	-	alarm	Low
■	84	Channel A-...	Over-voltage, status			1 bit	C	R	-	T	-	alarm	Low
■	85	Channel A-...	Over-temperature, status			1 bit	C	R	-	T	-	alarm	Low
■	87	Channel A-...	Operation voltage failure			1 bit	C	R	-	T	-	alarm	Low
■	88	Channel A-...	Scene			1 byte	C	-	W	-	-	scene control	Low
■	89	Channel A-...	Staircase lighting			1 bit	C	-	W	-	-	start/stop	Low
■	90	Channel A-...	Duration of staircase lighting (5..65535s)			2 bytes	C	R	W	-	-	time (s)	Low
■	91	Channel A-...	Staircase lighting Prewarning			1 bit	C	R	-	T	-	alarm	Low
■	92	Channel A-...	Threshold input			1 byte	C	-	W	-	-	counter pulses (0..255)	Low
■	93	Channel A-...	Threshold value 1			1 byte	C	R	W	-	-	counter pulses (0..255)	Low
■	94	Channel A-...	Threshold value 2			1 byte	C	R	W	-	-	counter pulses (0..255)	Low
■	95	Channel A-...	Forced operation			2 bit	C	-	W	-	-	switch control	Low

Fig.6.2 "Output setting" communication object

NO.	Object Function	Name	Data Type	Flag	DPT
78	Switching	Channel A-{{...}}	1bit	C,W	1.001 switch
<p>The communication object is used to receive a command of switching on/off lamps. Telegrams:</p> <p style="padding-left: 40px;">1——Switch on</p> <p style="padding-left: 40px;">0——Switch off</p> <p>The name in parentheses changes with the parameter "Description (max 30char.)". If description is empty, display "Channel A - ..." by default. The same below.</p>					
79	Relative dimming	Channel A-{{...}}	4bit	C,W	3.007 dimming
<p>The communication object is used to receive a command of relative dimming, to dim up or dim down.</p> <p>Dimming down when telegram is 1~7, and the larger this range the adjust step is smaller. That is, the maximum step of dimming down when is 1, and the minimum step of dimming down when is 7, stop dimming when is 0;</p> <p>Dimming up when telegram is 9~15, and the larger this range the adjust step is smaller. That is, the maximum step of dimming up when is 9, and the minimum step of dimming up when is 15, stop dimming when is 8.</p>					
80	Absolute dimming	Channel A-{{...}}	1byte	C,W	5.001 percentage
<p>The communication object is used to receive a command of absolute dimming.</p> <p>Telegram: 0...100%</p>					
81	Switching, status	Channel A-{{...}}	1bit	C,R,T	1.001 switch
<p>The communication object is used to report the status of the current switch to the bus. Send "1" to</p>					

the bus when the value of the brightness is larger than 0, send "0" to the bus with value of "0". Send the status when voltage recovery.					
82	Brightness value, status	Channel A-{{...}}	1byte	C,R,T	5.001 percentage
The communication object is used to report the status of the current brightness value to the bus. Send the status at power-up when voltage recovery.					
83	Short-circuit, status	Channel A-{{...}}	1bit	C,R,T	1.005 alarm
The communication object is used to report the status of short circuit to the bus. Send the status at power-up when voltage recovery. Telegrams: 1—Short circuit 0—Normal					
84	Over-voltage, status	Channel A-{{...}}	1bit	C,R,T	1.005 alarm
The communication object is used to report the status of over-voltage to the bus. Send the status when voltage recovery. Telegrams: 1—Over voltage 0—Normal					
85	Over-temperature, status	Channel A-{{...}}	1bit	C,R,T	1.005 alarm
The communication object is used to report the status of over-temperature to the bus. Send the status when voltage recovery. Telegrams: 1—Over temperature 0—Normal					
87	Operation voltage failure	Channel A-{{...}}	1bit	C,R,T	1.005 alarm
The communication object is used to report the status of operation voltage failure to the bus. Operation voltage is failure when no valid over-zero signal is detected. Send the status when voltage recovery. Telegrams: 1—Operation voltage failure 0—Normal					
88	Scene	Channel A-{{...}}	1byte	C,W	18.001 scene control

The communication object is used to receive a 8 bit command to recall or storage scene. Detailed 8bit the meaning of the directive.

Set up a 8bit Orders for the (Binary code): FXNNNNNN

F: '0' recall scene; '1' for storage scene;

X : 0 ;

NNNNNN: Scene number(0... 63).

As follows:

Object message value	Description
0	Recall scene 1
1	Recall scene 2
2	Recall scene 3
...	...
63	Recall scene 64
128	Store scene 1
129	Store scene 2
130	Store scene 3
...	...
191	Store scene 64

Parameter setting Options are 1~64, actually communication object "Scene" corresponds to the telegram received is 0~63. Such as parameter settings is the scene 1, communication object "Scene" sends the scene for 0.

89	Delay switch	Channel A-{{...}}	1bit	C,W	1.001 switch
The communication object is visible when "Delay Switch" is selected for time function, used to turn on the function of delay switch.					
89	Flashing switch	Channel A-{{...}}	1bit	C,W	1.010 start/stop
The communication object is visible when "Flashing Switch" is selected for time function, used to turn on the function of flashing switch.					
89	Staircase lighting	Channel A-{{...}}	1bit	C,W	1.010 start/stop
The communication object is visible when "Staircase lighting" is selected for time function, used to turn on the function of staircase lighting.					
90	Duration of staircase lighting (5..65535s)	Channel A-{{...}}	2byte	C,W,R	7.005time(s)
The communication object is visible when "Staircase lighting" is selected for time function and duration time can be changed via bus. Used to modify the time, and save it after voltage failure. If the duration has not been modified, the value read from the object is the setting value of ETS parameter.					
91	Staircase lighting Prewarning	Channel A-{{...}}	1bit	C,R,T	1.005 alarm

<p>The communication object is visible when "Staircase lighting" is selected for time function and prewarn via bus. Used to send the telegram of prewarning before staircase lighting end. Telegram:</p> <p style="margin-left: 40px;">1——Warning</p> <p style="margin-left: 40px;">0——End of warning</p>					
92	Threshold input	Channel A-{{...}}	1byte 2byte	C,W	<p>5.010 counter pulses(0..255)</p> <p>5.001 percentage</p> <p>9.001 temperature</p> <p>9.004 brightness (lux)</p>
<p>The communication object is receive the input value of threshold function. Telegram value is determined by the datatype, and the datatype is determined by the parameter setting.</p>					
93	Threshold value 1	Channel A-{{...}}	1byte 2byte	C,W,R	<p>5.010 counter pulses(0..255)</p> <p>5.001 percentage</p> <p>9.001 temperature</p> <p>9.004 brightness (lux)</p>
94	Threshold value 2	Channel A-{{...}}	1byte 2byte	C,W,R	<p>5.010 counter pulses(0..255)</p> <p>5.001 percentage</p> <p>9.001 temperature</p> <p>9.004 brightness (lux)</p>
<p>These two communication objects are visible when the threshold value 1/2 can be changed via bus. Used to modify the values, and save them after voltage failure. If the thresholds have not been modified, the value read from the object is the setting value of ETS parameter. Note: threshold value 1 must be less than threshold value 2, or ignore the telegram.</p>					
95	Forced operation	Channel A-{{...}}	1bit 2bit	C,W	<p>1.003 enable</p> <p>2.001 DPT_Switch control</p>
<p>The communication object is used to trigger a forced operation. Save the trigger status when voltage failure, and keep the status at voltage recovery.</p> <p>When 1bit, activate the forced operation when receive telegram 1, at this time, ignore all the other actions; End the forced operation when receive telegram 0, and the behaviour in forced operation is defined by parameter.</p> <p>When 2bit, force to switch off when receive telegram 3; force to switch on when receive telegram 2; End the forced operation when receive telegram 1 or 0.</p> <p>The end telegram is invalid when the forced operation is not active, and ignore it directly.</p>					

Table 6.2 "Output setting" communication object table

6.3."UI setting" Communication Object

6.3.1."Input x" Communication Object

Number	Name	Object Function	Description	Group Address	Length	C	R	W	T	U	Data Type	Priority
190	Input 1-...	Switch			1 bit	C	-	W	T	U	switch	Low
190	Input 1-...	Press, Switch			1 bit	C	-	W	T	U	switch	Low
191	Input 1-...	Release, Switch			1 bit	C	-	W	T	U	switch	Low
190	Input 1-...	Short, Switch			1 bit	C	-	W	T	U	switch	Low
191	Input 1-...	Long, Switch			1 bit	C	-	W	T	U	switch	Low
194	Input 1-...	Disable			1 bit	C	-	W	-	-	enable	Low

Switch

Number	Name	Object Function	Description	Group Address	Length	C	R	W	T	U	Data Type	Priority
190	Input 1-...	Short, Switch			1 bit	C	-	W	T	U	switch	Low
191	Input 1-...	Long, Dimming			4 bit	C	-	W	T	-	dimming control	Low
194	Input 1-...	Disable			1 bit	C	-	W	-	-	enable	Low

Dimming

Number	Name	Object Function	Description	Group Address	Length	C	R	W	T	U	Data Type	Priority
190	Input 1-...	Press, 1bit value			1 bit	C	-	-	T	-	switch	Low
191	Input 1-...	Release, 2bit value			2 bit	C	-	-	T	-	switch control	Low

190	Input 1-...	Short, 1bit value			1 bit	C	-	-	T	-	switch	Low
191	Input 1-...	Long, 2bit value			2 bit	C	-	-	T	-	switch control	Low
194	Input 1-...	Disable			1 bit	C	-	W	-	-	enable	Low

Value output

Number	Name	Object Function	Description	Group Address	Length	C	R	W	T	U	Data Type	Priority
190	Input 1-...	Scene			1 byte	C	-	-	T	-	scene control	Low
194	Input 1-...	Disable			1 bit	C	-	W	-	-	enable	Low

190	Input 1-...	Press, Scene			1 byte	C	-	-	T	-	scene control	Low
191	Input 1-...	Release, Scene			1 byte	C	-	-	T	-	scene control	Low
190	Input 1-...	Short, Scene			1 byte	C	-	-	T	-	scene control	Low
191	Input 1-...	Long, Scene			1 byte	C	-	-	T	-	scene control	Low
194	Input 1-...	Disable			1 bit	C	-	W	-	-	enable	Low

Scene control

Number	Name	Object Function	Description	Group Address	Length	C	R	W	T	U	I	Data Type	Priority
190	Input 1-...	Up/Down, Blind			1 bit	C	-	W	T	-	-	up/down	Low
191	Input 1-...	Stop/Adjust, Blind			1 bit	C	-	W	T	-	-	step	Low
194	Input 1-...	Disable			1 bit	C	-	W	-	-	-	enable	Low

Blind

Number	Name	Object Function	Description	Group Address	Length	C	R	W	T	U	Data Type	Priority
190	Input 1-...	Register value			1 byte	C	-	W	T	-	counter pulses (0..255)	Low
194	Input 1-...	Disable			1 bit	C	-	W	-	-	enable	Low

Shift register

Number	Name	Object Function	Description	Group Address	Length	C	R	W	T	U	Data Type	Priority
190	Input 1-...	Object1-Up/Down			1 bit	C	-	W	T	-	up/down	Low
191	Input 1-...	Object2-Up/Down			1 bit	C	-	W	T	-	up/down	Low
192	Input 1-...	Object3-SceneControl			1 byte	C	-	-	T	-	scene control	Low
193	Input 1-...	Object4-Percentage			1 byte	C	-	-	T	-	percentage (0..100%)	Low
194	Input 1-...	Disable			1 bit	C	-	W	-	-	enable	Low

Multiple operation

Number	Name	Object Function	Description	Group Address	Length	C	R	W	T	U	Data Type	Priority
190	Input 1-...	Press, Delay mode			1 bit	C	-	-	T	-	switch	Low
190	Input 1-...	Short, Delay mode			1 bit	C	-	-	T	-	switch	Low
191	Input 1-...	Long, Delay mode			1 bit	C	-	-	T	-	switch	Low
194	Input 1-...	Disable			1 bit	C	-	W	-	-	enable	Low

Delay mode

Fig.6.3.1 "Input x" communication object

NO.	Object Function	Name	Data Type	Flag	DPT
190	Switch	Input 1-{{...}}	1bit	C,W, T,U	1.001 DPT_Switch
190	Press, Switch	Input 1-{{...}}	1bit	C,W, T,U	1.001 DPT_Switch
190	Short, Switch	Input 1-{{...}}	1bit	C,W, T,U	1.001 DPT_Switch
191	Release, Switch	Input 1-{{...}}	1bit	C,W, T,U	1.001 DPT_Switch
191	Long, Switch	Input 1-{{...}}	1bit	C,W, T,U	1.001 DPT_Switch

These communication objects are used to trigger a switching operation. Use a common object or two separate objects is according to the parameter setting when press/release and long/short operation.

Only the object "Switch" is visible when use a common object. If use two separate objects, "Press/Release" is visible when there is no distinction for short/long operation; "Short/Long" is visible when there is distinction for short/long operation. Telegrams:

0 — Off

1 — On

The name in parentheses changes with the parameter "Description (max 30char.)". If description is empty, display "Input 1 - ..." by default. The same below.

190	Short, Switch	Input 1-{{...}}	1bit	C,W, T,U	1.001 DPT_Switch
191	Long, Dimming	Input 1-{{...}}	4bit	C,W,T	3.007 DPT_Dimming control

These two communication objects are used to switch/dimming operation, with distinction for long/short operation.

Obj.190: Used to trigger switch operation. Telegrams:

0—Off

1—On

Obj.191: Used to trigger a relative dimming operation.

Dimming down when telegram is 1~7, and the larger this range the adjust step is smaller. That is, the maximum step of dimming down when is 1, and the minimum step of dimming down when is 7, stop dimming when is 0;

Dimming up when telegram is 9~15, and the larger this range the adjust step is smaller. That is, the maximum step of dimming up when is 9, and the minimum step of dimming up when is 15, stop dimming when is 8.

190	Press, 1bit/.../2byte value	Input 1-{{...}}	1bit	C,T	1.001 DPT_Switch
190	Short, 1bit/.../2byte value	Input 1-{{...}}	2bit	C,T	2.001 DPT_Switch control
191	Release, 1bit/.../2byte value	Input 1-{{...}}	4bit	C,T	3.007 DPT_Dimming control
191	Long, 1bit/.../2byte value	Input 1-{{...}}	1byte	C,T	5.010 DPT_counter pulses
			2byte	C,T	7.001 DPT_pulses

These two communication objects are used for sending a fixed value to the bus, "Press/Release" is visible when there is no distinction for short/long operation; "Short/Long" is visible when there is distinction for short/long operation. Range of values that can be sent are determined by the datatype, and the datatype is determined by the parameter setting.

190	Scene	Input 1-{{...}}	1byte	C,T	18.001 DPT_SceneControl
190	Press, Scene	Input 1-{{...}}	1byte	C,T	18.001 DPT_SceneControl
190	Short, Scene	Input 1-{{...}}	1byte	C,T	18.001 DPT_SceneControl
191	Release, Scene	Input 1-{{...}}	1byte	C,T	18.001 DPT_SceneControl
191	Long, Scene	Input 1-{{...}}	1byte	C,T	18.001 DPT_SceneControl

These communication objects are used to send a 8 bit command to recall or storage scene. Use a common object or two separate objects is according to the parameter setting when press/release and long/short operation.

Only the object "Scene" is visible when use a common object. If use two separate objects, "Press/Release" is visible when there is no distinction for short/long operation; "Short/Long" is visible when there is distinction for short/long operation.

Detailed 8bit the meaning of the directive.

Set up a 8bit Orders for the (Binary code): FXNNNNNN

F: '0' recall scene; '1' for storage scene;

X : 0 ;

NNNNNN: Scene number(0... 63).

As follows:

Object message value	Description
0	Recall scene 1
1	Recall scene 2
2	Recall scene 3
...	...
63	Recall scene 64
128	Store scene 1
129	Store scene 2
130	Store scene 3
...	...
191	Store scene 64

Parameter setting Options are 1~64, actually communication object "Scene" corresponds to the telegram received is 0~63. Such as parameter settings is the scene 1, communication object "Scene" sends the scene for 0.

190	Up/Down, Blind	Input 1-{{...}}	1bit	C,W,T	1.008 DPT_up/down
191	Stop/Adjust, Blind	Input 1-{{...}}	1bit	C,W,T	1.007 DPT_Step

These two communication objects are used to control the blind up,down, stop:

Obj.190: Used for sending the telegram to the bus, to control blind up/down. Telegrams:

1——Move down

0——Move up

Obj.191: Used for sending the telegram to the bus, to stop curtain movement. Telegrams:

1——Stop

190	Register value	Input 1-{{...}}	1bit	C,W,T	5.010 counter pulses 17.001 scene number 20.102 HVAC mode
-----	----------------	-----------------	------	-------	---

The communication object is used to send the value of shift register. Range of values that can be sent are determined by the datatype, and the datatype is determined by the parameter setting.

190/	Object x-On/Off	Input 1-{{...}}	1bit	C,W,T	1.001 DPT_Switch
------	-----------------	-----------------	------	-------	------------------

191/	Object x-Up/Down		1bit	C,W,T	1.008 DPT_up/down
192/	Object x-SceneControl		1byte	C,T	18.001 DPT_SceneControl
193/	Object x-Percentage		1byte	C,T	5.001 DPT_Scaling
	Object x-Unsigned value		1byte	C,T	5.010 DPT_counter pulses
<p>These communication objects are objects of multiple operation, up to activate 4 objects at the same time, and operate once can send 4 different values to the bus via these objects. Range of values that can be sent are determined by the datatype, and the datatype is determined by the parameter setting.</p>					
190	Press, Delay mode	Input 1-{{...}}	1bit	C,T	1.001 DPT_Switch
190	Short, Delay mode	Input 1-{{...}}	4bit	C,T	3.007 DPT_Dimming control
191	Long, Delay mode	Input 1-{{...}}	1byte	C,T	5.010 DPT_counter pulses
<p>These two communication objects are used to send the value of delay mode to the bus, "Press" is visible when there is no distinction for short/long operation; "Short/Long" is visible when there is distinction for short/long operation. Range of values that can be sent are determined by the datatype, and the datatype is determined by the parameter setting.</p>					
194	Disable	Input 1-{{...}}	1bit	C,W	1.003 DPT_enable
<p>The communication object is used to disable/enable the function of contact input, the telegram value is decided by the parameter.</p>					

Table 6.3.1 "Input x" communication object table

6.3.2."LED x" Communication Object

Number	Name	Object Function	Description	Group Address	Length	C	R	W	T	U	Data Type	Priority
234	LED 5-...	Status			1 bit	C	-	W	T	U	switch	Low

Fig.6.3.2 "LED x" communication object

NO.	Object Function	Name	Data Type	Flag	DPT
234	Status	LED 5-{{...}}	1bit	C,W,T,U	1.001 DPT_Switch
			1byte		5.010 DPT_counter pulses
<p>The communication object is used to receive the telegrams of 1bit/1byte, LED indicates according to the telegrams and parameter setting.</p> <p>The name in parentheses changes with the parameter "Description (max 30char.)". If description is empty, display "LED 5-..." by default.</p>					

Table 6.3.2 "LED x" communication object table

6.4."Logic" Communication Object

6.4.1."AND/OR/XOR" Communication Object

Number	Name	Object Function	Description	Group Address	Length	C	R	W	T	U	Data Type	Priority
6	1st Logic	Input a			1 bit	C	-	W	T	U	boolean	Low
7	1st Logic	Input b			1 bit	C	-	W	T	U	boolean	Low
8	1st Logic	Input c			1 bit	C	-	W	T	U	boolean	Low
9	1st Logic	Input d			1 bit	C	-	W	T	U	boolean	Low
10	1st Logic	Input e			1 bit	C	-	W	T	U	boolean	Low
11	1st Logic	Input f			1 bit	C	-	W	T	U	boolean	Low
12	1st Logic	Input g			1 bit	C	-	W	T	U	boolean	Low
13	1st Logic	Input h			1 bit	C	-	W	T	U	boolean	Low
14	1st Logic	Logic result			1 bit	C	-	-	T	-	boolean	Low

Fig.6.4.1 "AND/OR/XOR" communication object

NO.	Object Function	Name	Data Type	Flag	DPT
6/.../13	Input a/b/..h	{{1st Logic}}	1bit	C,W,T,U	1.002 boolean
<p>The communication object is used to receive the value of logical input Input a/b/..h.</p> <p>The name in parentheses changes with the parameter "Description for logic function". If description is empty, display "1st Logic" by default. The same below.</p>					
14	Logic result	{{1st Logic}}	1bit	C,T	1.002 boolean
<p>The communication object is used to send the results of logical operation.</p>					

Table 6.4.1 "AND/OR/XOR" communication object table

6.4.2."Gate forwarding" Communication Object

Number	Name	Object Function	Description	Group Address	Length	C	R	W	T	U	Data Type	Priority
6	1st Logic	Gate value select			1 byte	C	-	W	-	-	scene number	Low
7	1st Logic	Input A			1 bit	C	-	W	-	-	switch	Low
8	1st Logic	Input B			1 bit	C	-	W	-	-	switch	Low
9	1st Logic	Input C			1 bit	C	-	W	-	-	switch	Low
10	1st Logic	Input D			1 bit	C	-	W	-	-	switch	Low
11	1st Logic	Output A			1 bit	C	-	-	T	-	switch	Low
12	1st Logic	Output B			1 bit	C	-	-	T	-	switch	Low
13	1st Logic	Output C			1 bit	C	-	-	T	-	switch	Low
14	1st Logic	Output D			1 bit	C	-	-	T	-	switch	Low

Fig.6.4.2 "Gate forwarding" communication object

NO.	Object Function	Name	Data Type	Flag	DPT
6	Gate value select	{{1st Logic}}	1byte	C,W	17.001 scene number
The communication object is used to select the scene of logical gate forwarding.					
7/.../10	Input x	{{1st Logic}}	1bit 4bit 1byte	C,W	1.001 switch 3.007 dimming control 5.010 counter pulses(0..255)
The communication object is used to receive the value of the logic gate input Input x.					
11/.../14	Output x	{{1st Logic}}	1bit 4bit 1byte	C,T	1.001 switch 3.007 dimming control 5.010 counter pulses(0..255)
The communication object is used to output the value forwarded by the logic gate. The output value is the same as the input value, but one input can be forwarded into one or more outputs, set by parameters.					

Table 6.4.2 "Gate forwarding" communication object table

6.4.3. "Threshold comparator" Communication Object

Number	Name	Object Function	Description	Group Address	Length	C	R	W	T	U	Data Type	Priority
6	1st Logic	Threshold value input			4 bit	C	-	W	-	U	dimming control	Low
6	1st Logic	Threshold value input			1 byte	C	-	W	-	U	counter pulses (0..255)	Low
6	1st Logic	Threshold value input			2 bytes	C	-	W	-	U	pulses	Low
6	1st Logic	Threshold value input			2 bytes	C	-	W	-	U	2-byte signed value	Low
6	1st Logic	Threshold value input			2 bytes	C	-	W	-	U	2-byte float value	Low
6	1st Logic	Threshold value input			4 bytes	C	-	W	-	U	counter pulses (unsigned)	Low
6	1st Logic	Threshold value input			2 bytes	C	-	W	-	U	temperature (°C)	Low
6	1st Logic	Threshold value input			2 bytes	C	-	W	-	U	humidity (%)	Low
6	1st Logic	Threshold value input			2 bytes	C	-	W	-	U	lux (Lux)	Low
14	1st Logic	Logic result			1 bit	C	-	-	T	-	boolean	Low

Fig.6.4.3 "Threshold comparator" communication object

NO.	Object Function	Name	Data Type	Flag	DPT
6	Threshold value input	{{1st Logic}}	4bit	C,W, U	3.007 dimming
			1byte		5.010 counter pulses
			2byte		7.001 pulses
			4byte		12.001 counter pulses
The communication object is used to input threshold value.					
14	Logic result	{{1st Logic}}	1bit	C,T	1.002 boolean
The communication object is used to send the results of logical operation. That is, the value that should be sent after the object input threshold is compared with the setting threshold value.					

Table 6.4.3 "Threshold comparator" communication object table

6.4.4. "Format convert" Communication Object

Number	Name	Object Function	Description	Group Address	Length	C	R	W	T	U	Data Type	Priority
6	1st Logic	Input 1bit-bit0			1 bit	C	-	W	-	U	boolean	Low
7	1st Logic	Input 1bit-bit1			1 bit	C	-	W	-	U	boolean	Low
14	1st Logic	Output 2bit			2 bit	C	-	-	T	-	switch control	Low

"2x1bit --> 1x2bit"function: converts two 1bit values to a 2bit value, such as Input bit1=1, bit0=0--> Output 2bit=2

Number	Name	Object Function	Description	Group Address	Length	C	R	W	T	U	Data Type	Priority
6	1st Logic	Input 1bit-bit0			1 bit	C	-	W	-	U	boolean	Low
7	1st Logic	Input 1bit-bit1			1 bit	C	-	W	-	U	boolean	Low
8	1st Logic	Input 1bit-bit2			1 bit	C	-	W	-	U	boolean	Low
9	1st Logic	Input 1bit-bit3			1 bit	C	-	W	-	U	boolean	Low
10	1st Logic	Input 1bit-bit4			1 bit	C	-	W	-	U	boolean	Low
11	1st Logic	Input 1bit-bit5			1 bit	C	-	W	-	U	boolean	Low
12	1st Logic	Input 1bit-bit6			1 bit	C	-	W	-	U	boolean	Low
13	1st Logic	Input 1bit-bit7			1 bit	C	-	W	-	U	boolean	Low
14	1st Logic	Output 1byte			1 byte	C	-	-	T	-	counter pulses (0..255)	Low

"8x1bit --> 1x1byte"function: converts eight 1bit values to a 1byte value, such as Input bit2=1, bit1=1, bit0=1, other bits are 0--> Output 1byte=7

Number	Name	Object Function	Description	Group Address	Length	C	R	W	T	U	Data Type	Priority
6	1st Logic	Input 1byte			1 byte	C	-	W	-	U	counter pulses (0..255)	Low
14	1st Logic	Output 2byte			2 bytes	C	-	-	T	-	pulses	Low

"1x1byte --> 1x2byte"function: converts one 1byte values to a 2byte value, such as Input 1byte=125--> Output 2byte=125. Although the value remains the same, the data type of the value is different.

Number	Name	Object Function	Description	Group Address	Length	C	R	W	T	U	Data Type	Priority
6	1st Logic	Input 1byte-low			1 byte	C	-	W	-	U	counter pulses (0..255)	Low
7	1st Logic	Input 1byte-high			1 byte	C	-	W	-	U	counter pulses (0..255)	Low
14	1st Logic	Output 2byte			2 bytes	C	-	-	T	-	pulses	Low

"2x1byte --> 1x2byte"function: converts two 1byte values to a 2byte value, such as Input 1byte-low = 255 (\$FF), Input 1byte-high = 100 (\$64) --> Output 2byte = 25855 (\$64 FF)

Number	Name	Object Function	Description	Group Address	Length	C	R	W	T	U	Data Type	Priority
6	1st Logic	Input 2byte-low			2 bytes	C	-	W	-	U	pulses	Low
7	1st Logic	Input 2byte-high			2 bytes	C	-	W	-	U	pulses	Low
14	1st Logic	Output 4byte			4 bytes	C	-	-	T	-	counter pulses (unsigned)	Low

"2x2byte --> 1x4byte"function: converts two 2 byte values to a 4byte value, such as Input 2byte-low = 65530 (\$FF FA), Input 2byte-high = 32768 (\$80 00)--> Output 2byte = 2147549178 (\$80 00 FF FA)

Number	Name	Object Function	Description	Group Address	Length	C	R	W	T	U	Data Type	Priority
6	1st Logic	Input 1byte			1 byte	C	-	W	-	U	counter pulses (0..255)	Low
7	1st Logic	Output 1bit-bit0			1 bit	C	-	-	T	-	boolean	Low
8	1st Logic	Output 1bit-bit1			1 bit	C	-	-	T	-	boolean	Low
9	1st Logic	Output 1bit-bit2			1 bit	C	-	-	T	-	boolean	Low
10	1st Logic	Output 1bit-bit3			1 bit	C	-	-	T	-	boolean	Low
11	1st Logic	Output 1bit-bit4			1 bit	C	-	-	T	-	boolean	Low
12	1st Logic	Output 1bit-bit5			1 bit	C	-	-	T	-	boolean	Low
13	1st Logic	Output 1bit-bit6			1 bit	C	-	-	T	-	boolean	Low
14	1st Logic	Output 1bit-bit7			1 bit	C	-	-	T	-	boolean	Low

"1x1byte --> 8x1bit" function: converts one 1byte values to eight 1but value, such as Input 1byte=200 --> Output bit0=0, bit1=0, bit2=0, bit3=1, bit4=0, bit5=0, bit6=1, bit7=1

Number	Name	Object Function	Description	Group Address	Length	C	R	W	T	U	Data Type	Priority
6	1st Logic	Input 2byte			2 bytes	C	-	W	-	U	pulses	Low
13	1st Logic	Output 1byte-low			1 byte	C	-	-	T	-	counter pulses (0..255)	Low
14	1st Logic	Output 1byte-high			1 byte	C	-	-	T	-	counter pulses (0..255)	Low

"1x2byte --> 2x1byte"function: converts one 2byte values to two 2byte value, such as Input 2byte = 55500

(\$D8 CC) --> Output 1byte-low = 204 (\$CC), Output 1byte-high =216 (\$D8)

Number	Name	Object Function	Description	Group Address	Length	C	R	W	T	U	Data Type	Priority
6	1st Logic	Input 4byte			4 bytes	C	-	W	-	U	counter pulses (unsigned)	Low
13	1st Logic	Output 2byte-low			2 bytes	C	-	-	T	-	pulses	Low
14	1st Logic	Output 2byte-high			2 bytes	C	-	-	T	-	pulses	Low

"1x4byte --> 2x2byte"function: converts one 4byte values to two 2byte value, such as Input 4byte = 78009500 (\$04 A6 54 9C) --> Output 2byte-low = 21660 (\$54 9C), Output 2byte-high =1190 (\$04 A6)

Number	Name	Object Function	Description	Group Address	Length	C	R	W	T	U	Data Type	Priority
6	1st Logic	Input 3byte			3 bytes	C	-	W	-	U	RGB value 3x(0..255)	Low
12	1st Logic	Output 1byte-low			1 byte	C	-	-	T	-	counter pulses (0..255)	Low
13	1st Logic	Output 1byte-middle			1 byte	C	-	-	T	-	counter pulses (0..255)	Low
14	1st Logic	Output 1byte-high			1 byte	C	-	-	T	-	counter pulses (0..255)	Low

"1x3byte --> 3x1byte"function: converts one 3byte values to three 1byte value, such as Input 3byte = \$78 64 C8--> Output 1byte-low = 200 (\$C8) , Output 1byte-middle = 100 (\$64) , Output 1byte-high =120 (\$78)

Number	Name	Object Function	Description	Group Address	Length	C	R	W	T	U	Data Type	Priority
6	1st Logic	Input 1byte-low			1 byte	C	-	W	-	U	counter pulses (0..255)	Low
7	1st Logic	Input 1byte-middle			1 byte	C	-	W	-	U	counter pulses (0..255)	Low
8	1st Logic	Input 1byte-high			1 byte	C	-	W	-	U	counter pulses (0..255)	Low
14	1st Logic	Output 3byte			3 bytes	C	-	-	T	-	RGB value 3x(0..255)	Low

"3x1byte --> 1x3byte"function: converts three 1byte values to a 3byte value, such as Input 1byte-low = 150 (\$96), Input 1byte-middle = 100 (\$64), Input 1byte-high = 50 (\$32)--> Output 3byte = \$32 64 96

Fig.6.4.4 "Format convert" communication object

NO.	Object Function	Name	Data Type	Flag	DPT
6	Input ...	{{1st Logic}}	1bit	C,W,U	1.001 switch
			1byte		5.010 counter pulses(0..255)
			2byte		7.001 pulses
			3byte		232.600 RGB value 3x(0..255)
			4byte		12.001 counter pulses
The communication object is used to input a value that needs to be converted.					
14	Output ...	{{1st Logic}}	1bit	C,T	1.001 switch
			2bit		2.001 switch control
			1byte		5.010 counter pulses(0..255)
			2byte		7.001 pulses
			3byte		232.600 RGB value 3x(0..255)
4byte	12.001 counter pulses				
The communication object is used to output the converted value.					

Table 6.4.4 "Format convert" communication object table

6.4.5."Gate function" Communication Object

Number	Name	Object Function	Description	Group Address	Length	C	R	W	T	U	Data Type	Priority
6	1st Logic	Input			1 bit	C	-	W	-	-	switch	Low
7	1st Logic	Gate input			1 bit	C	-	W	-	-	boolean	Low
14	1st Logic	Output			1 bit	C	-	-	T	-	switch	Low
Input/Output - 1bit[On/Off]												
6	1st Logic	Input			1 byte	C	-	W	-	-	percentage (0..100%)	Low
7	1st Logic	Gate input			1 bit	C	-	W	-	-	boolean	Low
14	1st Logic	Output			1 byte	C	-	-	T	-	percentage (0..100%)	Low
Input/Output - 1byte[0..100%]												
6	1st Logic	Input			1 byte	C	-	W	-	-	counter pulses (0..255)	Low
7	1st Logic	Gate input			1 bit	C	-	W	-	-	boolean	Low
14	1st Logic	Output			1 byte	C	-	-	T	-	counter pulses (0..255)	Low
Input/Output - 1byte[0..255]												
6	1st Logic	Input			2 bytes	C	-	W	-	-	temperature (°C)	Low
7	1st Logic	Gate input			1 bit	C	-	W	-	-	boolean	Low
14	1st Logic	Output			2 bytes	C	-	-	T	-	temperature (°C)	Low
Input/Output - 2byte[Float]												
6	1st Logic	Input			2 bytes	C	-	W	-	-	pulses	Low
7	1st Logic	Gate input			1 bit	C	-	W	-	-	boolean	Low
14	1st Logic	Output			2 bytes	C	-	-	T	-	pulses	Low
Input/Output - 2byte[0..65535]												

Fig.6.4.5 "Gate function" communication object

NO.	Object Function	Name	Data Type	Flag	DPT
6	Input	{{1st Logic}}	1bit	C,W	1.001 switch
			1byte		5.001 percentage
			2byte		5.010 counter pulses
					9.001 temperature
					7.001 pulses
The communication object is used to input a value that needs to gate filter.					
7	Gate input	{{1st Logic}}	1bit	C,W	1.002 boolean
The communication object is used to control the switch status of gate input. Input signal is allowed to pass when gate open, then output, and the current input status is still sent if there is a change; Can not pass when gate close.					
14	Output	{{1st Logic}}	bit	C,T	1.001 switch
			1byte		5.001 percentage
			2byte		5.010 counter pulses
					9.001 temperature
					7.001 pulses
The communication object is used to output the value after gate filtering. Only when gate input status is open, output is available, defined by the object "Gate input".					

Table 6.4.5 "Gate function" communication object table

6.4.6."Delay function" Communication Object

Number	Name	Object Function	Description	Group Address	Length	C	R	W	T	U	Data Type	Priority
6	1st Logic	Input			1 bit	C	-	W	-	-	switch	Low
14	1st Logic	Output			1 bit	C	-	-	T	-	switch	Low
1bit[On/Off]												
6	1st Logic	Input			1 byte	C	-	W	-	-	percentage (0..100%)	Low
14	1st Logic	Output			1 byte	C	-	-	T	-	percentage (0..100%)	Low
1byte[0..100%]												
6	1st Logic	Input			1 byte	C	-	W	-	-	counter pulses (0..255)	Low
14	1st Logic	Output			1 byte	C	-	-	T	-	counter pulses (0..255)	Low
1byte[0..255]												
6	1st Logic	Input			2 bytes	C	-	W	-	-	temperature (°C)	Low
14	1st Logic	Output			2 bytes	C	-	-	T	-	temperature (°C)	Low
2byte[Float]												
6	1st Logic	Input			2 bytes	C	-	W	-	-	pulses	Low
14	1st Logic	Output			2 bytes	C	-	-	T	-	pulses	Low
2byte[0..65535]												

Fig.6.4.6 "Delay function" communication object

NO.	Object Function	Name	Data Type	Flag	DPT
6	Input	{{1st Logic}}	1bit 1byte 2byte	C,W	1.001 switch 5.001 percentage 5.010 counter pulses 9.001 temperature 7.001 pulses
The communication object is used to input a value that needs to delay.					
14	Output	{{1st Logic}}	1bit 1byte 2byte	C,T	1.001 switch 5.001 percentage 5.010 counter pulses 9.001 temperature 7.001 pulses
The communication object is used to output that needs to delay converted value, delay time is defined by the parameter.					

Table 6.4.6 "Delay function" communication object table

6.4.7. "Staircase lighting" Communication Object

Number	Name	Object Function	Description	Group Address	Length	C	R	W	T	U	Data Type	Priority
6	1st Logic	Trigger value			1 bit	C	-	W	-	-	trigger	Low
7	1st Logic	Light-on duration time			2 bytes	C	-	W	-	-	time (s)	Low
14	1st Logic	Output			1 bit	C	-	-	T	-	switch	Low
14	1st Logic	Output			1 byte	C	-	-	T	-	counter pulses (0..255)	Low

Fig.6.4.7 "Staircase lighting" communication object

NO.	Object Function	Name	Data Type	Flag	DPT
6	Trigger value	{{1st Logic}}	1bit	C,W	1.017 trigger
The communication object is used to receive the value to trigger staircase lighting.					
7	Light-on duration time	{{1st Logic}}	2byte	C,W	7.005 time(s)
The communication object is used to modify the staircase light-on duration time, the modified range is referenced from the range defined by the parameter, take the limit value if exceeded.					
14	Output	{{1st Logic}}	1bit 1byte	C,T	1.001 switch 5.010 counter pulses
The communication object is used to output value 1 when trigger, and send value 2 after duration time. Telegram value is determined by the parameter setting datatype.					

Table 6.4.7 "Staircase lighting" communication object table