

使用手册

K-BUS® KNX 智能屏 S15

KNX Smart Touch S15_V1.0

CHTI-15.6/240.1.2x



KNX/EIB 住宅和楼宇智能控制系统

S15 系列包含 KNX 智能屏 S15 曜夜黑、流光银与静谧灰。

产品	型号
KNX 智能屏 S15	CHTI-15.6/240.1.21(曜夜黑)
	CHTI-15.6/240.1.22(流光银)
	CHTI-15.6/240.1.23(静谧灰)

目录

第一章 概要	1
第二章 技术参数	2
第三章 尺寸图和接线图	3
3.1 尺寸图	3
3.1.1 KNX 智能屏 S15	3
3.2 接线图	4
3.2.1 KNX 智能屏 S15	4
3.3 安装和拆卸说明	5
3.3.1 KNX 智能屏 S15 安装和拆卸说明	5
第四章 项目设计和应用	9
第五章 ETS 系统参数设置说明	13
5.1 KNX 安全	13
5.2 参数设置界面 “General”	18
5.2.1 参数设置界面 “General setting”	18
5.2.2 参数设置界面 “Security setting”	23
5.2.3 参数设置界面 “Night mode setting”	25
5.2.4 参数设置界面 “Coordinates location setting”	29
5.2.5 参数设置界面 “Summer time setting”	31
5.2.6 参数设置界面 “Proximity setting”	33
5.2.7 参数设置界面 “Advanced setting”	35
5.3 参数设置界面 “HVAC controller”	36
5.3.1 参数设置界面 “Cotroller x-Room temperature controller(RTC)”(x=1~6)	36
5.3.1.1 设置参数界面 “Setpoint”	45

5.3.1.2 设置参数界面 “Heating control/Cooling control/Heating/Cooling control”	52
5.3.1.3 设置参数界面 “Fan auto.control”	65
5.3.2 参数设置界面 “Cotroller x-Ventilation controller”(x=1~6)	71
5.4 参数设置界面 “Human Centric Lighting(HCL)”	78
5.5 参数设置界面 “Schedule function”	83
5.5.1 参数设置界面 “Schedule X”	83
5.6 参数设置界面 “Alarm function”	86
5.6.1 设置参数界面 “Alarm x”(x=1~24)	88
5.7 参数设置界面 “Logic function”	89
5.7.1 “AND/OR/XOR”功能参数	92
5.7.2 “Gate forwarding”功能参数	95
5.7.3 “Threshold comparator”功能参数	97
5.7.4 “Format convert”功能参数	100
5.7.5 “Gate function”功能参数	101
5.7.6 “Delay function”功能参数	103
5.7.7 “Staircase lighting”	104
5.8 参数设置界面 “Scene group function”	106
5.9 设置参数界面 “Home page”	110
5.10 设置参数界面 “Display view”	112
5.11 设置参数界面 “KNX Channel”	114
5.11.1 设置参数界面 “Channel X”(X=1~240)	117
5.11.2 基本功能参数	120
5.11.2.1.开关功能	120
5.11.2.2.按下/松开开关功能	122
5.11.2.3.相对调光、亮度调节、相对&亮度调节	123
5.11.2.4.色温调节功能	125

5.11.2.5.RGB/RGBW/RGBCW	127
5.11.2.6.窗帘功能	132
5.11.2.7.空调控制功能	135
5.11.2.8.温控功能	139
5.11.2.9.新风功能	149
5.11.2.10.背景音乐功能	155
5.11.2.11.能源检测功能	160
5.11.2.12.温度/湿度传感器功能	163
5.11.2.13.环境状态传感器检测功能	165
5.11.2.14.I/O 传感器功能	173
5.11.2.15.值发送功能	174
5.12 设置参数界面 “KNX Scene”	176
5.13 设置参数界面 “Internal sensor measurement”	178
第六章 通讯对象说明	183
6.1 “General”通用通讯对象	183
6.2 “Internal sensor”通讯对象	184
6.3 “Logic”通讯对象	185
6.3.1 “AND/OR/XOR”的通讯对象	185
6.3.2 “Gate forwarding”的通讯对象	186
6.3.3 “Threshold comparator”的通讯对象	187
6.3.4 “Format convert”通讯对象	188
6.3.5 “Gate function”通讯对象	191
6.3.6 “Delay function”通讯对象	192
6.3.7 “Staircase lighting”通讯对象	193
6.4 “Scene Group setting”通讯对象	195
6.5 “HVAC controller”通讯对象	197
6.5.1 “Room temperature controller (RTC) ”通讯对象	197

6.5.2 "Ventilation controller"通讯对象	205
6.6 "Human Centric Lighting(HCL)"通讯对象	206
6.7 "Schedule function"通讯对象	210
6.8 "Alarm function"通讯对象	211
10.1 "KNX Channel general"通讯对象	212
6.10 "KNX Channel X"通讯对象	213
6.10.1 "Switch"通讯对象	214
6.10.2 "Dimming"通讯对象	215
6.10.3 "Colour and colour temperature control"通讯对象	216
6.10.4 "Blind"通讯对象	224
6.10.5 "Air conditioner"通讯对象	229
6.10.6 "Room temperature unit control"通讯对象	232
6.10.7 "Ventilation system"通讯对象	238
6.10.8 "Audio control"通讯对象	242
6.10.9 "Energy Metering display"参数对象	249
6.10.10 "Sensor"通讯对象	251
6.10.11 "Value sender"通讯对象	256
6.11 "KNX Scene"通讯对象	258
6.12 "Input x"通讯对象	259
6.13 "Extension function"通讯对象	264

第一章 概要

KNX 智能屏 S15 是一款 15.6 寸 KNX 智能控制屏，屏幕分辨率可达 1920*1080。在集成 KNX 设备控制的同时，还接入了 SIP 对讲系统，将户内户外联合成了一个整体。

在智能控制上集成开关、调光、窗帘、值发送、色温、颜色控制(RGB、RGBW、RGBCW)、背景音乐、温控功能、空调控制、新风系统控制等。不仅支持空气质量传感器检测值显示，能源检测值显示功能，及设备状态显示，还支持靠近感应、光照度检测、温湿度检测等多种传感器，满足大部分的日常应用。另外，它还可以支持定时功能、逻辑功能、场景组功能，让您的生活更智能。作为对讲室内机设备，支持有线网络接入，并支持地址簿导入、通讯录管理，SIP 可视对讲通话、语音留言、安防监控、虚拟防区管理等常用功能，还可以支持屏保、锁屏、密码访问、定时、逻辑功能、场景组功能等多种功能。

KNX 智能屏 S15 不仅需要 KNX 总线供电，还需要一个 12-30V DC 的辅助电源供电，或者使用 POE 供电。物理地址的分配及参数的设定都可以使用带有.knxprod 文件的工程设计工具软件 ETS（版本 ETS5.7 或以上）。

第二章 技术参数

总线电源	总线电压	21-30V DC, 由 KNX 总线提供
	总线电流	<3.8mA/24V, <3.4mA/30V
	总线功耗	<0.1W
辅助电源	电压	22-30V DC
	电流	<500mA/24V, <400mA/30V
	功耗	<12W
连 接	KNX	总线连接端子(红/黑)
	辅助电源	2P 端子(红黑线)
	RJ45 (LAN)	用于接入可视对讲系统, 支持 POE
	RJ45 (WAN)	用于连接互联网
操作和指示	编程按键和编程指示灯	分配物理地址
靠近感应距离	普通感应: 30cm	增强感应: 60cm
温度传感器	-40°C-80°C	
湿度传感器	0-100%	
温度范围	运行	- 5 °C ... + 45 °C
	存储	-25 °C ... + 55 °C
	运输	- 25 °C ... + 70 °C
环境条件	湿度	<95%, 结露除外
安装	标准 86 盒或双 60 盒墙装方式	
尺寸	KNX 智能屏 S15: 248mm*154.6mm*34.4mm	

第三章 尺寸图和接线图

3.1 尺寸图

3.1.1 KNX 智能屏 S15



图 3.1.1(1) KNX 智能屏 S15

3.2 接线图

3.2.1 KNX 智能屏 S15

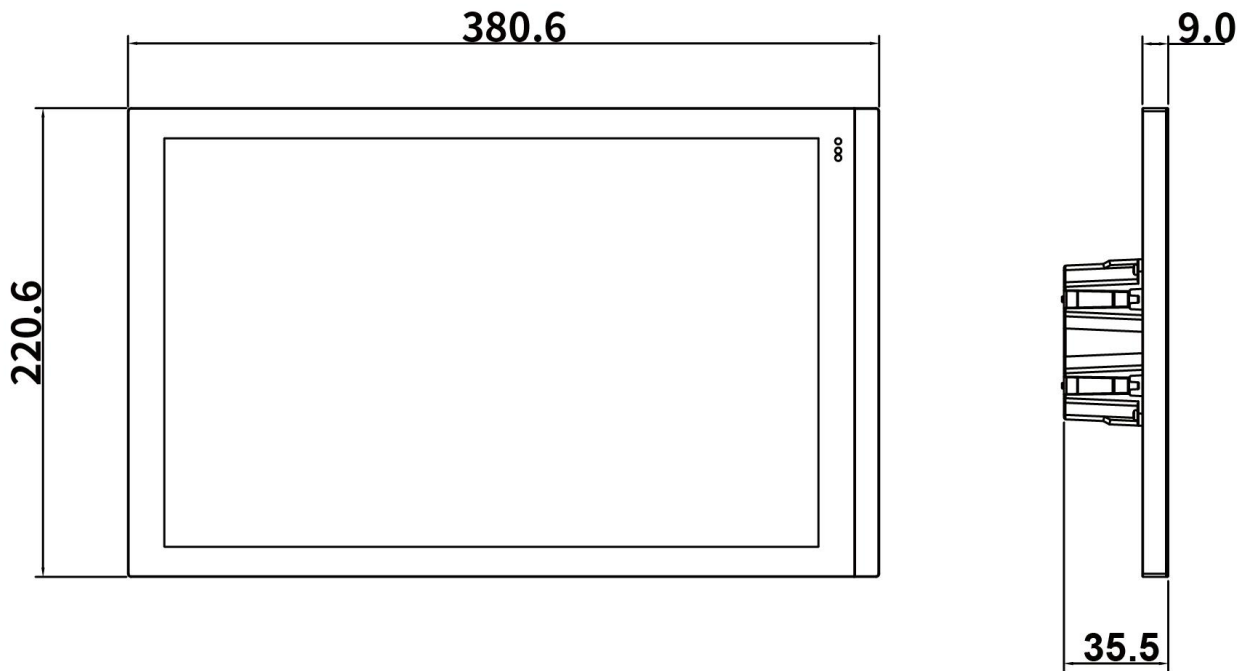

图 3.2.1 KNX 智能屏 S15

- | | |
|----------|-------------|
| ①触屏与显示区域 | ⑥复位按键 |
| ②光感和靠近感应 | ⑦防区接口 |
| ③温度传感器 | ⑧辅助供电连接端子 |
| ④喇叭*2 | ⑨KNX 总线连接端子 |
| ⑤麦克风*4 | ⑩以太网网口 |
| | ⑪Type-C |

3.3 安装和拆卸说明

3.3.1 KNX 智能屏 S15 安装和拆卸说明

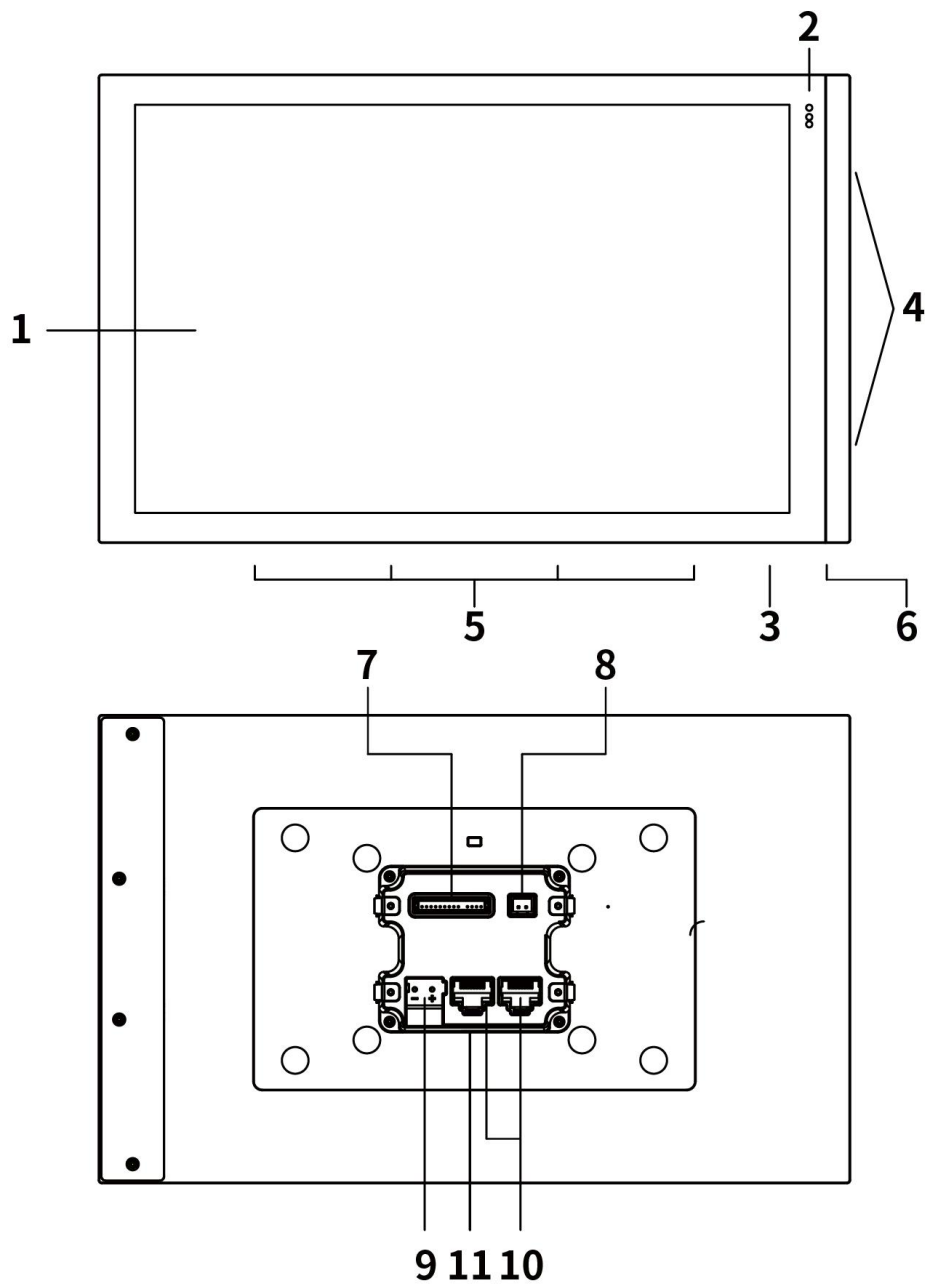
安装说明

1. 将挂板通过安装螺丝安装到墙上预埋盒。

安装规范：

(1) 设备安装适配,单 86 盒与双 60 盒, 如图 1 所示;



图1

(2) 先取出挂架及挂架固定螺丝, 用螺丝将挂架固定在预埋盒上。如图 2 所示;



(3) 安装时螺丝刀力度不能过大，导致挂板变形。建议的力度为 0.6~0.8N.M (6~8Kgf.cm)。

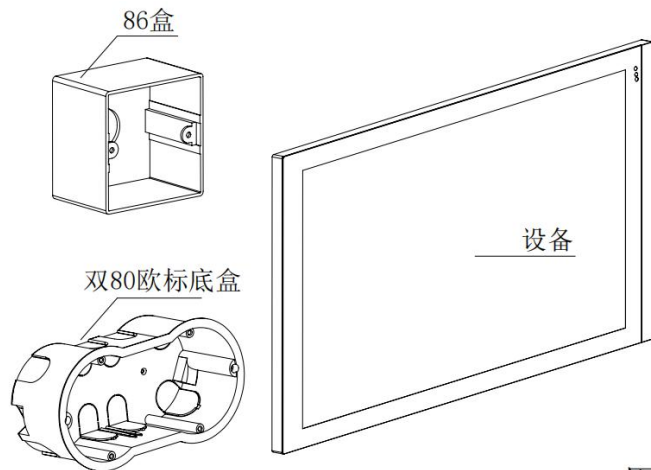
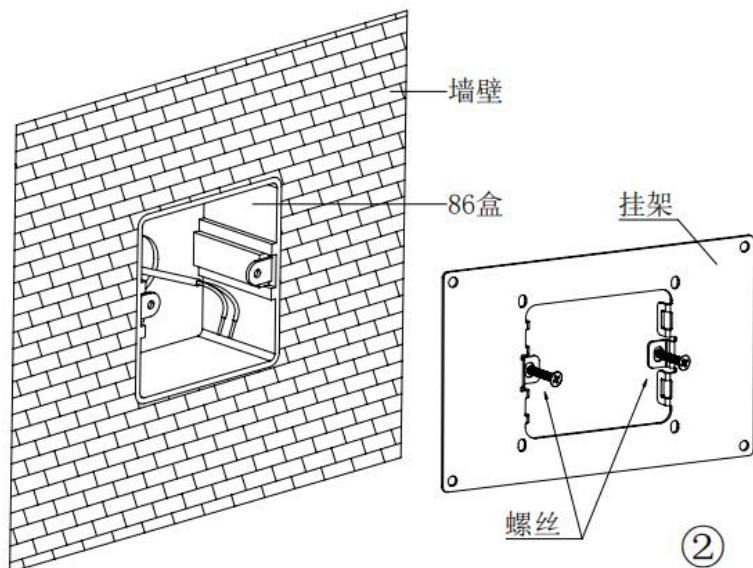
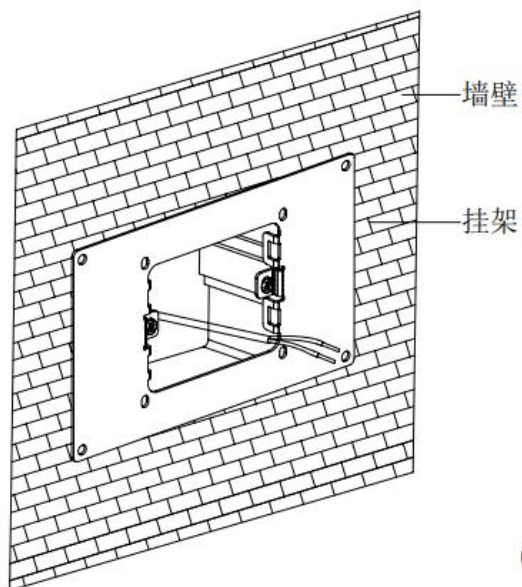

(4) 将接好线的 EIB 端子插入设备并将网线与设备连接好。

2. 将面板上的 KNX 总线连接端子取下，按接线说明进行接线。如图 3 所示；完成接线后，再把接好线的 KNX 总线端子插入设备，并将网线以及干接点，电源端子与设备连接好，即可完成接线安装。如图 4 所

示；



图4

3. 面板接线连接好后：

(1) 将设备背面对准挂架安装孔位，要求设备平行于墙面或者挂架，将设备推入挂架，同时要注意设备的弹片要对准挂架的弹片安装孔，对准后压入，直到设备上的弹片卡入挂架卡扣内。如图 5；

(2) 完成设备安装。如图 6 所示；

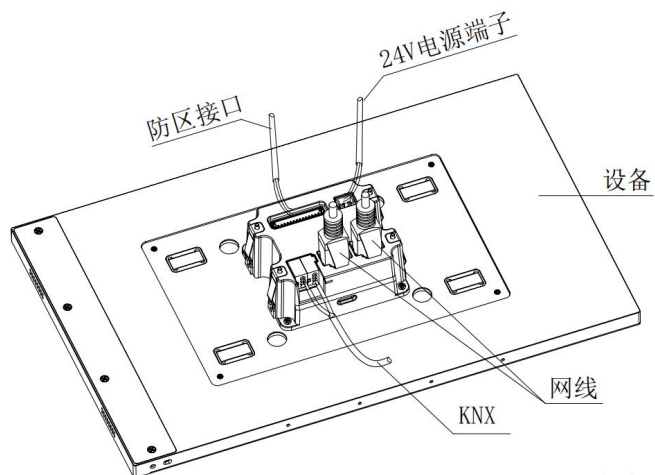
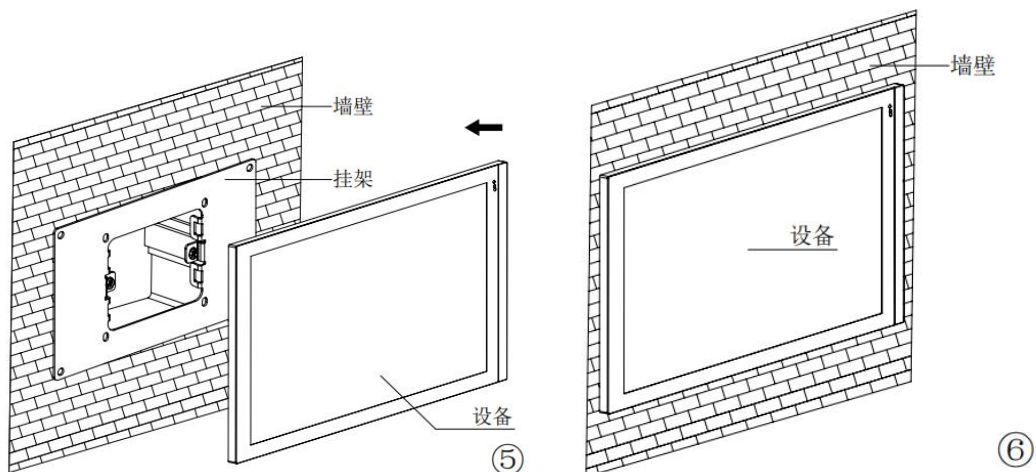

拆卸说明

3. 安装完成后，如需要拆卸，请执行此步骤：将设备水平向外拉拔，弹簧卡扣和磁吸脱落，即可完成拆卸。

如图 6 所示；

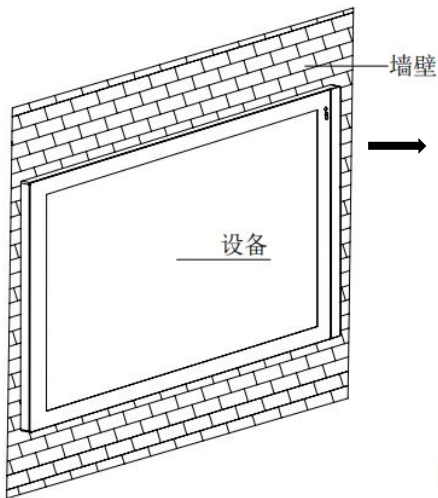

第四章 项目设计和应用

应用程序	最大通讯对象数	最大组地址数	最大联合地址数	安全组地址数
KNX Touch/Intercom/1.2	4986	7000	7000	4000

通用功能

通用功能包括安全密码、屏显示、屏亮度、白天/夜晚功能、夏令时设置、靠近感应功能、LED 和氛围灯设置。

此外还可以选择横屏或竖屏显示，默认 UI 风格，设置屏保、屏锁等功能。

主页上可设置快捷操作功能，以便快速控制常用设备。

设备功能设置

采用卡片式的 UI 风格，最多支持 120 个多功能设备和 120 个简易功能设备通道，且支持独立锁定/解锁每个图标设备。

支持基本控制功能，包含开关、调光、窗帘、值发送、色温、颜色控制(RGB、RGBW、RGBCW)、背景音乐、温控功能、空调控制、新风系统控制、并支持空气质量传感器检测值显示和能源检测值显示等。

开关指示

主要用于对灯光设备或其它设备的开关状态进行指示。

照明控制

主要用于开关照明设备或对照明设备进行调光，调光方式可采用相对调光、亮度调光，相对+亮度调光或者亮度+色温调光。

RGB 调光和色温控制

主要是针对 RGB、RGBW 或 RGBCW 这 3 种 LED 灯进行调光，采用绝对调光方式。RGBCW 支持 RGB 灯光、色温和亮度的调节，其中色温调节可选择普通控制或直接控制。

窗帘控制

主要用于控制开合帘、卷帘、百叶帘。支持调整窗帘的位置和百叶角度。

空调控制

支持空调开关、设定温度、风速、摆风和定时等功能控制。

温控器功能

温控器主要用来对房间温度进行控制，按照房间的使用或居住者的需求进行自动和优化的冷暖控制。

支持手动或自动切换加热/制冷控制，支持三档风速和自动档风速控制，支持 4 种操作模式：舒适、待机、节能和保护模式，可与窗户触点输入检测和存在传感器检测进行联动控制，及支持定时功能等。

温度设定值支持绝对和相对设置方式，及温度设定值可调范围设置。支持两点式和 PI 控制。

新风控制

支持三档风速调节，开/关热交换，滤网寿命计数，滤网超时报警，滤网重置。

根据 PM2.5、VOC、CO2 浓度进行自动控制。

背景音乐控制

用于控制背景音乐播放，如电源开/关，播放/暂停，上一曲/下一曲，音量调节，静音，播放模式，歌曲名，专辑名和歌手名显示等。

显示能源监测值

可设置电流、电压、功率和能源（电能）显示，这些值通过其他执行器或计量仪器网关来获取得到。

环境状态监测

可设置温度、湿度、PM2.5、PM10、CO2、VOC、AQI、光照度的显示，这些值通过外部传感器来获取得到。

值发送功能

可发送不同数据类型的值。

场景控制

短操作进行场景的调用，长操作可设置为存储场景。

人本照明功能（HCL）

根据设定的时间自动调整亮度和色温，设置一个让人感觉到舒适的照明环境。

周定时功能

可定时发送不同数据类型的值，提供多达 16 个定时控制。在定时功能启用后，在屏设置界面中的周定时器可操作，此界面中可对周定时进行关闭或开启。此外，也可通过总线上的其它设备关掉周定时。

场景组功能

通过调用场景号，可触发 8 个输出报文，每个输出有 5 种不同的数据类型可供选择。共有 8 组场景功能可供设置。

逻辑功能

最多支持 8 个通道的逻辑运算，每个通道最多支持 8 个输入和 1 个逻辑结果输出。

逻辑功能支持与、或、异或、门转换、阈值比较、格式转换、门函数、延时功能和楼梯灯功能。

对讲功能

采用卡片式的 UI 风格，支持基本对讲功能，包括地址簿导入、通讯录管理，SIP 可视对讲通话、语音留言、安防监控、虚拟防区管理等常用功能，

第五章 ETS 系统参数设置说明

5.1 KNX 安全

KNX 安全 S15 智能中控屏是一款符合 KNX 安全标准的 KNX 设备。换言之，可以以安全的方式运行设备。



图 5.1 (1) “KNX Secure” 参数界面

符合 KNX 安全标准的 KNX 设备在 ETS 上会有提示，界面如图 5.1(1)所示：



KNX 数据安全在此设备中可用，通过加密和安装身份验证有效地保护用户数据免受未经授权的访问和操作。ETS 可以激活或者不激活安全功能。这需要详细的专业知识。

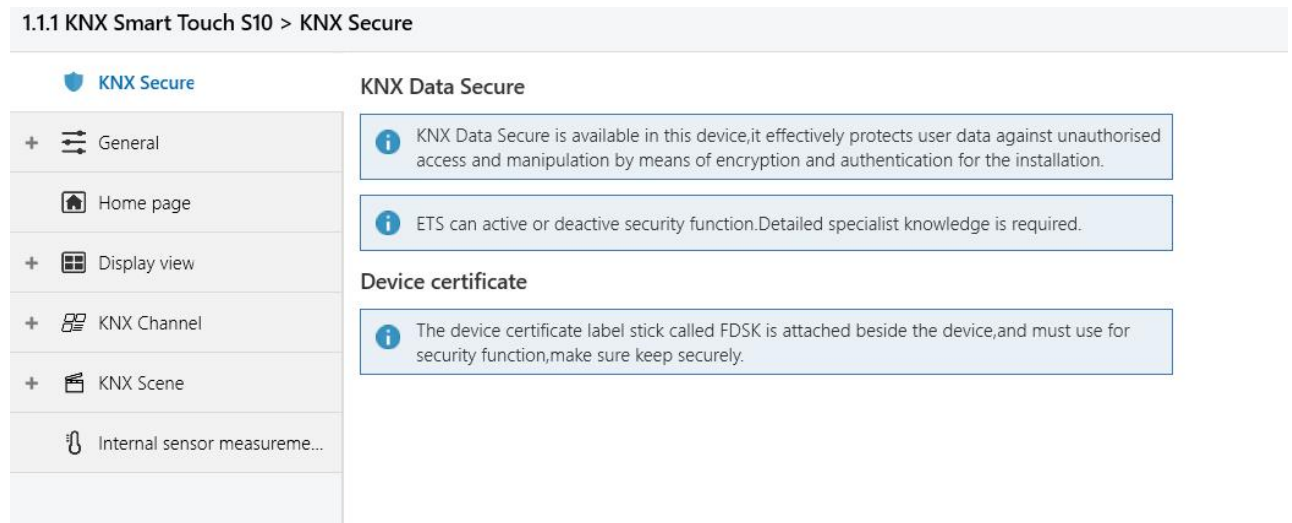
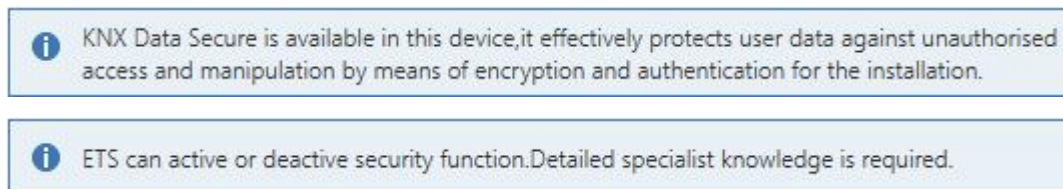

设备旁贴有名为 FDSK 的设备证书标签，用于安全功能，确保安全保存。

如果 ETS 项目中激活安全功能，在设备调试期间必须考虑以下信息：

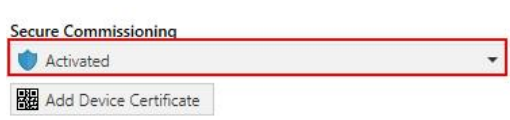

- ❖ 将 KNX 安全设备导入项目后，必须立即分配项目密码，这将保护项目免受未经授权的访问。

密码必须保存在安全的地方——没有它就无法访问项目（即使是 KNX 协会或本厂商也无法访问它）！

没有项目密码，调试密钥也将导入不了。

- ❖ 调试 KNX 安全设备（首次下载）时需要一个调试密钥。此密钥（FDSK = 出厂默认设置密钥）

包含在设备侧面的贴纸上，必须在首次下载之前将其导入 ETS：

- ◇ 首次下载设备时，ETS 中会打开一个窗口，提示用户输入密钥，如下图 5.1 (2)。

此密钥也可以使用 QR 扫描仪从设备上读取（推荐）。



图 5.1(2) Add Device Certificate 窗口

- ◇ 此外，所有安全设备的密钥都可以预先输入 ETS。

此操作在项目概览页面的“Security”选项卡下完成，如下图 5.1(3)。

也可以在项目中，给选择的设备添加密钥“Add Device Certificate”，如下图 5.1(4)。

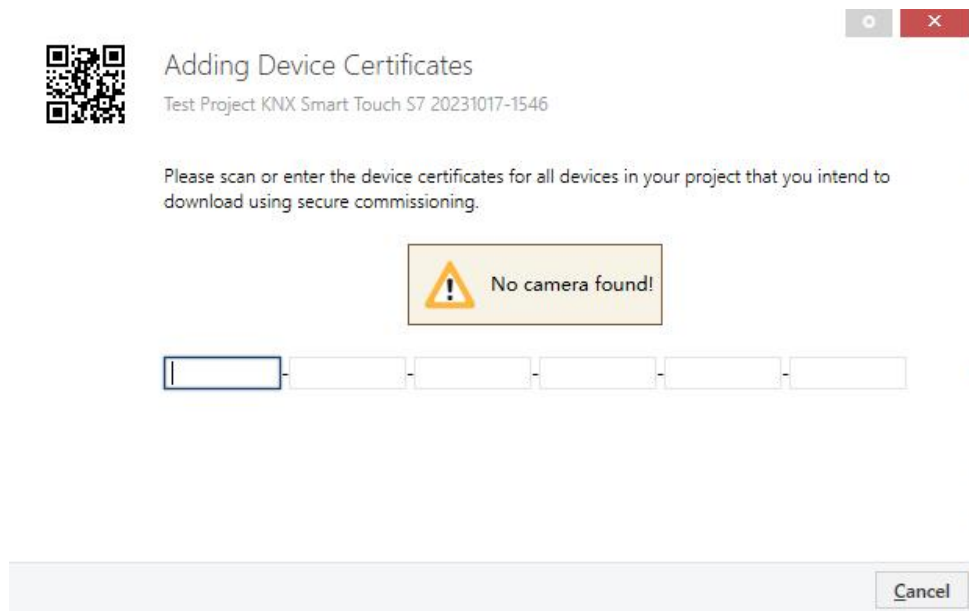

图 5.1(3) Add Device Certificate



图 5.1(4) Add Device Certificate

◇ 设备上贴有一张贴纸，可以用于查看 FDSK。

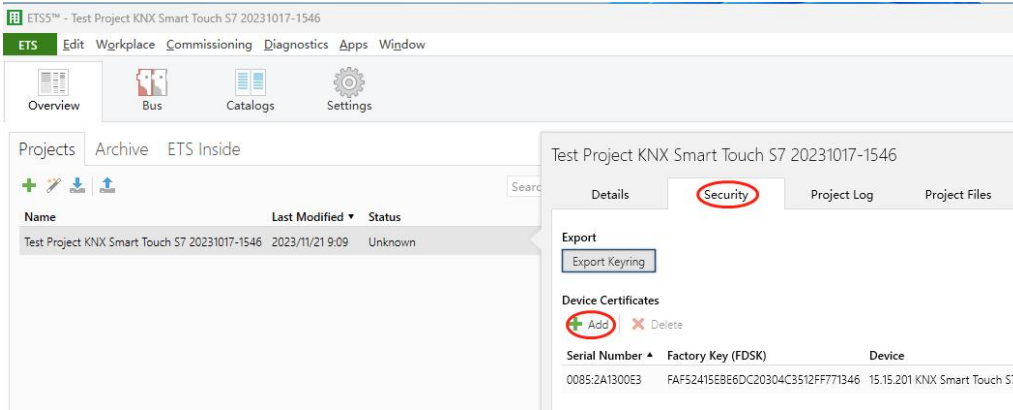
如果没有 FDSK，则在重置后将无法在 KNX 安全模式下操作设备。

FDSK 仅用于初始调试，在输入初始 FDSK 后，ETS 会分配新的密钥，如下图 5.1(5)。

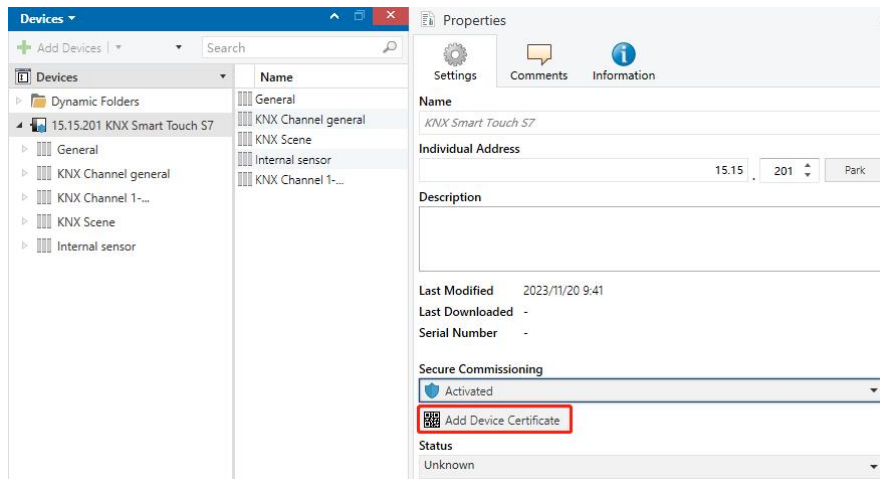
仅当设备重置为其出厂设置时（例如，如果设备要在不同的 ETS 项目中使用），才需要再次使用初始 FDSK。



图 5.1(5)

示例：

如果此数据库需要适配另外的设备，不再是原来的设备。在数据库下载到一个新的设备时，会出现以下提示，图 5.1(6)左，点击“**Yes**”，会出现“Add Device Certificate”的窗口，输入新设备的初始 FDSK，且需要重置此设备到出厂设置（如果此设备仍是出厂设置则不需要；如果已被使用过，则需要，否则出现以下错误提示，图 5.1(6)右），才可以下载成功。

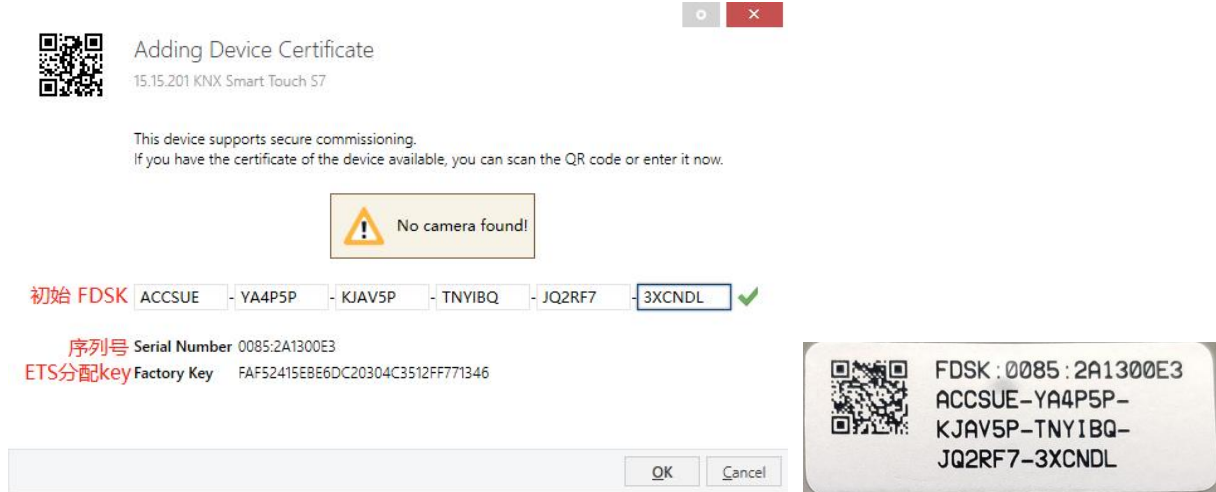

图 5.1(6) 示例

无论是在同一工程中更换设备，还是同一设备更换到不同的工程中，处理方式都是类似的：**重置设备到出厂设置，重新分配 FDSK。**

设备下载之后，标签“Add Device Certificate”变成灰色，表示此设备的密钥已分配成功。

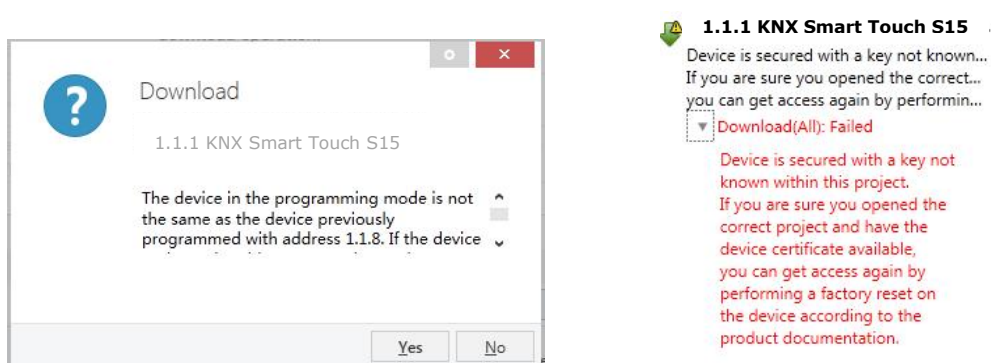

图 5.1(7)

ETS 生成和管理密钥：

可以根据需要导出密钥和密码，如下图 5.1(8)，导出的文件后缀名为.knxkeys。

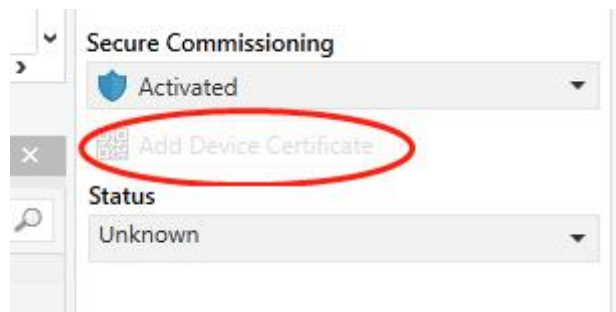

图 5.1(8)

注意：任何用于对 KNX 安全设备进行编程的 USB 接口都必须支持“长帧”，否则 ETS 会出现下载失败提示。

5.2 参数设置界面 “General”

5.2.1 参数设置界面 “General setting”

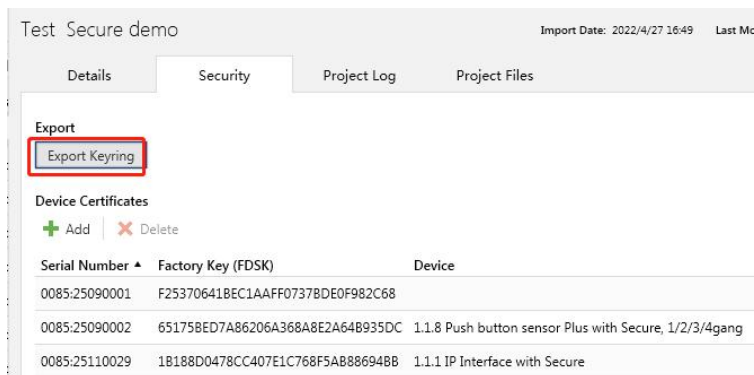
参数设置界面“General setting”如图 5.2.1 所示，这里主要设置设备的通用设置，如 密码保护功能、白天夜晚模式输出、夏令时、密码保护功能、靠近感应等。

1.1.1 KNX Smart Touch S10 > General > General setting

<ul style="list-style-type: none"> KNX Secure General General setting Security setting Night mode setting Coordinates location setting Summer time setting Proximity setting Advanced setting Home page Display view KNX Channel KNX Scene Internal sensor measureme... 	<p>Send delay after voltage recovery [0..15] <input type="text" value="0"/> s</p> <p>Send request delay between status objects <input type="text" value="100"/> ms</p> <p>Send cycle of In operation telegram [1..240,0=inactive] <input type="text" value="0"/> s</p> <p>Delay time for exiting setting status <input type="text" value="3.0"/> s</p> <p>Long operation for touch after <input type="text" value="0.5"/> s</p> <p>Cyclically send date and time [0...255,0=inactive] <input type="text" value="0"/> h</p> <p>Delay time for back to homepage after no operation [0..255,0=inactive] <input type="text" value="15"/> s</p> <p>Screen display setting</p> <p>Temperature display units <input checked="" type="radio"/> Celsius(°C) <input type="radio"/> Fahrenheit(°F)</p> <p>Interface Language <input type="text" value="English"/></p> <p><i>Note: The codepage option in the property of project must select the Unicode(UTF-8)</i></p> <p>UI theme is <input type="text" value="1"/></p> <p>Theme preview </p> <p>Date display format <input checked="" type="radio"/> yyyy/mm/dd <input type="radio"/> dd/mm/yyyy</p>
--------------------------------------------------------------------------------------------------------------------------------------------------------------------------------------------------------------------------------------------------------------------------------------------------------------------------------------------------------------------------------------------------------------------	-----------------------------------------------------------------------------------------------------------------------------------------------------------------------------------------------------------------------------------------------------------------------------------------------------------------------------------------------------------------------------------------------------------------------------------------------------------------------------------------------------------------------------------------------------------------------------------------------------------------------------------------------------------------------------------------------------------------------------------------------------------------------------------------------------------------------------------------------------------------------------------------------------------------------------------------------------------------------------------------------------------------------------------------------------------------------------------------------------------------------------------------------------------------------------------------------------------------------------------------



图 5.2.1 “General setting” 参数设置界面

参数“Send delay after voltage recovery [0..15]”

此参数设置设备在上电复位后，发送报文到总线上的延时时间。可选项：**0..15**

该设置不包含设备初始化时间，且延时期间接收的总线报文会被记录。

参数“Send request delay between status objects”

此参数设置发送状态对象请求报文的间隔时间。可选项：

50ms

100ms

200ms

参数“Send cycle of In operation telegram [1..240,0=inactive]s”

此参数设置此设备通过总线循环发送报文指示此模块正常运行的时间间隔。当设置为“0”时，对象“In operation”将不发送报文。若设置不为“0”时，对象“In operation”将按设定的时间周期发送一个逻辑为“1”的报文到总线。可选项：**0...240, 0=循环发送禁止**

为了尽可能降低总线负载，应根据实际需要选择最大的时间间隔。

参数“Delay time for exiting setting status”

此参数设置自动退出设置状态的延时时间，主要用于温控、空调、背景音乐的子功能设置。报文实时发送，如设定温度，具体根据 UI 定义。可选项：

1.0s

2.0s

3.0s

4.0s

5.0s

参数“Long operation for touch after”

此参数定义屏上触控时长按的触发时间。可选项：

0.5s

1.0s

2.0s

3.0s

参数“Cyclically send date and time [0...255,0=inactive]h”

此参数设置循环发送日期和时间数据到总线的周期，0 时不发送。可选项：**0...255**

参数“Delay time for back to homepage after no operation[0..255,0=inactive]s”

此参数设置系统不操作自动返回主页的延时时间，任意非主页界面，在无操作一段时间后均会自动返回主页，0 时不自动返回。可选项：**0...255**

Screen display setting 屏显示设置

参数“Temperature display units”

此参数设置温度显示单位。可选项：

Celsius(°C)

Fahrenheit(°F)

参数“Interface Language”

此参数设置屏的界面语言。可选项：

Chinese(Simplified) 中文(简体)

Spanish 西班牙语

Chinese(Traditional) 中文(繁体) **Russian 俄罗斯语**

English 英文

Arabic 阿拉伯语

German 德语

Polish 波兰语

French 法语

Portuguese 葡萄牙语

Other 其他

当选择中文时显示提示：

 警告：请务必确保工程属性里的编码页选项为UTF-8，否则中文显示将会异常

当选择非中文时显示提示：

 Note:The codepage option in the property of project must select the Unicode(UTF-8)

注意：应用版本为 4.1.0 以下的，界面语言仅支持简体中文和英文。

——参数“Language name”

当界面语言选择 Other，此参数可见，用于输入语言的名称。设备将根据名称到语言库中寻找相匹配的语言进行显示。寻找不到时默认显示英文。

目前已支持的其他语言有 norwegian(挪威语)、italian(意大利语)、farsi(波斯语)、hebrew(希伯来语)。

注意：选择 Other 选项时，需与厂商确认是否支持此种语言，及对应的语言名称。

UTF-8 设置如下图所示：

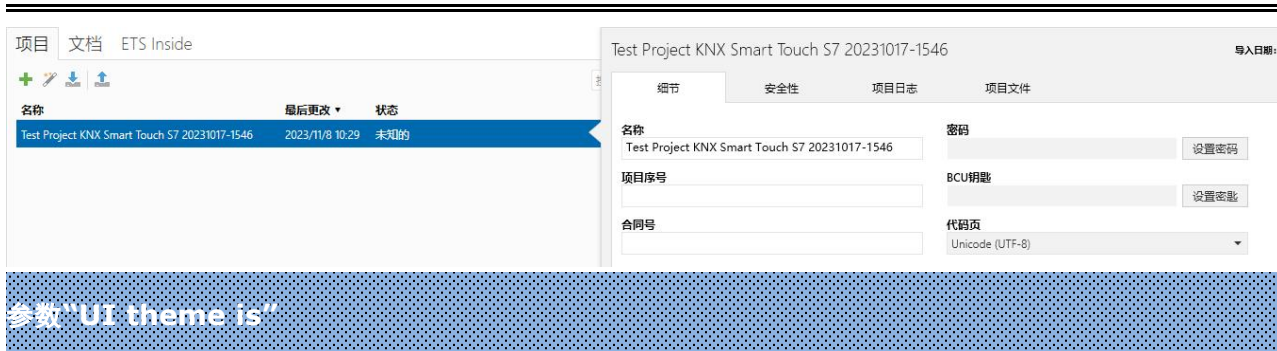

此参数可选择屏的界面主题风格，提供两套风格可选。每套风格都会有默认的背景图。可在屏上修改。

可选项：

- 1
- 2
- 3

参数 "Date display format"

此参数设置屏的日期显示风格。可选项：

yyyy/mm/dd 年月日

dd/mm/yyyy 日月年

Brightness setting 亮度设置

参数 "Screen brightness can be changed via bus"

此参数可设置屏幕亮度是否可通过总线调节。

如果选择，则用于调节屏幕亮度的对象 "Screen backlight brightness" 可见。

Extension function 扩展功能

参数“Night mode”

此参数使能后，夜间模式的设置界面可见。章节 5.2.3 将对此功能进行详细说明。

参数“Proximity function”

此参数使能后，靠近感应功能的设置界面可见。章节 5.2.5 将对此功能进行详细说明。

参数“Intercom function”

此参数使能可视对讲，使能后，设备端可视对讲功能可见。

5.2.2 参数设置界面 “Security setting”

参数设置界面“Security setting”如图 5.2.2 所示，这里主要设置密码功能以及设备通过密码唤醒后向总线发送的报文的数据类型。



图 5.2.2 “Security setting” 参数设置界面

参数“Common password”

此参数设置通用密码,忘记设备密码时用于唤醒屏幕、布防撤防、紧急报警、呼叫转移、进入快捷设置页和页面编辑。

参数“Output object type when wake-up screen via password”

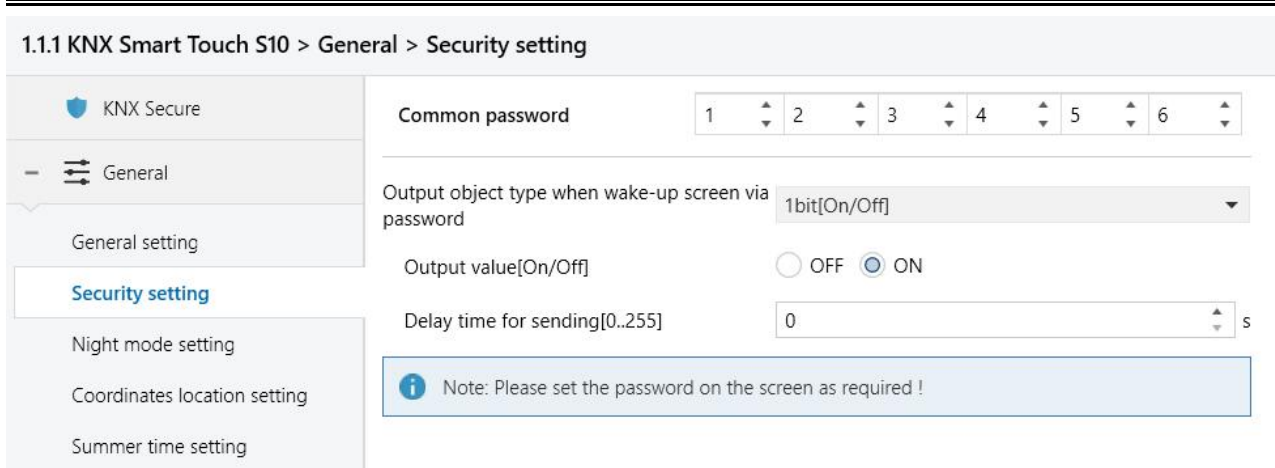
此参数设置在用户输入密码唤醒屏幕时, 是否发送报文到总线上。可选项:

No reaction

1bit[On/Off]

1byte[scene control]

1byte[0..255]

1byte[0..100%]

注意: 密码在屏上设置, 如果屏上的密码没有设置, 此处的设置将无意义。

当参数选项不为“**No reaction**”时, 以下参数可见

——参数“**Output value[On/Off]**”

——参数“**Output scene NO.[1..64]**”

——参数“ Output value[0..255]”

——参数“ Output value[0..100%]”

这些参数根据上一个参数选项设置具体发送的报文值。

可选项：OFF/ON / Scene No.1..Scene No.64 / 0..255 / 0..100%



——参数“ Delay time for sending[0...255]”

此参数设置延时发送值的时间。可选项：0...255

5.2.3 参数设置界面 “Night mode setting”



参数设置界面“Night setting”如图 5.2.3 所示，这里主要设置切换到夜晚或切换到白天的时间

1.1.1 KNX Smart Touch S10 > General > Night mode setting

<div style="text-align: center;">  KNX Secure </div> <div style="text-align: center;">  General </div> <div style="text-align: center;"> General setting </div> <div style="text-align: center;"> Security setting </div> <div style="text-align: center; color: blue;"> Night mode setting </div>	Polarity of normal/night mode <input type="radio"/> Normal=1/Night=0 <input checked="" type="radio"/> Normal=0/Night=1 Switchover normal/night mode Via object Normal/night mode need send read request after voltage recovery <input type="radio"/> No <input checked="" type="radio"/> Yes <div style="border: 1px solid #ccc; padding: 5px; margin-top: 10px;">  Note: Default to normal mode if no response when request after startup </div>
---------------------------------------------------------------------------------------------------------------------------------------------------------------------------------------------------------------------------------------------------------------------------------------------------------------------------------------------------------------------------------------------------------------------------------------------------------------------------------------------------------------------------------	----------------------------------------------------------------------------------------------------------------------------------------------------------------------------------------------------------------------------------------------------------------------------------------------------------------------------------------------------------------------------------------------------------------------------------------------------------------------------------------------------------------------------------------------------------



Via object

1.1.1 KNX Smart Touch S10 > General > Night mode setting

<div style="text-align: center;">  KNX Secure </div> <div style="text-align: center;">  General </div> <div style="text-align: center;"> General setting </div> <div style="text-align: center;"> Security setting </div> <div style="text-align: center; color: blue;"> Night mode setting </div>	Polarity of normal/night mode <input type="radio"/> Normal=1/Night=0 <input checked="" type="radio"/> Normal=0/Night=1 Switchover normal/night mode Depend to certain time Time for switch to night at 18:00 hh:mm Time for switch to normal(day) at 06:00 hh:mm
---------------------------------------------------------------------------------------------------------------------------------------------------------------------------------------------------------------------------------------------------------------------------------------------------------------------------------------------------------------------------------------------------------------------------------------------------------------------------------------------------------------------------------	--------------------------------------------------------------------------------------------------------------------------------------------------------------------------------------------------------------------------------------------------------------------------------------------------

Depend to certain time

1.1.1 KNX Smart Touch S10 > General > Night mode setting

<div style="text-align: center;">  KNX Secure </div> <div style="text-align: center;">  General </div> <div style="text-align: center;"> General setting </div> <div style="text-align: center;"> Security setting </div> <div style="text-align: center; color: blue;"> Night mode setting </div>	Polarity of normal/night mode <input type="radio"/> Normal=1/Night=0 <input checked="" type="radio"/> Normal=0/Night=1 Switchover normal/night mode Depend to sunrise&sunset Time calibration Switching time move to night [-128..127] 0 min Switching time move to day [-128..127] 0 min
-------------------------------------------------------------------------------------------------------------------------------------------------------------------------------------------------------------------------------------------------------------------------------------------------------------------------------------------------------------------------------------------------------------------------------------------------------------------------------------------------------------------------------------	-----------------------------------------------------------------------------------------------------------------------------------------------------------------------------------------------------------------------------------------------------------------------------------------------------------------------------------

Depend to sunrise&sunset

图 5.2.3 “Night mode setting” 参数设置界面

参数“Polarity of normal/night mode”

此参数设置常态（白天）/夜晚模式的对象值。可选项：

Normal=1/Night=0

Normal=0/Night=1

参数"Switchover normal/night mode"

此参数设置白天/夜晚模式的切换方式，状态改变时通过对象"Night mode"发送状态报文。可选项：

Via object**Depend to certain time****Depend to sunrise&sunset**

Via object: 仅根据对象切换状态。重启后默认为白天模式。

Depend to certain time: 根据特定的时间切换白天/夜晚状态。如下午 18:30 切换到夜晚状态，早上 6:30 切换到白天状态。

Depend to sunrise&sunset: 根据日出日落切换白天/夜晚状态。需要定义日出日落参考点的坐标位置，如中国北京，中心位于东经 116°20'、北纬 39°56'。

选择参数"Via object"时，以下参数可见，用于设置对象通过总线切换夜间或白天模式。

参数"Normal/night mode need send read request after voltage recovery"

此参数设置对象 "Night mode" 在总线复位或编程完成时，是否发送读请求。如果发送读请求，LED 将根据回应的正常(白天)/夜间模式的设置亮度进行指示。可选项：

No**Yes**

 Note: Default to normal mode if no response when request after startup

注意：如果启动后请求无回应，则默认为正常模式。即屏背光、LED 状态指示、氛围灯按正常（白天）的模式指示。

选择参数“Depend to certain time”时，以下两个参数可见，用于设置切换到夜晚或白天的时间。

参数“Time for switch to night at”

参数“Time for switch to normal (day) at”

此参数设置切换到夜间/白天状态的时间点，精确到分钟。可选项：**00:00...23:59**

选择参数“Depend to sunrise&sunset”时，以下参数可见，用于设置日出日落时间参考点的坐标位置。

Time calibration 时间校准

参数“Switching time move to night [-128..127]min”

此参数设置相对于日落时间点，切换到夜晚状态的时差。在日落的时间点，再提前或者延迟多久才切换到夜晚状态。可选项：**-128..127**

参数“Switching time move to day [-128..127]min”

此参数设置相对于日出时间点，切换到白天状态的时差。在日出的时间点，再提前或者延迟多久才切换到白天状态。可选项：**-128..127**

例如，设置-10min，那么将早于日出时间点 10min 切换到白天状态；设置 10min，那么将在日出时间点过后 10min 再切换到白天状态。

5.2.4 参数设置界面 “Coordinates location setting”

参数设置界面“Coordinates location setting”如图 5.2.4 所示，这里主要设置日出/日落的参考点坐标位置。



图 5.2.4 “Coordinates location setting”参数设置界面

参数“Latitude longitude setting location”

此参数设置日出日落时间的参考点，如中国北京“Beijing,China”。

参数“Latitude”

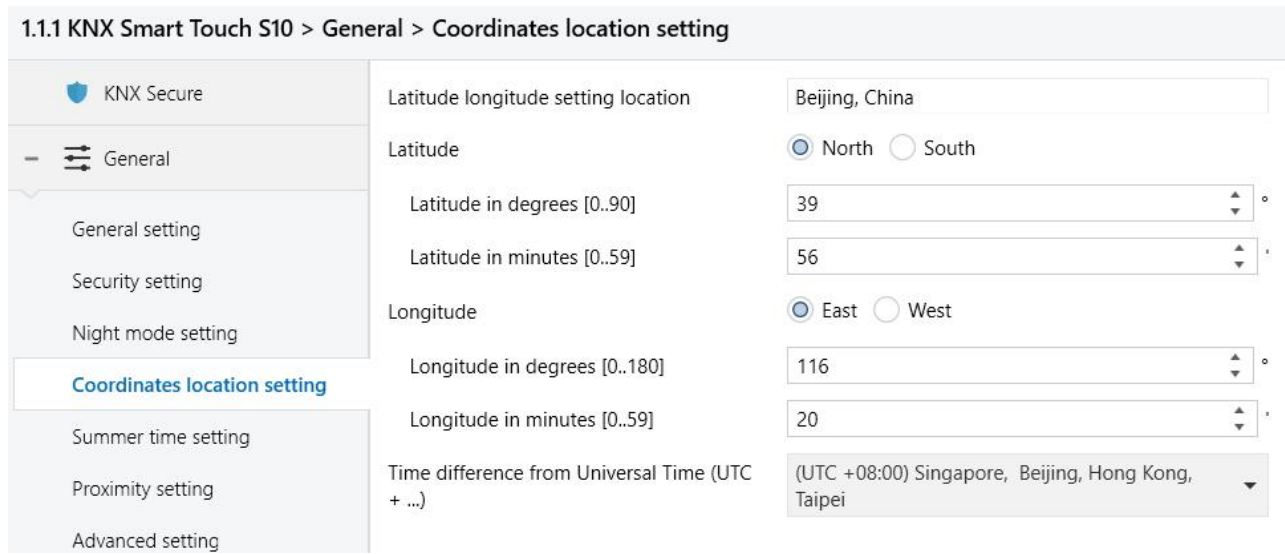
此参数设置日出日落的参考点位置是在南纬，还是北纬。可选项：

South 南纬

North 北纬

——参数“Latitude in degrees [0..90]”

——参数“Latitude in minutes [0..59]”

这两个参数设置纬度。如北京位于北纬 39° 56' 。

参数“Latitude”

此参数设置日出日落的参考点位置是在东经，还是西经。可选项：

East 东经

West 西经

——参数“Longitude in degrees [0..180]”

——参数“Longitude in minutes [0..59]”

这两个参数设置经度。如北京位于东经 116° 20' 。

参数“Time difference from Universal Time (UTC + ...)”

参数设置世界标准时间的时差。可选项：

(UTC -12: 00) International Date Line West 国际日期变更线西

(UTC -11: 00) Samoa 萨摩亚群岛

.....

(UTC +11: 00) Magadan, Salomon Islands, New Caledonia 马加丹, 所罗门群岛, 新喀里多尼亚

(UTC +12: 00) Auckland, Wellington, Fiji 奥克兰, 惠灵顿, 斐济

5.2.5 参数设置界面 “Summer time setting”



图 5.2.5 参数设置界面“Summer time setting”参数设置界面

参数“Summer time”

此参数设置是否使能夏令时间。可选项：

Disable

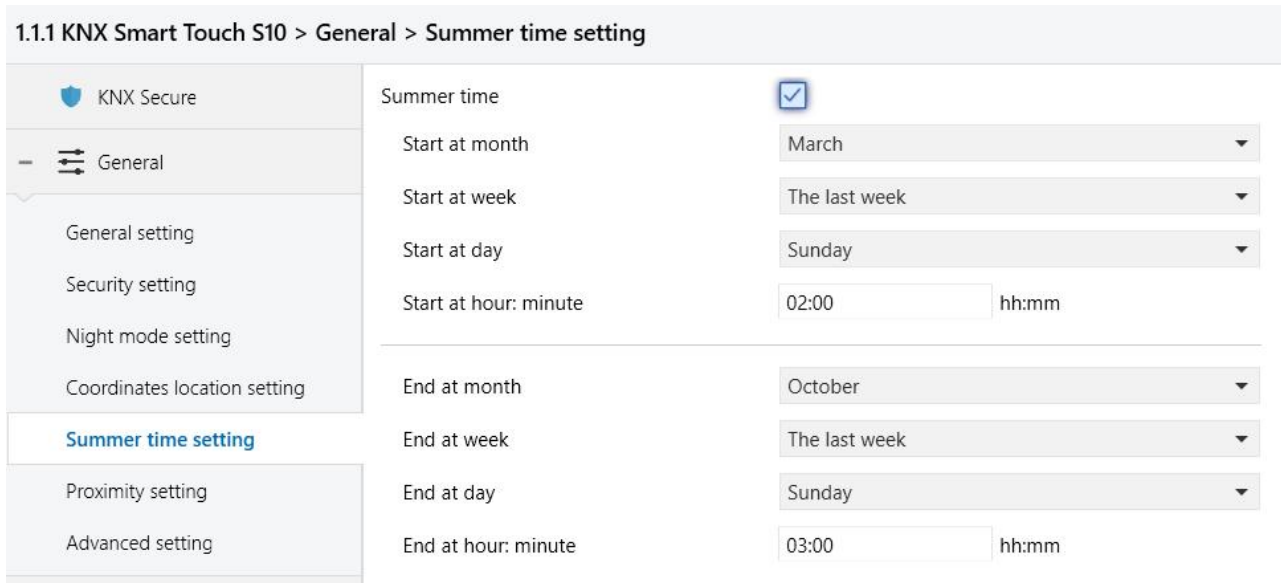
Enable

参数“Summer time”使能时，以下参数可见，用于设置夏令开始/结束的时间。

——参数“Start at month”

——参数“End at month”

这两个参数设置夏令时开始或结束的月份。可选项：

January 一月

February 二月

...

December 十二月

——参数“Start at week”

——参数“End at week”

这两个参数设置夏令时开始或结束的周数。可选项：

The first week 第一周

The second week 第二周

...

The last week 最后一周

——参数“Start at day”

——参数“End at day”

这两个参数设置夏令时开始或结束的星期。可选项：

Monday 星期一

Tuesday 星期二

...

Sunday 星期日

——参数“Start at hour:minute”

——参数“End at hour:minute”

这两个参数设置夏令时开始或结束的时间点，精确到分钟。可选项：**00:00-23:59**

以美国时间为例，设置夏令时从 3 月的第二个星期日 02h:00min 开始至每年 11 月的第一个星期日

02h:00min 结束，则在夏令时开始到结束时间内，当到达开始时间点时，系统默认加快一个小时，设备显示时间为 03h:00min；当到达结束时间点时，系统默认减慢一个小时，设备显示时间为 02h:00min。

注意：开始日期和结束日期不能设置为相同。如果开始和结束的参数设置为同一个月份、周数和星期，该设置将会被忽略并恢复为默认。如果只月份和周数设置为相同时，也会忽略。

5.2.6 参数设置界面 “Proximity setting”

参数设置界面“Proximity setting”如图 5.2.6 所示。这里主要设置靠近感应功能，可设置当人体靠近时所发送的报文，及发送报文的延时时间。



图 5.2.6 “Proximity setting”参数设置界面

参数“The Proximity function triggered via”

此参数设置靠近感应功能的触发方式。可选项：

Sensor

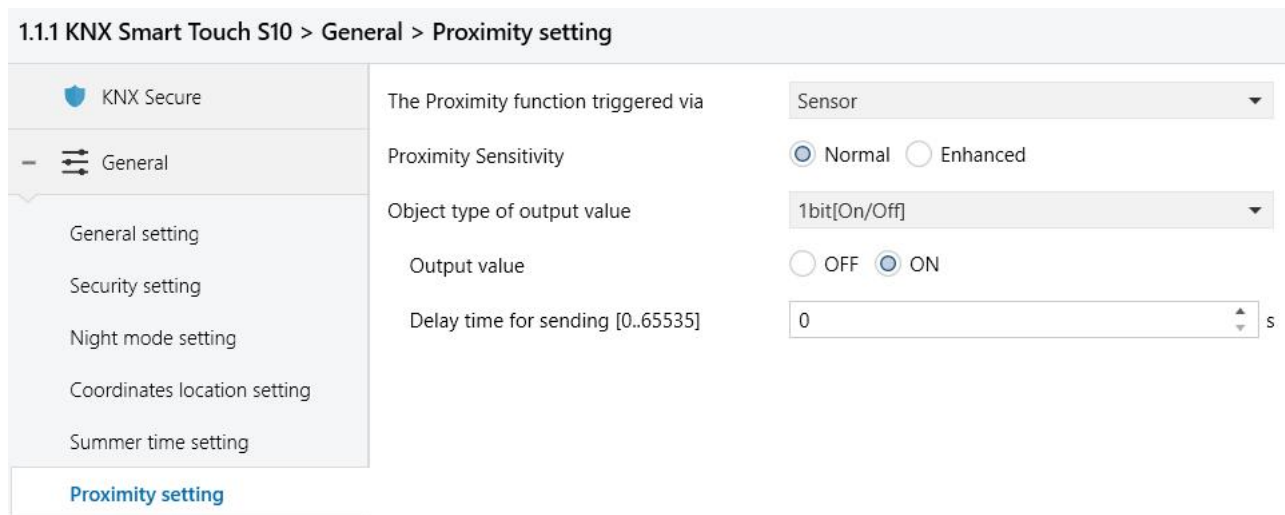
Proximity object**Sensor or Proximity object**

选择“Sensor or Proximity object”时，当感应通过对象触发时，不会发送输出值。

以下参数选择“Sensor”或者“Sensor or Proximity object”时可见。

参数“Proximity Sensitivity”

此参数设置靠近感应的灵敏度。普通感应距离 30cm，增强感应距离 60cm

可选项：

Normal 普通感应距离

Enhanced 增强感应距离

参数“Object type of output value”

此参数设置当检测到人体靠近感应区域时，分别向总线发送的报文的数据类型。可选项：

1bit[On/Off]

1byte [scene control]

1byte[0..255]

1byte[0..100%]

——参数“Output value[On/Off]”

——参数“Output scene NO.[1..64]”

——参数“Output value[0..255]”

——参数“Output value[0..100%]”

这些参数设置当设备检测到人体靠近感应区域时向总线发送的报文值，值的范围由选择的数据类型决定。

——参数“Delay time for sending[0..65535]”

此参数设置报文发送的延时时间。可选项：**0..65535**

注：报文发送延时时间，延时时间内，多次靠近，不会重复发送报文。

5.2.7 参数设置界面 “Advanced setting”

参数设置界面“Advanced setting”如图 5.2.8 所示。用于使能 HVAC 控制器、人本照明控制、周定时功能、警报功能、逻辑功能、场景组功能。

详细介绍看章节 5.3-5.8



图 5.2.7 “Advanced setting”参数设置界面

5.3 参数设置界面 “HVAC controller”

该界面在图 5.2.8“Advanced setting”中的参数“HVAC controller”选择使能时可见，如图 5.3 所示。

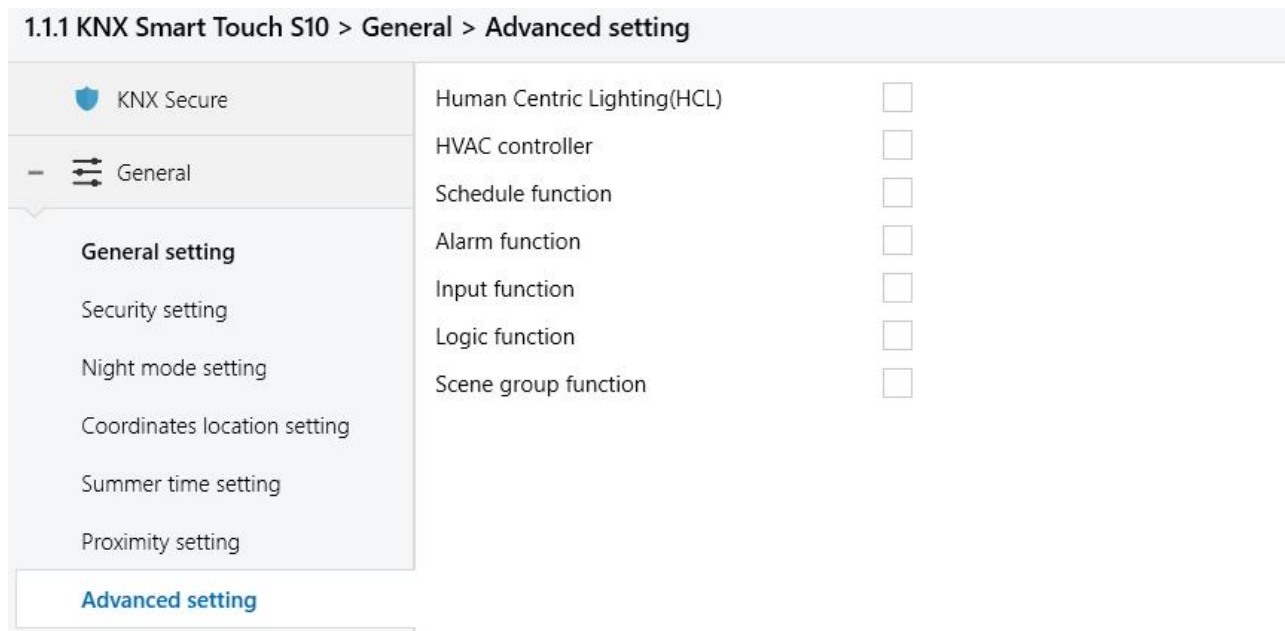

图 5.3 “HVAC controller”参数设置界面

参数“Number of controllers (max.6)”

此参数设置 HVAC 控制器的数量。可选项：**1-6**

5.3.1 参数设置界面 “Cotroller x-Room temperature controller(RTC)”(x=1~6)

此界面在控制器类型选择“Room temperature controller (RTC)”时可见，如图 5.3.1 所示。

1.1.1 KNX Smart Touch S10 > HVAC controller > Controller 1-...

<ul style="list-style-type: none"> — HVAC controller <ul style="list-style-type: none"> Function setting — Controller 1-... <ul style="list-style-type: none"> Setpoint Heating control Fan auto.control — Schedule function <ul style="list-style-type: none"> Function setting Schedule 1-... — Alarm function <ul style="list-style-type: none"> Function setting Alarm 1-... — Input function <ul style="list-style-type: none"> Function setting Input 1 - ... — Logic function <ul style="list-style-type: none"> Function setting 	<p>Description (max 30char.)</p> <p>Controller type</p> <p>Room temperature reference from</p> <p>Control value after temp. error[0..100] (if 2-point control, set value '0'=0, set value '>0'=1)</p> <p>Room temperature control mode</p> <p>Operation mode</p> <p>Controller status after download</p> <p>Controller status after voltage recovery</p> <p>Extended comfort mode [0..255,0=inactive]</p> <p>1 bit object function for operation mode</p> <p>1 bit object for standby mode</p> <p>Fan speed auto.control function</p> <p>Window contact input function</p> <p>Delay for window contact [0..65535]</p> <p>Controller mode for open window</p> <p>Bus presence detector function</p>	<p><input type="text"/></p> <p><input checked="" type="radio"/> Room temperature controller (RTC) <input type="radio"/> Ventilation controller</p> <p>Internal sensor</p> <p>0 %</p> <p>Heating</p> <p><input checked="" type="checkbox"/></p> <p>Comfort mode</p> <p>As before voltage failure</p> <p>0 min</p> <p><input checked="" type="checkbox"/></p> <p><input checked="" type="checkbox"/></p> <p>Default Value: Unchecked</p> <p><input checked="" type="checkbox"/></p> <p><input checked="" type="checkbox"/></p> <p>15 s</p> <p><input type="radio"/> Economy mode <input checked="" type="radio"/> Frost/heat protection</p> <p><input checked="" type="checkbox"/></p>
------------------------------------------------------------------------------------------------------------------------------------------------------------------------------------------------------------------------------------------------------------------------------------------------------------------------------------------------------------------------------------------------------------------------------------------------------------------------------------------------------------------------------------------------------------------------------------------------------------------------------------------------------------------------------------------------------------------------------------------------------------------------------------------------------------	---------------------------------------------------------------------------------------------------------------------------------------------------------------------------------------------------------------------------------------------------------------------------------------------------------------------------------------------------------------------------------------------------------------------------------------------------------------------------------------------------------------------------------------------------------------------------------------------------------------------------------------------------------------------------------------------------------------	------------------------------------------------------------------------------------------------------------------------------------------------------------------------------------------------------------------------------------------------------------------------------------------------------------------------------------------------------------------------------------------------------------------------------------------------------------------------------------------------------------------------------------------------------------------------------------------------------------------------------------------------------------------------------------------

图 5.3.1 “Controller x-Room temperature controller(RTC)”(x=1~6)参数设置界面

参数“Description (max 30char.)”

此参数设置通道的自定义描述，最多可以输入 30 个字节。

参数“Controller type”

此参数设置控制器类型。可选项：

Room temperature controller (RTC)

Ventilation controller

参数“Room temperature reference from”

此参数设置温控器的温度参照来源。可选项：

Internal sensor 内部传感器

External sensor 外部传感器

Internal and External sensor combination 内部和外部传感器组合

选择 **Internal sensor combine with External sensor** 时，以下参数可见。

——参数“Combination ratio”

此参数设置内部传感器和外部传感器测量温度的比重。可选项：

10% Internal to 90% External

20% Internal to 80% External

...

80% Internal to 20% External

90% Internal to 10% External

例如，选项为“40% Internal to 60% External”，那么内部传感器占有 40% 的比例，外部传感器占有 60% 的比例，控制温度 = (内部传感器的温度 × 40%) + (外部传感器的温度 × 60%)，设备的温控器功能将根据计算出的温度进行温度控制和显示。

两个传感器组合检测时，当其中一个传感器出错时，则采用另外一个传感器检测的温度值。

——参数“Period for request external sensor [0...255,0=inactive]”

此参数设置本设备向外部温度传感器发送温度读请求的时间周期。可选项：**0...255min**

——参数“Send temperature when the result change by [0...10]”

此参数设置当温度改变一定量时，发送当前温度测量值到总线上。可选项：

Disable

0.5K

1.0K

1.5K

...

10K

——参数“Cyclically send temperature [0...255,0=inactive]”

此参数设置温度测量值周期发送到总线上的时间，0 不发送。可选项：**0...255min**

参数“Control value after temp. error [0..100](if 2-point control, set value '0'=0, set value '>0'=1)”

此参数设置在温度传感器错误时的控制值。可选项：**0..100%**

如果控制方式是两点式开关控制模式，那么参数值为 0 时，控制值为 0；参数值大于 0 时，控制值为 1。

参数“Room temperature control mode”

此参数用于设置温控器的控制模式。可选项：

Heating

Cooling

Heating and Cooling

Heating and Cooling：可实现加热，也可实现制冷。同时，以下参数可见。

——参数“Heating/Cooling switchover”

此参数设置加热/制冷的切换方式。可选项：

Via object

Automatic changeover

——参数“Heating/Cooling status after download”

此参数设置下载完成后，开启 RTC 时设备的加热/制冷控制模式。可选项：

Heating

Cooling

——参数“Heating/Cooling status after voltage recovery”

此参数设置上电复位后，开启 RTC 时设备的加热/制冷控制模式。可选项：

Heating 加热

Cooling 制冷

As before voltage failure 掉电前的模式状态

As before voltage failure: 在设备上电复位后的控制模式恢复到掉电之前或重启之前的状态。若是设备第一次使用或新使能的设备功能，设备启动后的控制模式处于不确定状态，此时需要人为去选择控制模式。

——参数“Room temperature control system”

此参数设置温控器控制系统的类型，即风机盘管进出水的管道类型。可选项：

2 pipes system

4 pipes system

2 pipes system: 两管系统，为加热制冷共用一条进出水管，即热水和冷水都共用一个阀门控制。

4 pipes system: 四管系统，为加热制冷分别拥有各自的进出水管，需两个阀门分别控制热水和冷水的进出。

参数“Operation mode”

此参数设置是否使能温控器的操作模式。

当参数“Operation mode”不使能时，以下参数可见。

——参数“Initial setpoint temperature”

此参数设定温度的初始值。可选项：

10.0

10.5

...

34.5

35.0

——参数“Min./Max. setpoint temperature [5..37]”

这两个参数用于限制温度设定值的可调节范围。设置的最小值需小于最大值。温度设定值超出限值范围，则按限值输出。可选项：

5° C

6° C

37° C

以下参数在“Room temperature control mode”选择“**Heating and Cooling**”

且“**Heating/Cooling switchover**”选择“**Automatic changeover**”时可见。

——参数“**Upper /Lower dead zone**”

这两个参数设置自动切换加热/制冷的死区限值。可选项：

0.5K

1.0K

...

10.0K

在加热下，当实际温度大于或等于当前设定温度+上限死区时，模式从加热切换到制冷；

在制冷下，当实际温度小于或等于当前设定温度-下限死区时，模式从制冷切换到加热。

当参数“**Operation mode**”使能时，以下参数可见。

——参数“**Controller status after download**”

设置下载完成后，开启温控器时的操作模式。可选项：

Standby mode 待机模式

Comfort mode 舒适模式

Economy mode 节能模式

——参数“**Controller status after voltage recovery**”

此参数用于上电复位后，开启 RTC 时的操作模式。可选项：

Comfort mode 舒适模式

Standby mode 待机模式

Economy mode 节能模式

Frost/heat protection 保护模式**As before voltage failure 掉电前的模式状态****——参数“Extended comfort mode [0..255,0=inactive] min”**

此参数设置舒适模式的延长时间。值>0，延长舒适模式激活，1bit 对象“comfort mode”可见。可

选项：**0..255**

当对象接收到报文 1 时，舒适模式激活，在延时期间，如果再次收到报文 1，时间重新计时，一旦时间计时完成，舒适模式返回到之前的操作模式。如果在延时期间，有新的操作模式，则会退出此舒适模式。

开关操作时会退出计时，加热/制冷切换则不会。

——参数“1 bit object function for operation mode”

此参数设置是否使能可见操作模式的 1bit 对象。当对象发送报文 1，相应的模式激活；从总线接收到舒适、节能和保护对象值都为 0 时，执行待机模式。

——参数“1 bit object for standby mode”

上一个参数使能时，此参数可见。设置是否使能可见待机模式的 1bit 对象。

参数“Fan speed auto control function ”

此参数设置是否使能风速自动控制页面。

参数“Window contact input function ”

当 RTC 操作模式使能时，此参数可见。设置是否使能与窗户状态关联。

当参数“Window contact input function”使能时，以下参数可见。

——参数“Delay for window contact [0..65535]s”

当 RTC 操作模式使能且窗帘触点输入使能时，此参数可见。设置窗户触点检测的延时时间，即当窗户打开时间在该参数设定的值以内，则认为窗户没有被打开，如果时间超过该设定值，则认为窗户已经被打开。可选项：**0..65535**

——参数“Controller mode for open window”

当 RTC 操作模式使能且窗帘触点输入使能时，此参数可见。如果窗户处于 open 状态，则可根据配置来执行相应操作。（对于操作模式，如果有接收到可操作开关、设定温度及加热/制冷模式的控制报文则在后台记录，在窗户关上后进行执行。如果没有接收到记录，则恢复到开窗前的模式状态。）可选项：

Economy mode 节能模式

Frost/heat protection 保护模式

参数“Bus presence detector function”

当 RTC 操作模式使能时，此参数可见。设置是否使能与人体存在关联。

如果检测到人体存在，则进入舒适模式，人离开后则恢复到原先的模式。如果期间有总线/手动调节模式，则离开后，不会恢复到之前的模式状态。（如果循环接收到存在状态，不会重触发舒适模式，离开后才可以。）

5.3.1.1 设置参数界面 “Setpoint”

此界面在控制器类型选择“Room temperature controller (RTC)”时可见，根据控制模式显示，如

图 5.3.1.1 所示。

1.1.1 KNX Smart Touch S10 > HVAC controller > Controller 1-... > Setpoint

<ul style="list-style-type: none"> — HVAC controller <ul style="list-style-type: none"> Function setting — Controller 1-... <ul style="list-style-type: none"> Setpoint Heating control Cooling control Fan auto.control — Schedule function <ul style="list-style-type: none"> Function setting Schedule 1-... — Alarm function <ul style="list-style-type: none"> Function setting Alarm 1-... — Input function <ul style="list-style-type: none"> Function setting Input 1- ... — Logic function 	Setpoint method for operating mode <input checked="" type="radio"/> Relative <input type="radio"/> Absolute Base setpoint temperature 20.0 °C Additional setpoint offset for setpoint adjustment <input type="radio"/> Disable <input checked="" type="radio"/> Enable Step of setpoint offset <input checked="" type="radio"/> 0.5K <input type="radio"/> 1K Min. setpoint offset [-10..0] -5 K Max. setpoint offset [0..10] 5 K
	Heating Reduced heating in standby mode [0..10] 2 K Reduced heating in economy mode [0..10] 4 K Setpoint temperature in frost protection mode [5..10] 7 °C
	Cooling Increased cooling in standby mode [0..10] 2 K Increased cooling in economy mode [0..10] 4 K Setpoint temperature in heat protection mode [30..37] 35 °C
	Min. setpoint temperature [5..37] 10 °C Max. setpoint temperature [5..37] 32 °C

相对调整参数设置

1.1.1 KNX Smart Touch S10 > HVAC controller > Controller 1-... > Setpoint

<ul style="list-style-type: none"> — HVAC controller <ul style="list-style-type: none"> Function setting — Controller 1-... <ul style="list-style-type: none"> Setpoint Heating control Cooling control Fan auto.control — Schedule function <ul style="list-style-type: none"> Function setting Schedule 1-... — Alarm function <ul style="list-style-type: none"> Function setting Alarm 1-... — Input function <ul style="list-style-type: none"> Function setting Input 1-... 	<p>Setpoint method for operating mode <input type="radio"/> Relative <input checked="" type="radio"/> Absolute</p> <p>Heating</p> <p>Setpoint temperature in comfort mode [5..37] 21 °C</p> <p>Setpoint temperature in standby mode [5..37] 19 °C</p> <p>Setpoint temperature in economy mode [5..37] 17 °C</p> <p>Setpoint temperature in frost protection mode [5..10] 7 °C</p> <p>Cooling</p> <p>Setpoint temperature in comfort mode [5..37] 23 °C</p> <p>Setpoint temperature in standby mode [5..37] 25 °C</p> <p>Setpoint temperature in economy mode [5..37] 27 °C</p> <p>Setpoint temperature in heat protection mode [30..37] 35 °C</p> <p>Note: The heating setpoint must be always less than the cooling setpoint.</p> <p>Min. setpoint temperature [5..37] 10 °C</p> <p>Max. setpoint temperature [5..37] 32 °C</p>
-----------------------------------------------------------------------------------------------------------------------------------------------------------------------------------------------------------------------------------------------------------------------------------------------------------------------------------------------------------------------------------------------------------------------------------------------------------------------------------------------------------------------------------------------------------------------------------------------------------------------------------------------------------------------------------------------------------------------------------------	-------------------------------------------------------------------------------------------------------------------------------------------------------------------------------------------------------------------------------------------------------------------------------------------------------------------------------------------------------------------------------------------------------------------------------------------------------------------------------------------------------------------------------------------------------------------------------------------------------------------------------------------------------------------------------------------------------------------------------------------------------------------------------------------------------------------------------------------------------

绝对调整参数设置

图 5.3.1.1 “Setpoint”参数设置界面

参数“Setpoint method for operating mode”

此参数设置温度设定值的调整方式。可选项：

Relative**Absolute**

Relative: 相对调整方式，节能和待机模式的温度设定值将参考定义的基准温度设定值。

Absolute: 绝对调整方式，各个模式都有自己独立的温度设定值。

温度设定值采用相对调整方式时，以下设置参数可见。

参数“Base setpoint temperature”

参数设置设定温度的基准值，房间舒适模式的初始设定温度由此获得。可选项：

10.0

10.5

...

35.0

基准值可通过总线对象“Base setpoint adjustment”修改，且更改后，在设备掉电后会保存新值。

当前的基准温度 = 修改的基准温度 +/- 累计偏移量（如果存在）

在调整当前操作模式的设定温度时，基准值会随着变，但各模式的相对温度是不变的。待机、节能和舒服模式的相对温度在以下参数中设置。

参数“Additional setpoint offset for setpoint adjustment”

此参数设置是否使能设定值调整的附加设定值偏移功能，主要用于通过 1bit 的对象实现设定温度的调整。可选项：

Disable

Enable

通过 1bit 对象“Setpoint offset”增加/减少偏移量，间接调整设定温度，以及通过 2byte 对象“Float offset value”发送偏移量到总线上。另外还可通过 1bit 对象“Setpoint offset reset”对偏移量进行重置，通过 2byte“Float offset value”对象直接修改偏移量。控制模式和操作模式改变时都会保存偏移量。

偏移功能使能时，以下三个参数可见。

——参数“Step of setpoint offset”

此参数设置当接收到报文时，偏移量每增加/减少的步进值，报文 1-增加，报文 0-减少。累计的偏

移量掉电保存。可选项：

0.5K

1K

当前模式的设定温度 = 基准温度 + 模式固定偏移量 + 累积额外偏移量

注意：模式固定偏移量即待机和节能模式相较于舒适模式的偏移，由加热/制冷的以下对应参数设置所决定。累积额外偏移量由 1bit 对象“Setpoint offset”调整，或 2byte 对象“Float offset value”直接修改。

——参数“Min. setpoint offset [-10..0]K”

此参数设置负向偏移（下调设定温度）时，所允许的最大偏移量。可选项：**-10..0**

——参数“Max. setpoint offset [0..10]K”

参数设置正向偏移（上调设定温度）时，所允许的最大偏移量。可选项：**0..10**

Automatic H/C mode changeover dead zone (only for comfort mode)

参数“Upper/Lower dead zone”

仅当控制模式选择“Heating and Cooling”且“Automatic changeover”时，这两个参数可见。设

置上限死区或者下限死区。可选项：

0.5K

1.0K

...

10K

在加热下，当实际温度大于或等于舒适模式的设定值+上限死区时，模式从加热切换到制冷；

在制冷下，当实际温度小于或等于舒适模式的设定值-下限死区时，模式从制冷切换到加热。

参数“Reduced heating in standby mode [0...10]K”

参数“Increased cooling in standby mode [0...10]K”

这两个参数设置待机模式下的温度设定值。可选项：

0K

1K

...

10K

Heating：待机模式的温度设定值为基准值减去该参数设置的值；

Cooling：待机模式的温度设定值为基准值加上该参数设置的值。

参数“Reduced heating in economy mode [0...10]K”

参数“Increased cooling in economy mode [0...10]K”

这两个参数设置节能模式下的温度设定值。可选项：

0K

1K

...

10K

Heating：节能模式的温度设定值为基准值减去该参数设置的值；

Cooling：节能模式的温度设定值为基准值加上该参数设置的值。

参数“Setpoint temperature in frost protection mode [5...10]°C”

此参数设置加热功能霜冻保护模式下的温度设定值。可选项：

5°C

6°C

...

10°C

霜冻保护模式下，当室温下降至该参数设置值时，控制器将会触发一个控制报文，使相关加热执行器输出加热控制，避免温度太低。

参数“Setpoint temperature in heat protection mode [30...37]° C”

此参数设置制冷功能过热保护模式下的温度设定值。可选项：

30°C

31°C

...

37°C

过热保护模式下，当室内温度升高至该参数设置值时，控制器将会触发一个控制报文，使相关制冷执行器输出制冷控制，避免温度太高。

温度设定值采用绝对调整方式时，以下设置参数可见。

参数“Setpoint temperature in comfort [5...37]° C”

参数“Setpoint temperature in standby mode [5...37]° C”

参数“Setpoint temperature in economy mode [5...37]° C”

这些参数设置加热或者制冷功能下，舒适、待机和节能模式下的温度设定值。可选项：

5°C

6°C

...

37°C

参数“Setpoint temperature in frost protection mode [5...10]”

此参数设置加热功能霜冻保护模式下的温度设定值。可选项：

5°C

6°C

...

10°C

参数“Setpoint temperature in heat protection mode [30...37]”

此参数设置制冷功能过热保护模式下的温度设定值。可选项：

30°C

31°C

...

37°C

 Note: The heating setpoint must be always less than the cooling setpoint.

对于绝对调整模式，选择“**Heating and Cooling**”且“**Automatic changeover**”时，显示该提示。同一操作模式的制热设定值必须始终小于或等于制冷设定值，这一点同样适用于“**Via object**”。

1.当环境温度高于制冷当前操作模式下的设定温度时，切换到制冷；环境温度低于制热当前操作模式下的设定温度时，切换到制热。

2.同一操作模式时，无论是总线写入，还是在面板上调节，制冷和制热的设定温度差值保持不变。即调节设定温度时，需同时更新当前模式下制热和制冷的设定温度。

3.对于加热设定值大于制冷设定值这种异常配置，以制冷的设定温度和环境温度来比较判断制冷/加热模式，即当环境温度高于制冷当前操作模式下的设定温度时切换到制冷，环境温度低于制冷当前操作模

式下的设定温度时则切换到制热。

4.从总线接收温度调节报文时，仍需要按照高低阈值做限制处理，即制热和制冷温度既不能低于最低设置温度阈值，也不能高于最高设置温度阈值。

其中，第 2、4 点同样适用于对象切换模式（Via object）。

注意：对于相对/绝对调整，保护模式时，设定温度完全由 ETS 配置。总线接收到的设定值与 ETS 配置的不同步时，设定值不更新且返回到当前的设定温度，以便同步更新总线上其他设备。

5.3.1.2 设置参数界面 “Heating control/Cooling control/Heating/Cooling control”

此界面在控制器类型选择“Room temperature controller (RTC)”时可见，根据控制模式显示，如图 5.3.1.2 所示。

1.1.1 KNX Smart Touch S10 > HVAC controller > Controller 1-... > Heating/Cooling control

<ul style="list-style-type: none"> + KNX Scene Internal sensor measureme... Human Centric Lighting(H... - HVAC controller Function setting - Controller 1-... Setpoint <li style="background-color: #e0e0e0;">Heating/Cooling control Fan auto.control + Controller 2-... + Controller 3-... + Controller 4-... + Controller 5-... + Controller 6-... + Schedule function - Alarm function Function setting 	<p>Type of heating/cooling control Switching on/off(use 2-point control) ▾</p> <p>Invert control value <input checked="" type="checkbox"/></p> <p>Heating</p> <p>Lower Hysteresis [0..200] <input type="text" value="10"/> *0.1K</p> <p>Upper Hysteresis [0..200] <input type="text" value="10"/> *0.1K</p> <p>Cooling</p> <p>Lower Hysteresis [0..200] <input type="text" value="10"/> *0.1K</p> <p>Upper Hysteresis [0..200] <input type="text" value="10"/> *0.1K</p> <p>Cyclically send control value [0..255] <input type="text" value="10"/> min</p> <hr/> <p>Additional heating/cooling <input checked="" type="checkbox"/></p> <p>Control type <input type="radio"/> 1bit <input checked="" type="radio"/> 1byte</p> <p>Invert control value <input checked="" type="checkbox"/></p> <p>Temperature difference to switch on additional heating [-100..-5] <input type="text" value="-25"/> *0.1K</p> <p>Hysteresis to switch off additional heating [-20..-1] <input type="text" value="-5"/> *0.1K</p> <p>Temperature difference to switch on additional cooling [5..100] <input type="text" value="25"/> *0.1K</p> <p>Hysteresis to switch off additional cooling [1..20] <input type="text" value="5"/> *0.1K</p> <p>Cyclically send control value [0..255] <input type="text" value="0"/> min</p>
-------------------------------------------------------------------------------------------------------------------------------------------------------------------------------------------------------------------------------------------------------------------------------------------------------------------------------------------------------------------------------------------------------------------------------------------------------------------------------------------------------------------------------------------------------------------------------	----------------------------------------------------------------------------------------------------------------------------------------------------------------------------------------------------------------------------------------------------------------------------------------------------------------------------------------------------------------------------------------------------------------------------------------------------------------------------------------------------------------------------------------------------------------------------------------------------------------------------------------------------------------------------------------------------------------------------------------------------------------------------------------------------------------------------------------------------------------------------------------------------------------------------------------------------------------------------------------------------------------------------------------------------------------------------------------------------------------------------------------------------------------------------------------------------------------------------------------------------------------------------------------------------------------------------------------------------------------

Switching on/off(use 2-point control)

1.1.1 KNX Smart Touch S10 > HVAC controller > Controller 1-... > Heating/Cooling control

<ul style="list-style-type: none"> + KNX Scene Internal sensor measureme... Human Centric Lighting(H... - HVAC controller Function setting - Controller 1-... Setpoint Heating/Cooling control Fan auto.control + Controller 2-... + Controller 3-... + Controller 4-... + Controller 5-... + Controller 6-... 	Type of heating/cooling control	Switching PWM(use PI control)	
	Invert control value	<input checked="" type="checkbox"/>	
	PWM cycle time [1..255]	15	min
	Heating speed	Hot water heating(5K/150min)	
	Cooling speed	Cooling ceiling (5K/240min)	
	Cyclically send control value [0..255]	10	min
	Additional heating/cooling	<input checked="" type="checkbox"/>	
	Control type	<input type="radio"/> 1bit <input checked="" type="radio"/> 1byte	
	Invert control value	<input checked="" type="checkbox"/>	
	Temperature difference to switch on additional heating [-100..-5]	-25	*0.1K
	Hysteresis to switch off additional heating [-20..-1]	-5	*0.1K
	Temperature difference to switch on additional cooling [5..100]	25	*0.1K
Hysteresis to switch off additional cooling [1..20]	5	*0.1K	
Cyclically send control value [0..255]	0	min	

Switching PWM(use PI control)

1.1.1 KNX Smart Touch S10 > HVAC controller > Controller 1-... > Heating/Cooling control

+ KNX Scene	Type of heating/cooling control	Continuous control(use PI control)
Internal sensor measureme...	Invert control value	<input checked="" type="checkbox"/>
Human Centric Lighting(H...	Heating speed	Hot water heating(5K/150min)
- HVAC controller	Cooling speed	Cooling ceiling (5K/240min)
Function setting	Send control value on change by [0..100,0=inactive]	5 %
- Controller 1-...	Cyclically send control value [0..255]	10 min
Setpoint	Additional heating/cooling	<input checked="" type="checkbox"/>
Heating/Cooling control	Control type	<input type="radio"/> 1bit <input checked="" type="radio"/> 1byte
Fan auto.control	Invert control value	<input checked="" type="checkbox"/>
+ Controller 2-...	Temperature difference to switch on additional heating [-100..-5]	-25 *0.1K
+ Controller 3-...	Hysteresis to switch off additional heating [-20..-1]	-5 *0.1K
+ Controller 4-...	Temperature difference to switch on additional cooling [5..100]	25 *0.1K
+ Controller 5-...	Hysteresis to switch off additional cooling [1..20]	5 *0.1K
+ Controller 6-...	Cyclically send control value [0..255]	0 min
+ Schedule function		

Continuous control(use PI control)

图 5.3.1.2 “Heating control/Cooling control/Heating/Cooling control”参数设置界面

此界面的参数根据控制模式以及控制系统（2 管或 4 管）显示。

参数 “Type of heating/cooling control”

此参数选择 “Heating and Cooling&2pipe” 时显示, 用于设置加热/制冷功能的控制类型, 不同的控制类型适用于控制不同的温控器。可选项:

Switching on/off(use 2-point control)

Switching PWM(use PI control)

Continuous control(use PI control)

参数 “Invert control value”

此参数设置控制对象是正常发送控制值，还是取反发送控制值，使控制值能适应阀门的类型。

可选项：

No

Yes

Yes：对控制值进行取反后，再通过对象发送到总线上。

以下两个参数适用于两点式控制方式 (2 point control)

参数 "Lower Hysteresis [0...200]"

参数 "Upper Hysteresis [0...200]"

这两个参数设置 RTC 加热或制冷的温度高低滞后值。可选项：**[0...200]*0.1K**

加热状态下，

当实际温度 (T) > 设定温度 + 高滞后值时，停止加热；

当实际温度 (T) < 设定温度 - 低滞后值时，开启加热。

如低滞后值为 1K，高滞后值为 2K，设定温度为 22℃，T 超过 24℃时，停止加热；

如 T 低于 21℃时，开启加热；T 在 21~24℃之间时，维持之前的运行状态。

制冷状态下，

当实际温度 (T) < 设定温度 - 低滞后值时，停止制冷；

当实际温度 (T) > 设定温度 + 高滞后值时，开启制冷。

如低滞后值为 1K，高滞后值为 2K，设定温度为 26℃，T 低于 25℃时，停止制冷；

如 T 高于 28℃时，开启制冷；T 在 28~25℃之间时，维持之前的运行状态。

两点控制方式是一种非常简单的控制方式，采用此种控制方式时，需要通过参数设置上限滞后温度

和下限滞后温度，在设置滞后温度时需要考虑以下影响：

1. 滞后区间较小，温度变化范围也会较小，但频繁地发送控制值会给总线带来较大的负荷；
2. 滞后区间大时，开关切换频率较低，但容易引起不舒适的温度变化。



图 5.3.1.2(2) 两点控制方式下滞后对控制值开关动作的影响（加热）

以下两个参数适用于 PWM 控制方式 (PI control)

参数 “PWM cycle time [1--255]min”

此参数仅在控制类型为“Switching PWM(use PI control)”时可见，用于设置控制对象循环发送开关值的周期，对象根据控制值的占空比发送开关值，例如，假设设置的周期为 10min，控制值为 80%，那么对象将 8min 发送一个开的报文，2min 发送一个关的报文，如此循环，如果控制值改变，对象发送开/关报文的时间占空比也会改变，但周期仍是参数设置的时间。可选项：**1..255**

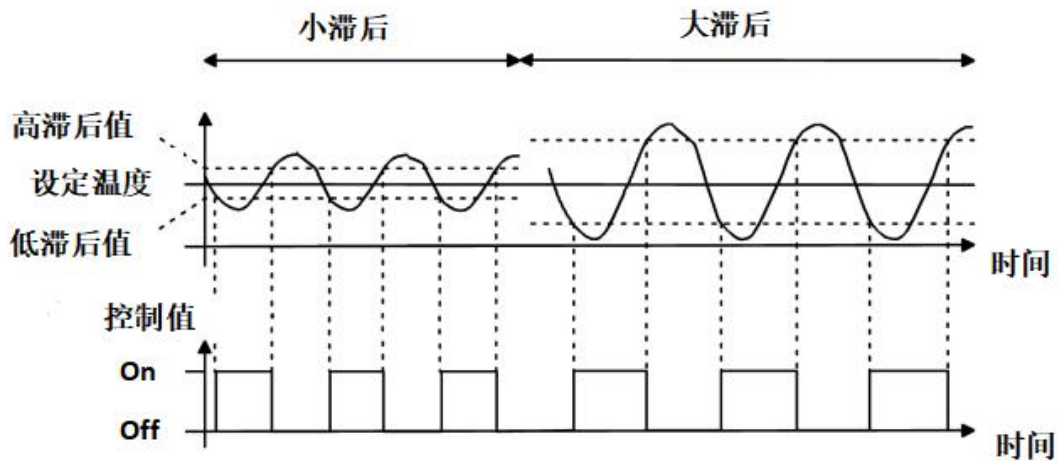
“Switching PWM (use PI control)”和“Continuous control (use PI control)”两种控制类型的PI 控制值是相同的,只是控制对象不同,“Continuous control”的控制对象直接输出PI 控制值(1byte),而“Switching PWM”的控制对象则是根据PI 控制值的占空比来输出一个“on/off”控制报文。

以下两个参数适用于PI 控制方式 (PI control)

参数 “Heating speed”

参数 “Cooling speed”

这两个参数设置加热或制冷PI 控制器的响应速度。不同的响应速度适用于不同的环境。

可选项:

Hot water heating (5K/150min) 热水供暖

Underfloor heating (5K/240 min) 地板供暖

Electrical heating (4K/100min) 电热供暖

Split unit (4K/90min) 分体机

Fan coil unit (4K/90min) 风机盘管

User defined 用户自定义参数

可选项:

Cooling ceiling (5K/240min) 冷却吊顶

Split unit (4K/90min) 分体机

Fan coil unit(4K/90min) 风机盘管

User defined 用户自定义参数

——参数“Proportional range [10..100]*0.1K”

——参数“Reset time [0..255]min”

上一个参数选项为“User defined”时，这两个参数可见。设置 PI 控制器的 PI 值。

可选项：**10..100**

可选项：**0..255**

参数“Send control value on change by [0..100,0=inactive]”

此参数仅在控制类型为“Continuous control (use PI control)”时可见，用于设置控制值改变达到多少时才发送到总线上。可选项：**0..100%**，**0=改变不发送**

PI 控制方式下，加热或制冷系统中各 PI 控制器的预定义控制参数推荐如下：

(1) 加热系统

加热类型	P 参数值	I 参数值（积分时间）	推荐 PI 控制类型	推荐 PWM 循环周期
Hot water Heating	5K	150min	Continuous/PW M	15min
Underfloor heating	5K	240min	PWM	15-20min

Electrical heating	4K	100min	PWM	10-15min
Split unit	4K	90min	PWM	10-15min
Fan coil unit	4K	90min	Continuous	--

(2) 制冷模式

制冷类型	P 参数值	I 参数值 (积分时间)	推荐 PI 控制类型	推荐 PWM 循环周期
Cooling ceiling	5K	240min	PWM	15-20min
Split unit	4K	90min	PWM	10-15min
Fan coil unit	4K	90min	Continuous	--

(3) 用户自定义参数

在参数“Heating/Cooling speed”设置为“User defined”时，可以通过参数设置 P（比例系数）的参数值和 I（积分时间）的参数值。参数调整时参照上表中提及的固定 PI 值进行，即使对控制参数进行很小的调整，也会导致控制行为明显的不同。

此外，积分时间要设置合适，积分时间过大会调节很慢，振荡不明显；积分时间过小会调节很快，但是会出现振荡的现象。0 表示不使用积分项。



图 5.3.1.2(3) PI 控制方式的控制值

Y: 控制值

Y1: 上次的控制值

X1: 温度偏差 = 设定温度—实际温度

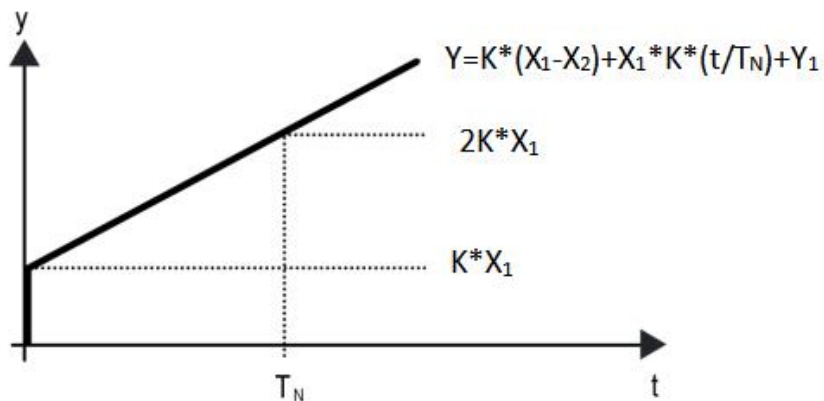
X2: 上一次温度偏差 = 设定温度—实际温度

T_N : 积分时间

K: 比例系数（比例系数不为零）

PI 控制的算法为: $Y=K*(X1-X2) + X1*K*t/T_N+Y1$

当积分时间设置为零时, PI 控制的算法为: $Y=K(X1-X2) + Y2$

用户自定义参数的设置与影响:

参数设置	影响
------	----

K: 比例范围过小	快速调节, 且会出现超调现象
K: 比例范围过大	调节很慢, 但不会出现超调现象
T _N : 积分时间过短	快速调节, 但会出现振荡的现象
T _N : 积分时间过长	调节很慢, 振荡不明显

参数“Cyclically send control value 0...255”

此参数设置循环发送控制值到总线的时间周期。可选项：**0..255min**

参数“Additional heating”

此参数设置是否激活额外的加热阀门控制。

当参数“Additional heating”使能时，以下参数可见。

——参数“Control type”

此参数设置额外加热阀门的控制值对象数据类型。可选项：

1bit

1byte

——参数“Invert control value”

此参数设置控制对象是正常发送控制值，还是取反发送控制值。

对于额外的制热阀门：

——参数“Temperature difference to switch on additional heating

[-100..-5]*0.1K”

此参数设置开启额外加热阀门的温差区间，当环境温度 < (设定温度+开机温差)，则开启额外加热阀门。可选项：-100...-5

——参数“Hysteresis to switch off additional heating [-20..-1]*0.1K”

此参数设置关闭额外加热阀门的滞回区间，当环境温度 > (设定温度+开机温差-滞回区间)，则关闭额外加热阀门。可选项：-20... -1

注意：制热的温差值和滞后值必须符合 $|\text{滞后值}| < |\text{温差值}|$ ，如果不符合这一条件，ETS 上的参数将不能设置，且会显示红色框警告，如下所示：

Temperature difference to switch on additional heating [-100..-5]	<input type="text" value="-9"/>	*0.1K
Hysteresis to switch off additional heating [-20..-1]	<input type="text" value="-10"/>	*0.1K

对于额外的制冷阀门：

——参数“Temperature difference to switch on additional cooling

[5..100]*0.1K”

此参数设置开启额外制冷阀门的温差区间，当环境温度 > (设定温度+开机温差)，则开启额外制冷阀门。可选项：5...100

——参数“Hysteresis to switch off additional cooling [1..20]*0.1K”

此参数设置关闭额外加热阀门的滞回区间，当环境温度 < (设定温度+开机温差-滞回区间)，则关闭额外制冷阀门。可选项：1...20

注意：制冷的温差值和滞后值必须符合 $|\text{滞后值}| < |\text{温差值}|$ ，如果不符合这一条件，ETS 上的参

数将不能设置，且会显示红色框警告，如下所示：

Temperature difference to switch on additional cooling [5..100]	<input type="text" value="19"/>	*0.1K
Hysteresis to switch off additional cooling [1..20]	<input type="text" value="20"/>	*0.1K

——参数“Cyclically send control value [0..255]min”

此参数设置循环发送控制值到总线的时间周期。可选项：**0…255**

5.3.1.3 设置参数界面 “Fan auto.control”

此界面在控制器类型选择“Room temperature controller (RTC)”且自动风速使能可见，如图

5.3.1.3 所示。

1.1.1 KNX Smart Touch S10 > HVAC controller > Controller 1-... > Fan auto.control

The screenshot displays the configuration page for 'Fan auto.control'. On the left is a navigation menu with options like 'KNX Secure', 'General', 'Home page', 'Display view', 'KNX Channel', 'KNX Scene', 'Scene 1-...', 'Internal sensor measureme...', 'Human Centric Lighting(H...', 'HVAC controller', 'Function setting', 'Controller 1-...', 'Setpoint', 'Heating/Cooling control', 'Fan auto.control', 'Controller 2-...', 'Controller 3-...', 'Controller 4-...', and 'Controller 4-...'. The main area contains the following settings:

- Auto. operation on object value:** Radio buttons for 'Auto=1/Man.=0' (selected) and 'Auto=0/Man.=1'.
- Fan speed output setting:**
 - Object datatype of 1byte fan speed: Radio buttons for 'Fan stage (DPT_5.100)' and 'Percentage (DPT_5.001)' (selected).
 - Output value for fan speed low: 33 %
 - Output value for fan speed medium: 67 %
 - Output value for fan speed high: 100 %
 - 1 bit object function for fan speed:
- Fan speed control setting:**
 - Condition setting for using PI control:
 - Threshold value speed OFF<-->low [1..255]: 80
 - Threshold value speed low<-->medium [1..255]: 150
 - Threshold value speed medium<-->high [1..255]: 200
 - Hysteresis threshold value in +/- [0..50]: 10
 - Condition setting for using 2-point control:
 - Temperature difference speed OFF<-->low [1..200]: 20 *0.1K
 - Temperature difference speed low<-->medium [1..200]: 30 *0.1K
 - Temperature difference speed medium<-->high [1..200]: 40 *0.1K
 - Hysteresis temperature difference in [0..50]: 10 *0.1K
 - Minimum time in fan speed [0..65535]: 60 s

图 5.3.1.3 “Fan”参数设置界面

参数“Auto. operation on object value”

此参数用于激活自动操作的报文值。可选项：

Auto=1/Man.=0

Auto=0/Man.=1

Auto=1/Man.=0：当对象“Fan automatic operation”接收到报文值“1”时，激活自动操作；收到“0”时，自动操作改为手动操作；

Auto=0/Man.=1：当对象“Fan automatic operation”接收到报文值“0”时，激活自动操作；收到“1”时，自动操作改为手动操作。

上电复位后，自动操作默认是未激活状态。

Fan speed output setting 风速输出值

参数“Object datatype of 1byte fan speed”

此参数设置 1byte 风速的对象数据类型。可选项：

Percentage (DPT_5.001)

Fan stage (DPT_5.100)

——参数“Output value for fan speed low/medium/high”

此三个参数定义切换到各个风速所发送的值。当报文值为 0 时，风速关。

根据风速对象类型可选项：**1..255 / 1..100%**

注意：1byte 风速的输出值和状态反馈值必须符合低<中<高，如果不符合这一条件，ETS 上的参

数将不能设置，且会显示红色框警告，如下所示：

Output value for fan speed low	<input type="text" value="3"/>
Output value for fan speed medium	<input type="text" value="2"/>
Output value for fan speed high	<input type="text" value="3"/>

参数“1 bit object function for fan speed”

此参数设置是否使能风速的 1bit 对象控制功能。使能时，各风速的 1bit 控制对象可见。

——参数“1 bit object for fan speed off”

上一个参数使能时，此参数可见。设置是否使能风速关的 1bit 对象可见。

Fan speed control setting 风速控制设置

Condition setting for using PI control 采用 PI 控制方式时风速转换的条件设置

使用 PI 控制方式的情况下，控制值由程序内部进行 PI 运算，控制器会根据控制值所在的阈值范围进行风机的开关或切换风速。

参数“Threshold value speed OFF<-->low [1..255]”

此参数定义关风机和低档风速的阈值。可选项：**1..255**

如果控制值大于或等于该参数设置的阈值，则运行低档风速；如果控制值小于这个阈值，则关掉风机。

参数“Threshold value speed low<-->medium [1..255]”

此参数定义把风速切换到中档风速的阈值。如果控制值大于或等于该参数设置的阈值，则运行中档风速。可选项：**1..255**

参数“Threshold value speed medium<->high [1..255]”

此参数定义把风速切换到高档风速的阈值。如果控制值大于或等于该参数设置的阈值，则运行高档风速。可选项：**1..255**

提示：控制器以升序的方式评估阈值。

首先需检查→OFF <->低风速的阈值 →低风速<->中风速 →中风速 <->高风速。

功能执行的正确性仅在此种情况下得到保证：

OFF <->低风速的阈值小于低风速 <->中风速的阈值，低风速 <->中风速的阈值小于中风速 <->高风速的阈值。

参数“Hysteresis threshold value in +/-[0..50]”

此参数设置阈值的滞后值，滞后可避免控制值在阈值附近波动时引起风机不必要的动作。可选项：

0..50

如果是 0，则没有滞后，控制值一旦大于阈值，风机将立即切换风速；

假设滞后值为 10，阈值为 50，那么将会有上限阈值 60（阈值+滞后值），下限阈值 40（阈值-滞后值），那么当控制值处于 40~60 之间时，将不会引起风机的动作，仍维持之前的状态。只有小于 40 或大于(或等于)60 才会使风机的运行状态改变。

Condition setting for using 2-point control 采用两点式开关控制方式时风速转换的条件设置

使用 2-point 控制方式的情况下，控制器根据实际温度和设定温度的温差来决定风机的开关或风速。

制冷下：温差 = 实际温度 - 设定温度；

制热下：温差 = 设定温度 - 实际温度。

参数“Temperature difference speed OFF<-->low[1..200]*0.1K”

此参数定义关风机和低档风速的温差值。可选项：**[1..200]*0.1**

如果温差大于或等于该参数设置的温差，则运行低档转速；如果小于这个温差，则关掉风机。

参数“Temperature difference speed low<-->medium [1..200]*0.1K”

此参数定义把风速切换到中档风速的阈值。如果温差大于或等于该参数设置的温差值，则运行中档风速。可选项：**1..200**

参数“Temperature difference speed medium<-->high [1..200]*0.1K”

此参数定义把风速切换到高档风速的温差值。如果温差大于或等于该参数设置的温差值，则运行高档风速。可选项：**1..200**

参数“Hysteresis temperature difference in [0..50] *0.1K”

此参数设置温差的滞后值，滞后可避免控制值在阈值附近波动时引起风机不必要的动作。可选项：

0..50

如果是 0，则没有滞后，温差一旦大于定义的温差值，风机将立即切换风速；

假设滞后值为 0.5℃，定义的温差值为 1℃，那么将会有上限温差值 1.5℃（定义温差值+滞后值），下限温差值 0.5℃（定义温差值-滞后值），那么当温差处于 0.5℃~1.5℃之间时，将不会引起风机的动作，仍维持之前的状态。只有小于 0.5℃或大于(或等于)1.5℃才会使风机的运行状态改变。

参数“Minimum time in fan speed [0..65535]”

此参数定义风机从当前风速切换至更高风速或更低风速之前的停留时间，也就是一个风速运行的最小时间。

如需切换至另外风速，需等这段时间之后，才可进行切换。

如当前风速已运行足够长时间，风速变换时可迅速切换。可选项：**0..65535**

0：表示无最小运行时间，但仍需考虑风速的延时切换时间。

注意：此参数设置的停留时间仅在自动模式下启用。

5.3.2 参数设置界面 “Cotroller x-Ventilation controller”(x=1~6)

控制类型选择新风时可见,实现风速的自动控制,与 PM2.5 或 CO2, VOC 检测值做风速联动控制,,

如图 5.3.2 所示。

1.1.1 KNX Smart Touch S10 > HVAC controller > Controller 1-...

<ul style="list-style-type: none"> KNX Secure General Home page Display view KNX Channel KNX Scene Scene 1-... Internal sensor measureme... Human Centric Lighting(H... HVAC controller Function setting Controller 1-... Controller 2-... Controller 3-... Controller 4-... Controller 5-... Controller 6-... Schedule function 	<p>Description (max 30char.)</p> <p>Controller type</p> <p>Auto.operation on object value</p> <p>State of Auto.operation after startup</p> <hr/> <p>Fan speed output setting</p> <p>Object datatype of 1byte fan speed</p> <p>Output value for fan speed low</p> <p>Output value for fan speed medium</p> <p>Output value for fan speed high</p> <hr/> <p>Fan speed control setting</p> <p>Control value reference from</p> <p>Object datatype of PM2.5</p> <p>Period for request control value [0..255,0=inactive]</p> <p>The fan speed status when the control value error</p> <p>Threshold value OFF<-->speed low [1..999]</p> <p>Threshold value speed low<-->medium [1..999]</p> <p>Threshold value speed medium<-->high [1..999]</p>	<p><input type="text"/></p> <p><input type="radio"/> Room temperature controller (RTC)</p> <p><input checked="" type="radio"/> Ventilation controller</p> <p><input checked="" type="radio"/> Auto=1/Man.=0 <input type="radio"/> Auto=0/Man.=1</p> <p><input checked="" type="radio"/> Disable <input type="radio"/> Enable</p> <hr/> <p><input type="radio"/> Fan stage (DPT_5.100)</p> <p><input checked="" type="radio"/> Percentage (DPT_5.001)</p> <p><input type="text" value="33"/> %</p> <p><input type="text" value="67"/> %</p> <p><input type="text" value="100"/> %</p> <hr/> <p>PM2.5</p> <p><input checked="" type="radio"/> Value in ug/m3(DPT_7.001)</p> <p><input type="radio"/> Float value in ug/m3(DPT_9.030)</p> <p><input type="text" value="10"/> min</p> <p>OFF</p> <p><input type="text" value="35"/></p> <p><input type="text" value="75"/></p> <p><input type="text" value="115"/></p>
-----------------------------------------------------------------------------------------------------------------------------------------------------------------------------------------------------------------------------------------------------------------------------------------------------------------------------------------------------------------------------------------------------------------------------------------------------------------------------------------------------------------	----------------------------------------------------------------------------------------------------------------------------------------------------------------------------------------------------------------------------------------------------------------------------------------------------------------------------------------------------------------------------------------------------------------------------------------------------------------------------------------------------------------------------------------------------------------------------------------------------------------------------------------------------------------------------------------------------------------------------------------------------------------------------	--------------------------------------------------------------------------------------------------------------------------------------------------------------------------------------------------------------------------------------------------------------------------------------------------------------------------------------------------------------------------------------------------------------------------------------------------------------------------------------------------------------------------------------------------------------------------------------------------------------------------------------------------------------------------------------------------------------------------------------------------------------------------------------------------------------------------------------------------------------------------------------------------------------------

图 5.3.2 “Cotroller x-Ventilation controller”(x=1~6)参数设置界面

参数“Auto. operation on object value”

此参数用于激活自动操作的报文值。可选项：

Auto=1/Man.=0

Auto=0/Man.=1

Auto=1/Man.=0：当对象“Fan automatic operation”接收到报文值“1”时，激活自动操作；收到“0”时，自动操作改为手动操作；

Auto=0/Man.=1：当对象“Fan automatic operation”接收到报文值“0”时，激活自动操作；收到“1”时，自动操作改为手动操作。

上电复位后，自动操作默认是未激活状态。

参数“State of Auto operation after startup”

此参数用于设备启动时，是否启用自动操作。可选项：

Disable

Enable

Fan speed output setting 风速输出设置**参数“Object datatype of 1byte fan speed”**

此参数设置 1byte 风速的对象数据类型。可选项：

Percentage (DPT_5.001)

Fan stage (DPT_5.100)

——参数“Output value for fan speed low/medium/high”

这三个参数定义切换到各个风速所发送的值。当报文值为 0 时，风速关。

根据风速对象类型可选项：**1..255 / 1..100%**

Fan speed control setting 风速控制设置

参数“Control value reference from”

此参数设置自动操作的控制值来源。可选项：

PM2.5

CO2

VOC

参数“Object datatype of PM2.5/VOC”

这两个参数设置 PM2.5 或者 VOC 的数据类型。数据类型决定了对象类型，根据对接的 PM2.5 或

VOC 传感器数据类型选择。可选项：

Value in ug/m3(DPT 7.001)

Float value in ug/m3(DPT 9.030)

DPT_7.001：适用整形数值。

DPT_9.030：适用浮点型数值。

参数“Object datatype of CO2”

此参数设置 CO2 的数据类型。数据类型决定了对象类型，根据对接的 CO2 传感器数据类型选择。

可选项：

Value in ppm(DPT 7.001)

Float value in ppm(DPT 9.008)

DPT_7.001：适用整形数值。

DPT_9.008：适用浮点型数值。

参数“Period for request control value [0...255,0=inactive]min”

此参数设置设备在总线复位或编程完成后，向外部传感器发送控制值读请求的时间周期。可选项：

0..255

参数“The fan speed status when the control value error”

此参数设置当控制值发生错误时，新风默认开启的风速。可选项：

Off

Low

Medium

High

参数“Threshold value OFF<-->speed low [1..999]/ [1...4000]”

此参数定义关风机和低档风速的阈值。可选项：**1..999/1..4000**

如果控制值大于或等于该参数设置的阈值，则运行低档风速；如果控制值小于这个阈值，则关掉风机。

参数“Threshold value speed low<-->medium [1..999]/ [1...4000]”

此参数定义把风速切换到中档风速的阈值。如果控制值大于或等于该参数设置的阈值，则运行中档风

速。可选项：**1..999/1..4000**

参数“Threshold value speed medium<-->high [1..999]/ [1...4000]”

此参数定义把风速切换到高档风速的阈值。如果控制值大于或等于该参数设置的阈值，则运行高档风

速。可选项：**1..999/1..4000**

提示：控制器以升序的方式评估阈值。

首先需检查→OFF <-> 低风速的阈值 →低风速<->中风速 →中风速 <-> 高风速。

功能执行的正确性仅在此种情况下得到保证：

OFF <-> 低风速的阈值小于低风速 <-> 中风的阈值, 低风速 <-> 中风的阈值小于中风的

<-> 高风速的阈值。

参数“Hysteresis value is threshold in +/- [10..30]/[100..400]”

此参数设置阈值的滞后值, 滞后可避免控制值在阈值附近波动时引起风机不必要的动作。

可选项: **10..30/100..400**

例如控制值为 CO₂, 滞后值为 100, 阈值为 450, 则上限阈值 550 (阈值+滞后值), 下限阈值 350 (阈值-滞后值), 当控制值处于 350~550 之间, 不会引起风机的动作, 仍维持之前的状态。只有小于 350 或大于等于 550 才会使风机的运行状态改变。如下图:

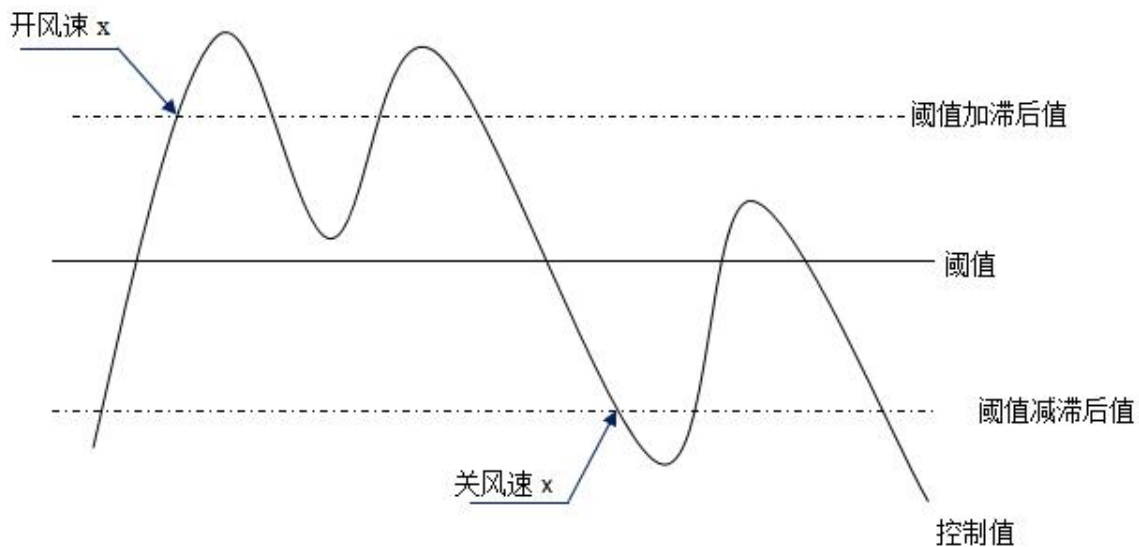

注:

启用滞后的状态下, 如出现阈值重叠, 风机的动作规定如下:

- 1) 滞后决定风速转换发生的控制点;
- 2) 如风速转换发生, 新的风速由控制值和阈值决定, 无需考虑滞后。

例如 (1) :

PM2.5 为例

OFF <-> 低风速的阈值为 35

低风速 <-> 中风速的阈值为 55

中风速 <-> 高风速的阈值为 75

滞后是 25

风机的风速从 **OFF** 上升时的行为:

风机 **OFF** 状态将在控制值为 **60** ($\geq 25 + 35$) 转变, 新的风速将是中风速 (因为 **60** 在 **55** 和 **75** 之间, 此时无需考虑滞后), 因此低风速是被忽略的;

风机的风速从高风速下降时的行为:

风机的高风速将在控制值为 **50** ($< 75 - 25$) 转变, 新的风速将是低风速 (因为 **50** 在 **35** 和 **55** 之间, 此时无需考虑滞后), 因此中风速是被忽略的。

例如 (2) :

PM2.5 为例

OFF <-> 低风速的阈值为 20

低风速 <-> 中风速的阈值为 40

中风速 <-> 高风速的阈值为 70

滞后是 10

风机的风速从 **OFF** 上升时的行为:

风机 **OFF** 状态将在控制值为 **30** ($\geq 20 + 10$) 转变。

如收到的控制值为 **41**，新的风速将是中风速（因为 **41** 在 **40** 和 **70** 之间，此时无需考虑滞后），

因此低风速是被忽略了的；

如收到的控制值为 **39**，新的风速将是低风速（因为 **39** 在 **20** 和 **40** 之间，此时无需考虑滞后）。

风机的风速从高速下降时的行为：

风机的高速将在控制值为 **60**（ $<70-10$ ）转变。

如收到的控制值为 **39**，新的风速将是低风速（因为 **39** 在 **20** 和 **40** 之间，此时无需考虑滞后），

因此中风速是被忽略的。

3) 无论什么情况，控制值为 **0**，风机将关掉；

参数“Minimum time in fan speed [0..65535]s”

此参数定义风机从当前风速切换至更高风速或更低风速之前的停留时间，也就是一个风速运行的最小

时间。可选项：**0..65535**

如需切换至另外风速，需等这段时间之后，才可进行切换。

如当前风速已运行足够长时间，风速变换时可迅速切换。

0：表示无最小运行时间，但仍需考虑风速的延时切换时间。

注意：此参数设置的停留时间仅在自动模式下启用。

5.4 参数设置界面 “Human Centric Lighting(HCL)”

该界面在图 5.2.8“Advanced setting”中的参数“Human Centric Lighting(HCL)”选择使能时可见，如图 5.4 所示，这里主要根据设定的时间自动调整亮度和色温。

1.1.1 KNX Smart Touch S10 > Human Centric Lighting(HCL)

<ul style="list-style-type: none"> KNX Secure General <ul style="list-style-type: none"> General setting Security setting Night mode setting Coordinates location setting Summer time setting Proximity setting Advanced setting Home page Display view KNX Channel KNX Scene Internal sensor measureme... Human Centric Lighting(...) HVAC controller <ul style="list-style-type: none"> Function setting Controller 1-... 	<p>Switching time <input checked="" type="radio"/> Depend to certain time <input type="radio"/> Depend to sunrise&sunset</p> <p>HCL behavior after voltage recovery Stop running</p> <p>HCL behavior at receiving switch control telegram "Off" <input checked="" type="radio"/> Ignore, and keep running <input type="radio"/> Stop running</p> <p>HCL behavior at receiving other control telegram from bus Ignore, and keep running</p> <p>Colour temperature control type <input checked="" type="radio"/> Normal <input type="radio"/> Directly(with warm/cool white algorithm)</p> <p>Control brightness via HCL <input checked="" type="radio"/> Disable <input type="radio"/> Enable</p> <hr/> <p>Time 1 <input checked="" type="checkbox"/></p> <p>Time 06:00</p> <p>Colour temperature preset 2700 K</p> <p>Time 2 <input checked="" type="checkbox"/></p> <p>Time 08:00</p> <p>Colour temperature preset 4000 K</p> <p>Time 3 <input checked="" type="checkbox"/></p> <p>Time 10:00</p> <p>Colour temperature preset 5000 K</p> <p>Time 4 <input checked="" type="checkbox"/></p> <p>Time 12:00</p> <p>Colour temperature preset 6500 K</p> <p>Time 5 <input checked="" type="checkbox"/></p>
----------------------------------------------------------------------------------------------------------------------------------------------------------------------------------------------------------------------------------------------------------------------------------------------------------------------------------------------------------------------------------------------------------------------------------------------------------------------------------------------------------------------------------------------------------------------------------------------------------------------------------------------	----------------------------------------------------------------------------------------------------------------------------------------------------------------------------------------------------------------------------------------------------------------------------------------------------------------------------------------------------------------------------------------------------------------------------------------------------------------------------------------------------------------------------------------------------------------------------------------------------------------------------------------------------------------------------------------------------------------------------------------------------------------------------------------------------------------------------------------------------------------------------------------------------------------------------------------------------------------------------------------------------------------------------------------------------------------------------------------------------------------------------------------------------------------------------------------------------------------------------------

“Human Centric Lighting(HCL)-Depend to certain time

1.1.1 KNX Smart Touch S10 > Human Centric Lighting(HCL)

<ul style="list-style-type: none"> KNX Secure General <ul style="list-style-type: none"> General setting Security setting Night mode setting Coordinates location setting Summer time setting Proximity setting Advanced setting Home page Display view KNX Channel KNX Scene Internal sensor measureme... Human Centric Lighting(...) HVAC controller <ul style="list-style-type: none"> Function setting Controller 1-... 	<p>Switching time</p> <p>HCL behavior after voltage recovery</p> <p>HCL behavior at receiving switch control telegram "Off"</p> <p>HCL behavior at receiving other control telegram from bus</p> <p>Colour temperature control type</p> <hr/> <p>Time 1 <input checked="" type="checkbox"/></p> <p>Time</p> <p>Colour temperature preset</p> <p>Brightness preset</p> <p>Time 2 <input checked="" type="checkbox"/></p> <p>Time</p> <p>Colour temperature preset</p> <p>Brightness preset</p> <p>Time 3 <input checked="" type="checkbox"/></p> <p>Time</p> <p>Colour temperature preset</p> <p>Brightness preset</p> <p>Time 4 <input checked="" type="checkbox"/></p> <p>Time</p>	<p><input type="radio"/> Depend to certain time</p> <p><input checked="" type="radio"/> Depend to sunrise&sunset</p> <p>Stop running</p> <p><input type="radio"/> Ignore, and keep running <input checked="" type="radio"/> Stop running</p> <p>Ignore, and keep running</p> <p><input type="radio"/> Normal</p> <p><input checked="" type="radio"/> Directly(with warm/cool white algorithm)</p> <p>Sunrise +-0min</p> <p>2700 K</p> <p>50 %</p> <p>Sunrise +2h</p> <p>4000 K</p> <p>100 %</p> <p>Sunrise +4h</p> <p>5000 K</p> <p>100 %</p> <p>Sunrise +5h</p>
----------------------------------------------------------------------------------------------------------------------------------------------------------------------------------------------------------------------------------------------------------------------------------------------------------------------------------------------------------------------------------------------------------------------------------------------------------------------------------------------------------------------------------------------------------------------------------------------------------------------------------------------	-------------------------------------------------------------------------------------------------------------------------------------------------------------------------------------------------------------------------------------------------------------------------------------------------------------------------------------------------------------------------------------------------------------------------------------------------------------------------------------------------------------------------------------------------------------------------------------------------------------------------------------------------------------------------------------	----------------------------------------------------------------------------------------------------------------------------------------------------------------------------------------------------------------------------------------------------------------------------------------------------------------------------------------------------------------------------------------------------------------------------------------------------------------------------------------------------------------------------------------------------------------------

“Human Centric Lighting(HCL)-Depend to sunrise&sunset”

图 5.4 “Human Centric Lighting(HCL)”参数设置界面

参数“Switching time”

此参数设置切换时间的方式。可选项：

Depend to certain time

基于固定时间

Depend to sunrise&sunset

基于日出日落

参数“HCL behavior after voltage recovery”

此参数设置掉电恢复后，HCL 的运行动作。可选项：

Start running	启动运行
Stop running	停止运行
As before voltage failure	掉电前的运行状态

参数“HCL behavior at receiving switch control telegram "Off"”

此参数设置在 HCL 运行中接收到总线开关控制报文 Off 时 HCL 的运行动作。可选项：

- Ignore, and keep running**
- Stop running**

Ignore, and keep running: 忽略且继续运行，不显示对象 Switch control;

Stop running: 停止 HCL 运行。

参数“HCL behavior at receiving other control telegram from bus”

此参数设置在 HCL 运行中接收到总线控制报文时 HCL 的动作。可选项：

- Ignore, and keep running**
- Ignore, but stop running**
- Update preset value, and keep running**
- Update preset value, and stop running**

Ignore, and keep running: 忽略接收的报文，继续 HCL 运行；

Ignore, but stop running: 忽略接收的报文，但 HCL 停止运行；

Update preset value, and keep running: 接收到亮度或色温控制报文时，更新当前的亮度或色温值，继续 HCL 运行；

Update preset value, and stop running: 接收到亮度或色温控制报文时, 更新当前的亮度或色温值, 停止 HCL 运行。

注: 在该时间段接收的报文, 则更新该时间段的参数预设值。HCL 停止运行期间, 不记录。已更新的预设值掉电会保存。

参数“Colour temperature control type”

此参数设置色温的控制类型。可选项:

Normal 普通控制

Directly(with warm/cool white algorithm) 直接控制 (使用暖/冷白算法)

Normal: 发出 1byte 亮度和 2byte 色温值;

Directly(with warm/cool white algorithm): 直接控制, 设备已内置了“亮度值+色温值”与暖/冷白灯亮度的转换算法, 即 2 个 1byte 对象, 用于输出控制暖白灯和冷白灯的亮度调节。

——参数“Control brightness via HCL”

上一个参数选择“Normal”时, 此参数可见。设置是否通过 HCL 控制亮度。

以下参数预设每个时间段的亮度值和色温值, 最多可以设置 **10** 个时间段。

参数“Time X(X=1-10)”

使能时, 以下三个参数可见。此参数设置是否使能时间段 x。

——参数“Time”

此参数设置预设的时间段, 选项根据切换时间的方式不同。

选择“Depend to certain time”，可选项：

00:00

01:00

02:00

...

23:00

选择“Depend to sunrise&sunset”，可选项：

Sunrise -5h

Sunset +-0min

Sunrise -4h

Sunset +30min

...

Sunset +1h

Sunrise -1h

...

Sunrise -30min

Sunset +4h

Sunrise +-0min

Sunset +5h

...

——参数“Colour temperature preset”

此参数设置预设的色温值。可选项：**2000..7000K**

——参数“Brightness preset”

色温的控制类型选择“Normal”且参数“Control brightness via HCL”使能时，或者选择

“Directly(with warm/cool white algorithm)”时，此参数可见。设置预设的亮度值。可选项：

0%

5%

10%

...

95%

100%

5.5 参数设置界面 “Schedule function”

该界面在图 5.2.8“Advanced setting”中的参数“Schedule function”选择使能时可见，如图 5.5 所示，最多可使能 16 个定时功能。



图 5.5 “Schedule function”参数设置界面

参数“Number of schedules (max.16)”

此参数设置使能定时功能的数量。可选项：**1....16**

5.5.1 参数设置界面 “Schedule X”

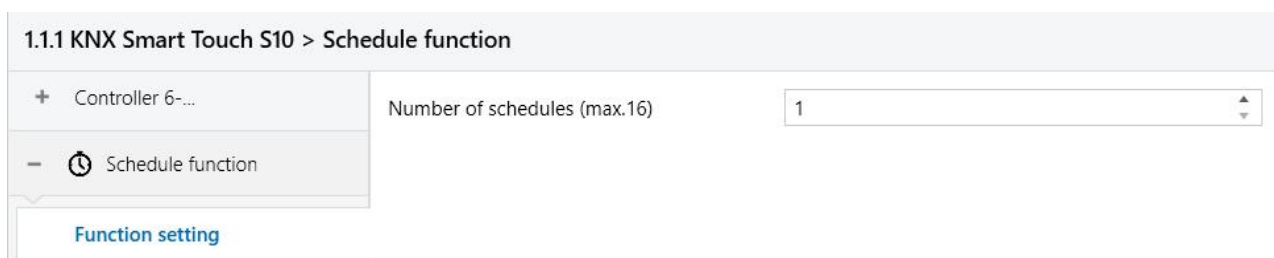
1.1.1 KNX Smart Touch S10 > Schedule function > Schedule 1-...

+ Controller 6-...	Description for schedule	<input type="text"/>
- ⌚ Schedule function	Overwrite the schedule setting during download	<input type="checkbox"/>
Function setting	Object type of schedule	1byte
Schedule 1-...	Object datatype	1byte unsigned value
- ⚠ Alarm function	Output value[0..255]	127
Function setting	Schedule disable function	Disable
Alarm 1-...	Schedule configuration	
- ⏸ Input function	Day	Monday
Function setting	Enable	<input type="checkbox"/>
		<input type="checkbox"/>
		<input type="checkbox"/>
		<input type="checkbox"/>
		<input type="checkbox"/>
		<input type="checkbox"/>
		<input type="checkbox"/>
		<input type="checkbox"/>
	Time	23:59 hh:mm

图 5.5.1 “Schedule X”参数设置界面

参数“Description for schedule function”

此参数设置定时 x 的名称，最多可输入 18 个字符（汉字最多支持 6 个）。

参数“Overwrite the schedule function setting during download”

此参数设置数据库下载期间是否覆盖周定时功能。

如果选择覆盖，则数据库下载后，屏上的周定时器功能就以数据库配置为准。

如果不覆盖，则如果原先该通道已经有激活了，那么数据库配置就不会传到屏上，如果原先该通道未激活，那么屏上该通道的定时配置也会以数据库为准。

参数“Object type of schedulefunction”

此参数设置定时 x 的定时时间到了所发送值的数据类型。可选项：

1bit

1byte

2byte**——参数“Object datatype”**

此参数用于定义 1byte 或者 2byte 的数据类型。

1byte 时，可选项：

1byte unsigned value

1byte[scene control]

HVAC mode

2byte 时，可选项：

2byte unsigned value

Temperature value

——参数“Output value/ scene No.[...]”

此参数设置定时 x 的定时时间到了所发送的报文值。可设置的值范围由数据类型决定。

参数“schedule disable function”

此参数用于设置是否可通过对象禁用或使能定时功能，或者设置禁用/使能定时的触发值。可选项：

Disable 不能通过对象禁止或使能定时功能

Disable=0/Enable=1 0 禁止定时，1 使能定时

Disable=1/Enable=0 1 禁止定时，0 使能定时

以下参数设置定时 x 的时间点，当时间点到了，执行定时 x 的动作。

参数“Monday/Tuesday/Wednesday/Thursday/Friday/Saturday/Sunday”

此参数用于配置一周中某一天使能定时 x。

参数“Time”

此参数用于配置定时 x 的具体时间点。可选项：

时： **0..23**

分： **0..59**

注：设备内部 RTC 实时时钟的精度为±20 ppm。

5.6 参数设置界面 “Alarm function”

该界面在图 5.2.8“Advanced setting”中的参数“Alarm function”选择使能时可见,如图 5.6 所示,最多可设置 24 个报警信号。



图 5.6 “Alarm function”参数设置界面

参数“Max. duration of acoustic alarm signal”

此参数设置报警音的播放周期。每次有接收到激活报警的报文则立刻播放，如果当前处于播放中则不会被中断且不会重新计时；如果播放中接收到取消报警的报文则马上中断播放。可选项：

Disable

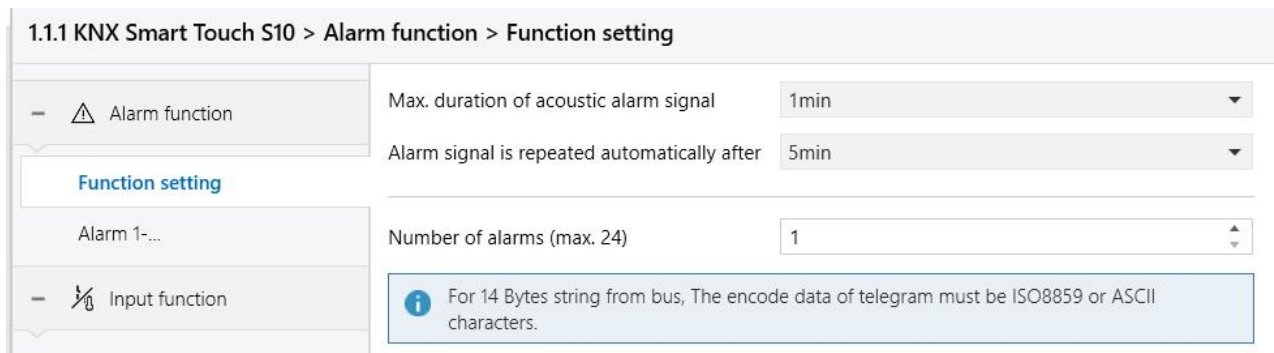
10s

20s

...

25min

30min

Disable: 不使能报警音播放功能;

其他选项: 报警音的播放时长。

参数 "Alarm signal is repeated automatically after "

此参数设置报警音自动重复的间隔时间, 计时只跟上一次播放结束的节点有关。可选项:

Disable

10s

20s

...

25min

30min

Disable: 不使能报警音重复功能;

其他选项: 报警音播放结束后延时所设定的时间后再自动播放。

参数 "Number of alarms (max.24) "

此参数设置使能的警报数量。可选项: **1...24**

 The encode data of telegram must be ISO8859 or ASCII characters

警告报文的字符编码与界面语言有关联, 当选择中文简体、中文繁体、俄语或者希腊语时, 采用 **UTF-8**;

选择其他的语言则均采用 ISO8859。

5.6.1 设置参数界面 “Alarm x”(x=1~24)

参数设置界面“Alarm x”(x=1~24)，如图 5.6.1 所示，这里主要设置报警功能。



图 5.6.1 “Alarm x”(x=1~24) 参数设置界面

参数“Description for alarm”

此参数设置警报 x 的名称，最多可输入 18 个字符（汉字最多支持 6 个）。

参数“When alarm active, warning message via”

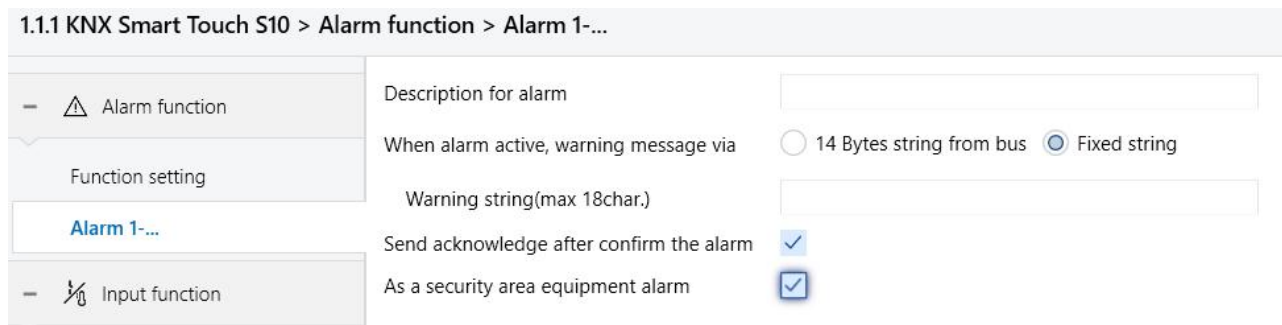
当警报激活时，此参数设置警报信息的输入方式，可以选择屏上显示 ETS 输入的固定字符或者由总

线接收 14byte 字符串。可选项：

Fixed string**14 Bytes string from bus****——参数“Warning string(max 18char.)”**

当上一个参数选择“Fixed string”时，此参数可见。用于当警报激活时，设置指示的文本信息。

参数“Send acknowledge after confirm the alarm ”

此参数设置是否发送 1bit 应答报文，该动作是当用户点击屏上确认警报信息后才需处理的。

参数“As a security area equipment alarm ”

此参数设置是否作为安防防区设备警报。

如果是，则在设备端报警设置的防区设备列表中显示该设备。

如果不是，则作为普通警报。

5.7 参数设置界面 “Logic function”

该界面在图 5.2.8“Advanced setting”中的参数“Logic function”选择使能时可见，如图 5.7 所示，

用于使能逻辑功能，最多 8 个逻辑功能可供设置。





图 5.7 “Logic function”参数设置界面

参数“1st/2nd/3rd... Logic function”

此参数设置逻辑对应的设置界面，选择后显示对应的逻辑功能页。最多可以使能 8 个逻辑功能。

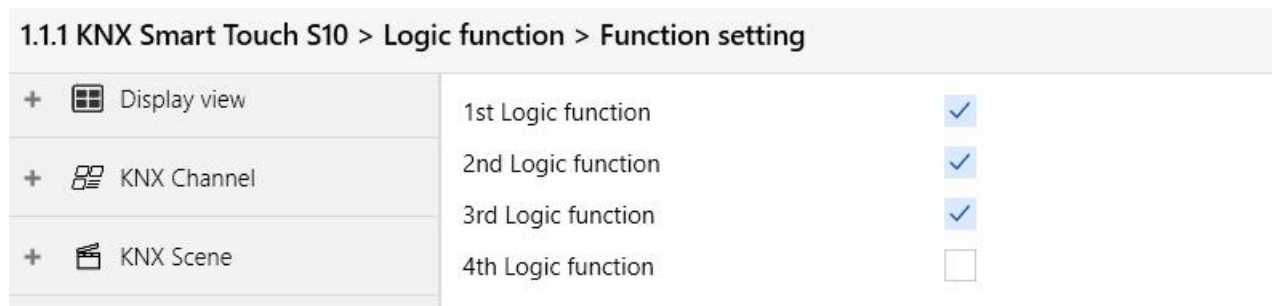
参数“Description for logic function”

此参数设置当前逻辑功能的名称描述。最多可输入 30 个字符。

参数“Function of channel”

此参数设置该通道的逻辑功能。可选项：

AND 与运算

OR 或运算

XOR 异或运算

Gate forwarding 逻辑门转发

Threshold comparator 阈值比较器

Format convert 格式转换

Gate function 门函数

Delay function 延迟功能

Staircase lighting 楼梯照明

AND/OR/XOR: 参数和通讯对象相似, 仅逻辑算法不同, 下面将以其中一个选项的参数为例进行说明。

5.7.1 “AND/OR/XOR”功能参数

1.1.1 KNX Smart Touch S10 > Logic function > 1st Logic function-...

+ General	Description for logic function	<input type="text"/>
Home page	Function of channel	AND ▼

1.1.1 KNX Smart Touch S10 > Logic function > 1st Logic function-...

<ul style="list-style-type: none"> + General Home page + Display view + KNX Channel + KNX Scene Internal sensor measureme... Human Centric Lighting(H... + HVAC controller + Schedule function + Alarm function + Input function - Logic function Function setting <li style="background-color: #e0e0e0;">1st Logic function-... - Scene group function Function setting - Group 1 	Input b	Disconnected ▼
	Default value	<input checked="" type="radio"/> 0 <input type="radio"/> 1
	Input c	Disconnected ▼
	Default value	<input checked="" type="radio"/> 0 <input type="radio"/> 1
	Input d	Disconnected ▼
	Default value	<input checked="" type="radio"/> 0 <input type="radio"/> 1
	Input e	Disconnected ▼
	Default value	<input checked="" type="radio"/> 0 <input type="radio"/> 1
	Input f	Disconnected ▼
	Default value	<input checked="" type="radio"/> 0 <input type="radio"/> 1
	Input g	Disconnected ▼
	Default value	<input checked="" type="radio"/> 0 <input type="radio"/> 1
	Input h	Disconnected ▼
	Default value	<input checked="" type="radio"/> 0 <input type="radio"/> 1
	Result is inverted	<input checked="" type="radio"/> No <input type="radio"/> Yes
	Read input object value after bus voltage recovery	<input checked="" type="radio"/> No <input type="radio"/> Yes
	Output send when	<input checked="" type="radio"/> Receiving a new telegram <input type="radio"/> Every change of output object
	Send delay time: Base	None ▼
	Factor: 1..255	1 ▲▼

图 5.7.1 “Logic function_AND/OR/XOR” 功能参数

参数“Input a/b/c/d/e/f/g//h”

此参数设置逻辑输入 input x 是否参与运算，是正常参与运算，还是取反参与运算。可选项：

Disconnected

Normal

Inverted

Disconnected: 未连接，不参与运算；

Normal: 输入值直接参与运算；

Inverted: 对输入值进行取反，再参与运算。注：不对初始值进行取反操作。

——参数“Default value”

设置逻辑输入 input x 的初始值。可选项：

0

1

参数“Result is inverted”

此参数设置是否对逻辑运算结果进行取反操作。可选项：

No

Yes

No: 直接输出；

Yes: 取反，再输出。

参数“Read input object value after bus voltage recovery”

此参数设置设备在上电复位后或编程后，是否向逻辑输入对象发送读请求。可选项：

No

Yes

参数"Output send when"

此参数设置发送逻辑运算结果的条件。可选项：

Receiving a new telegram

Every change of output object

Receiving a new telegram: 每接收到一个新的逻辑输入值, 逻辑结果都会发送到总线上;

Every change of output object: 逻辑结果发生改变时, 才发送到总线上。

注: 首次进行逻辑运算时, 逻辑运算结果不改变, 也会发送。

参数"Send delay time"

Base: None

0.1s

1s

...

10s

25s

Factor: 1..255

设置发送逻辑运算结果到总线的延时时间。延时=Base x Factor, 如 Base 选项为"None", 则无延时。

5.7.2 “Gate forwarding”功能参数

1.1.1 KNX Smart Touch S10 > Logic function > 1st Logic function-...

Home page	Description for logic function	<input type="text"/>
+ Display view	Function of channel	Gate forwarding ▼
+ KNX Channel	Object type of Input/Output	1bit ▼
+ KNX Scene	Default scene NO. of Gate after startup [1~64,0=inactive]	0 ▲▼
Internal sensor measureme...	1->Gate trigger scene NO. is [1~64,0=inactive]	0 ▲▼
Human Centric Lighting(H...	Input A send on	Output A ▼
+ HVAC controller	Input B send on	Output B ▼
+ Schedule function	Input C send on	Output C ▼
	Input D send on	Output D ▼

图 5.7.2 “Logic function_Gate forwarding” 功能参数

参数“Object type of Input/Output”

此参数设置输入/输出对象的数据类型。可选项：

1bit

4bit

1byte

参数“Default scene NO. of Gate after startup [1..64, 0=inactive]”

此参数设置设备启动后，默认可进行逻辑门转发的初始场景，此场景需在参数中有配置。

可选项：**1..64**，**0=不激活**

提示：操作前建议先选择门场景，否则默认启用初始场景。

参数“x->Gate trigger scene NO.[1..64,0=inactive]” (x:1~8)

此参数设置逻辑门转发的场景号。每个逻辑最多提供 8 个触发场景的设置，可选项：**1..64**，**0**=不激活。

——参数“Input A/B/C/D send on”

此参数设置输入 X (X=A/B/C/D) 经门转发后的输出。可选项：

Output A

Output B

...

Output B,C,D

根据选项，一个输入可转发成一个或多个输出。输入的值和输出的值是相同的。

5.7.3 “Threshold comparator”功能参数

1.1.1 KNX Smart Touch S10 > Logic function > 1st Logic function-...

Home page	Description for logic function	
+ Display view	Function of channel	Threshold comparator
+ KNX Channel	Threshold value data type	1byte unsigned value (DPT5.010)
+ KNX Scene	Threshold value	0
Internal sensor measureme...	If Object value<Threshold value	Do not send telegram
Human Centric Lighting(H...	If Object value=Threshold value	Do not send telegram
+ HVAC controller	If Object value!=Threshold value	Do not send telegram
+ Schedule function	If Object value>Threshold value	Do not send telegram
+ Alarm function	If Object value<=Threshold value	Do not send telegram
+ Input function	If Object value>=Threshold value	Do not send telegram
- Logic function	Output send when	<input checked="" type="radio"/> Receiving a new telegram <input type="radio"/> Every change of output object
	Send delay time: Base	None
	Factor: 1..255	1

图 5.7.3 “Logic function_Threshold comparator” 功能参数

参数“Threshold value data type”

此参数设置阈值的数据类型。可选项：

4bit value (DPT3.007)

4byte unsigned

value[0..4294967295]

1byte unsigned value (DPT5.010)

Ext. temperature value

(DPT 9.001)

2byte unsigned value (DPT7.001)

Ext. humidity value (DPT

9.007)

2byte signed value (DPT8.x)

Illuminance value (DPT

9.004)

2byte float value (DPT9.x)**——参数“Threshold value ”**

此参数设置阈值，阈值的范围由数据类型决定。可选项：

4bit value (DPT3.007) 0..15 / 1byte unsigned value (DPT5.010) 0..255 /

2byte unsigned value (DPT7.001) 0..65535 / 2byte signed value (DPT8.x)

-32768..32767 /

2byte float value (DPT9.x) -670760...670760 / 4byte unsigned

value[0..4294967295] 0..4294967295 /

Ext. temperature value (DPT 9.001) -20..95°C / Ext. humidity value (DPT 9.007)

0..100% /

Illuminance value (DPT 9.004) 0..65535lux

参数“**If Object value<Threshold value**”

参数“**If Object value=Threshold value**”

参数“**If Object value!=Threshold value**”

参数“**If Object value>Threshold value**”

参数“**If Object value<=Threshold value**”

参数“**If Object value>=Threshold value**”

这些参数设置对象输入的阈值小于、等于、不等于、大于、小于等于或大于等于设定的阈值时，应发送的逻辑结果值。当数据类型为“2byte float value (DPT9.x)”、“Illuminance value (DPT 9.004)”时，只能设置对象输入的阈值小于或者大于设定的阈值。可选项：

Do not send telegram

Send value "0"

Send value "1"

Do not send telegram: 不考虑选择此选项的参数;

Send value "0"/"1": 当满足条件时, 发送报文值 0 或 1。

如参数间设置选项存在冲突, 以达到最后参数条件应发送的值为准。例如: 参数 **"If Object**

value=Threshold value"设置 **Send value "0"**;参数**"If Object value<=Threshold value"**

设置 **Send value "1"**; 当对象值等于阈值时, 逻辑结果将发送值 **"1"**。

参数"Output send when"

此参数设置发送逻辑运算结果的条件。可选项:

Receiving a new telegram

Every change of output object

Receiving a new telegram: 对象每接收到一个新的输入值, 逻辑结果都会发送至总线上;

Every change of output object: 逻辑结果发生改变时, 才发送至总线上。

提示: 首次进行逻辑运算, 逻辑运算结果不改变, 也会发送。

参数"Send delay time: Base"

Base:

None

0.1s

1s

...

25s

Factor: 1..255

此参数设置发送逻辑运算结果至总线的延时时间。延时=Base x Factor，如 Base 选项为“None”，则无延时。

5.7.4 “Format convert”功能参数



图 5.7.4 “Logic function _Format convert” 功能参数

参数“Function”

此参数设置发送逻辑运算结果的条件。可选项：

- 2x1bit-->1x2bit**
- 8x1bit-->1x1byte**
- 1x1byte-->1x2byte**
- 2x1byte-->1x2byte**
- 2x2byte-->1x4byte**
- 1x1byte-->8x1bit**
- 1x2byte-->2x1byte**
- 1x4byte-->2x2byte**
- 1x3byte-->3x1byte**
- 3x1byte-->1x3byte**

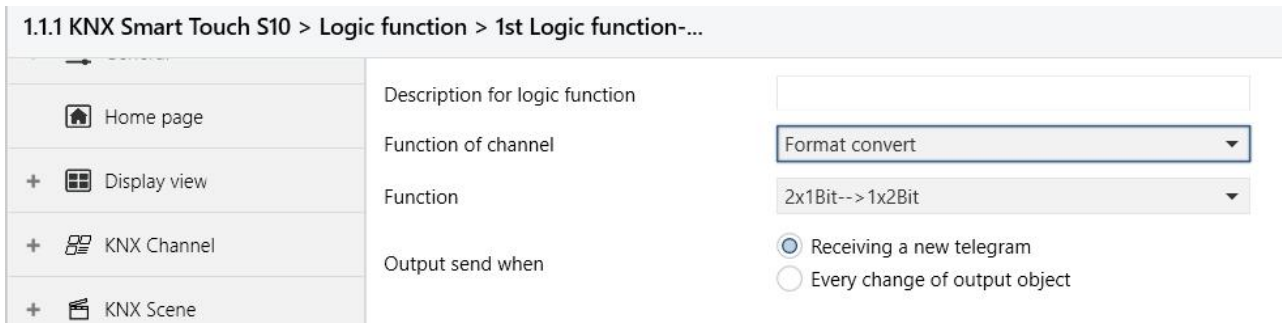
参数“Output send when”

此参数设置发送逻辑结果的条件。可选项：

Receiving a new telegram

Every change of output object

Receiving a new telegram: 对象每接收一个新的输入值, 逻辑结果都会发送至总线上;

Every change of output object: 逻辑结果发生改变时, 才发送至总线上。

提示: 首次进行逻辑运算, 逻辑运算结果不改变, 也会发送。

5.7.5 “Gate function”功能参数

1.1.1 KNX Smart Touch S10 > Logic function > 1st Logic function-...

Home page	Description for logic function	<input type="text"/>
+ Display view	Function of channel	Gate function
+ KNX Channel	Object type of Input/Output	1bit[On/Off]
+ KNX Scene	Filter function	Deactivate
Internal sensor measureme...	Value output	<input checked="" type="radio"/> Normal <input type="radio"/> Inverted
Human Centric Lighting(H...	Gate object value	<input checked="" type="radio"/> Normal <input type="radio"/> Inverted
HVAC controller	Gate status after voltage recovery	<input type="radio"/> Disable <input checked="" type="radio"/> Enable
	Save input signal when gate close	<input checked="" type="radio"/> No <input type="radio"/> Yes

图 5.7.5 “Gate function”功能参数

参数“Object type of Input/Output”

此参数用于设置输入/输出的对象类型。可选项:

1bit[On/Off]

1byte[0...100%]

1byte[0...255]

2byte[Float]

2byte[0...65535]

选择“1bit”时，以下参数可见。

——参数“Filter function ”

此参数设置是否过滤 ON 或 OFF 报文，仅让其中一个通过，或者都可通过。可选项：

Deactivate

On filter out

Off filter out

——参数“Value output ”

此参数设置对输出值是否进行取反，再输出。可选项：

Normal

Inverted

参数“Gate object value”

此参数设置对门的对象值是否进行取反。可选项：

Normal

Inverted

参数“Gate status after voltage recovery”

此参数设置设备启动后门的状态。可选项：

Disable

Enable

参数“ Save input signal when gate close”

此参数设置门关时是否保存输入信号。可选项：

No

Yes

Yes: 门关期间接收到的输入值, 在门开时会进行输出 (无论输入值是否改变)。

NO: 门关期间收到的输入值被忽略。

5.7.6 “Delay function”功能参数

1.1.1 KNX Smart Touch S10 > Logic function > 1st Logic function-...

Home page	Description for logic function	<input type="text"/>
+ Display view	Function of channel	Delay function
+ KNX Channel	Object type of Input/Output	1bit[On/Off]
	Delay time [0..6500]	10 s

图 5.7.6 “Delay function”功能参数

参数“Object type of Input/Output”

此参数设置输入/输出对象类型。可选项：

1bit[On/Off]

1byte[0..100%]

1byte[0..255]

2byte[Float]

2byte[0..65535]

参数“Delay time [0..6500]s”

此参数设置输入对象收到报文后输出对象将值转发出去的延时时间。可选项：**0..6500**

注意：延时期间，再次收到输入时，重新计时。

5.7.7 “Staircase lighting”

1.1.1 KNX Smart Touch S10 > Logic function > 1st Logic function-...

Home page	Description for logic function	<input type="text"/>
+ Display view	Function of channel	Staircase lighting
+ KNX Channel	Trigger value	1
+ KNX Scene	Object type of output	<input checked="" type="radio"/> 1bit <input type="radio"/> 1byte
Internal sensor measureme...	Duration time of staircase lighting[10..6500]	10 s
Human Centric Lighting(H...	Send value 1 when trigger	<input type="radio"/> OFF <input checked="" type="radio"/> ON
+ HVAC controller	Send value 2 after duration time	<input checked="" type="radio"/> OFF <input type="radio"/> ON
	Retriggering	<input type="radio"/> Disable <input checked="" type="radio"/> Enable

图 5.7.7 “Staircase lighting”功能参数

参数“Trigger value”

此参数设置对象“Trigger value”的报文值。可选项：

0

1

0 or 1

参数“Object type of output”

此参数设置输出的对象类型。可选项：

1bit

1byte

参数“Duration time of staircase lighting[10..6500]s”

此参数设置楼梯灯开启后楼梯照明持续时间。可选项：**10..6500**

参数“Send value 1 when trigger”

参数“Send value 2 after duration time”

这两个参数设置发送的值。当触发时发送值 1，当延时过后发送值 2。选项根据输出的对象类型显示。

1bit 时，可选项：

OFF

ON

1byte 时，可选项：**0..255**

参数“Retriggering”

此参数设置在延时期间，再次接收触发值，是否重新触发计时。可选项：

Disable

Enable

5.8 参数设置界面 “Scene group function”

该界面在图 5.2.8“Advanced setting”中的参数“Scene group function”选择使能时可见，用于使能场景组功能，最多有 8 组场景功能可供设置，每组有 8 个输出。如下图所示

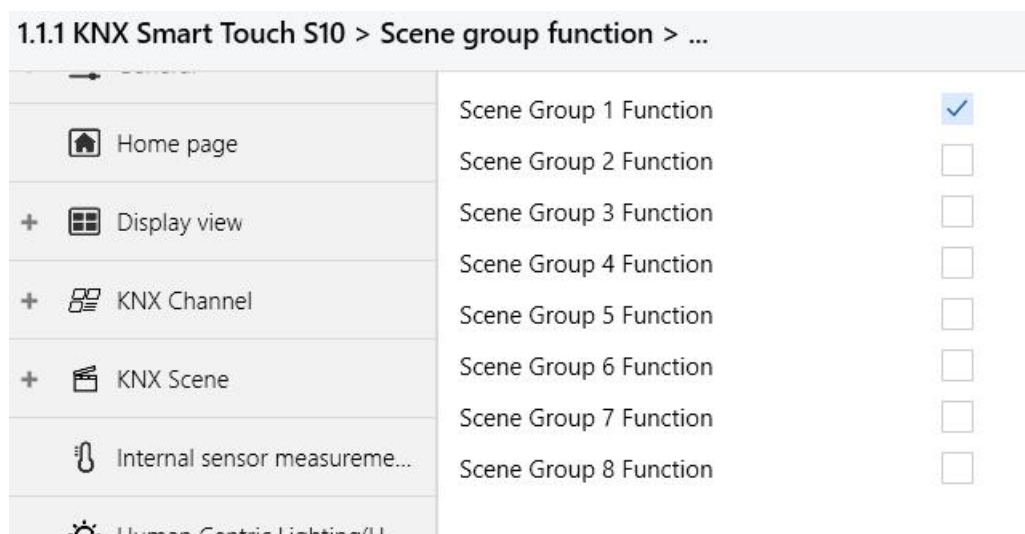

5.8(1) “Scene Group function”参数设置界面



图 5.8(2) “Group X”参数设置界面

1.1.1 KNX Smart Touch S10 > Scene group function > Group 1 > Output 1 Function

Home page	Description for Output 1 function	<input type="text"/>
+ Display view	Object type of Output 1	1bit
+ KNX Channel	1->Output 1 trigger scene NO. is [1~64,0=inactive]	0
+ KNX Scene	Object value of Output 1	<input checked="" type="radio"/> 0 <input type="radio"/> 1
Internal sensor measureme...	Delay time for sending [0..255]	0 *0.1s
Human Centric Lighting(H...	2->Output 1 trigger scene NO. is [1~64,0=inactive]	0
+ HVAC controller	Object value of Output 1	<input checked="" type="radio"/> 0 <input type="radio"/> 1
+ Schedule function	Delay time for sending [0..255]	0 *0.1s

图 5.8(3) “Output Y function”参数设置界面

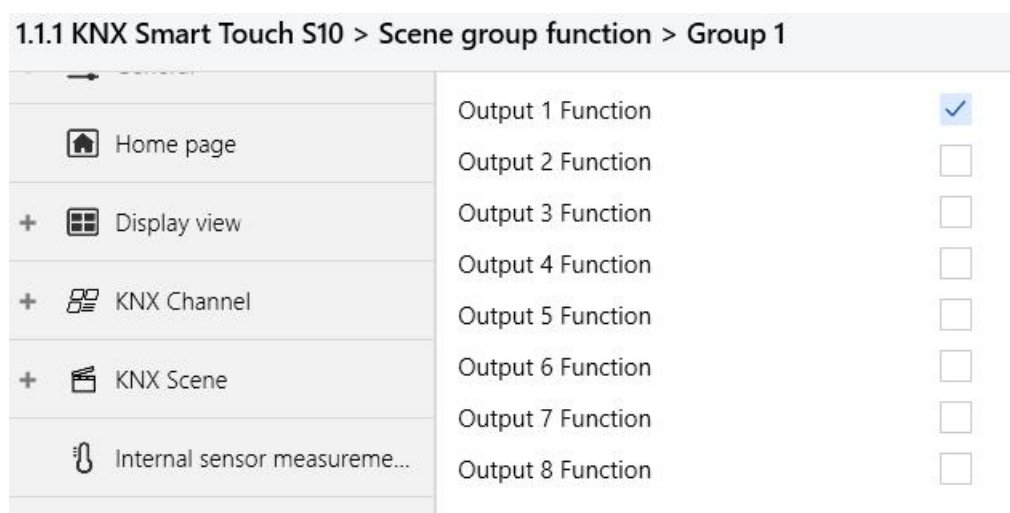
参数“Scene Group x Function, (X=1-8)”

此参数设置是否使能场景组 x 功能，最多可以设置 8 个场景组。

参数“Output y Function, (X=1-8)”

此参数设置是否使能场景组 x 的输出 y，每个场景组最多可以设置 8 个输出功能。

由于 8 组的功能相同，且组中 8 个输出功能也相同，下面我们以其中一组的其中一个输出为例进行

参数说明：

参数“Description for Output y function, (y=1-8)”

此参数设置 x 组中输出 y 的名称描述。最多可输入 30 个字符。

参数“Object type of Output 1 y, y=(1-8)”

此参数用于定义 x 组中输出 y 的数据类型。可选项：

1bit

1byte

2byte**RGB****RGBW****——参数“Object datatype”**

此参数用于定义 1byte 或者 2byte 的数据类型。

1byte 时，可选项：

1byte unsigned value**HVAC mode**

2byte 时，可选项：

2byte unsigned value**Temperature value**

参数“z->Output 1 trigger scene NO. is [1~64,0=inactive],(z=1-8)”

此参数用于定义 x 组中输出 y 被触发的场景号。每个输出最多可提供 8 个触发场景。可选项：**0..64**,

0=不激活。

——参数“Object value of Output y”

此参数设置输出值，值的范围由输出 y 的数据类型决定。

当选择 1bit 时，可选项：**0..1**

当选择 1byte-1byte unsigned value 时，可选项：**0..255**

当选择 1byte-HVAC mode 时，可选项：

Comfort mode 舒适模式

Standby mode 待机模式

Economy mode 节能模式

Frost/heat protection 保护模式

当选择 2byte-2byte unsigned value 时，可选项：**0..65535**

当选择 2byte-Temperature value 时，可选项：

-5°C

-4°C

...

45°C

——参数“**RGB value of Output y**”

选择 RGB 时可见，用于设置 RGB 输出值。可选项：**#000000...#FFFFFF**

——参数“**White value of Output y**”

选择 RGBW 时，用于设置白光输出值。可选项：**0.255**

——参数“**Delay time for sending [0...255]*0.1s**”

此参数设置输出值延时发送到总线上的时间。可选项：**0..255**

5.9 设置参数界面 “Home page”

1.1.1 KNX Smart Touch S10 > Home page

- KNX Secure
- + General
- Home page**
- + Display view
- + KNX Channel
- + KNX Scene
- Internal sensor measureme...
- Human Centric Lighting(H...
- + HVAC controller
- + Schedule function
- + Alarm function
- + Input function
- Logic function
- Function setting
- 1st Logic function-...
- + Scene group function

Overwrite the home page setting during download

Widget selection in the home page

Number of widgets (max. 24 channels or scenes)

▼	▼	▼	▼
▼	▼	▼	▼
▼	▼	▼	▼

i Note: If the channel or scene is not enabled, it can not be selected.

Layout preview





Function layout	Function including	Preview
Single grid	Press/Release switch, Switch, Relative dimming, RGB dimming, RGBW dimming, RGBCW dimming, Energy metering, Temperature sensor, Humidity sensor, PM2.5 sensor, PM10 sensor, VOC sensor, AQI sensor, CO2 sensor, Brightness sensor, Wind sensor, I/O sensor, Value sender, Scene	
Horizontal double grid	Curtain step/move, Roller blind step/move, Curtain position, Roller blind position, Venetian blind position and slat, Air conditioner, Room temperature unit.	

图 5.9 “Home page”参数设置界面

参数“Overwrite the home page setting during download”

此参数设置下载期间是否覆写主页的设置。

Widget selection in the home page 主页中设备设置

参数“Number of widgets (max.24 channels or scenes)”

此参数设置需要在主页中显示的设备数量。可选项：**1...24**

设备可选 **Channel 1...Channel 120/Scene 1-Scene 30**

5.10 设置参数界面 “Display view”

1.1.1 KNX Smart Touch S10 > Display view

- KNX Secure
- General
- Home page

+ Display view

- KNX Channel
- KNX Scene
- Internal sensor measureme...
- Human Centric Lighting(H...
- HVAC controller
- Schedule function
- Alarm function
- Input function
- Logic function
- Function setting
- 1st Logic function-...
- Scene group function

Setting for area view

Number of areas (max. 12)

Layout preview

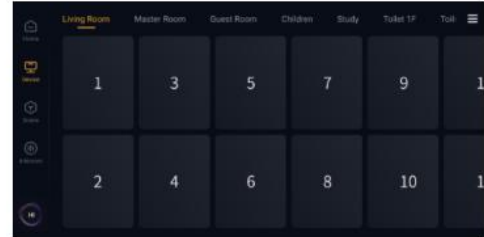

Category setting for device view

Item	Category name description	Function including
Lighting	Lighting	Switch, Relative dimming, Brightness dimming, Relative&Brightness dimming, RGB dimming, RGBW dimming, RGBCW dimming, Colour temperature dimming
Curtain	Curtain	Curtain step/move, Roller blind step/move, Curtain position, Roller blind position, Venetian blind position and slat
HVAC	HVAC	Air conditioner, Room temperature unit, Ventilation system
Audio	Audio	Audio control
Energy	Energy	Energy metering
Environment	Environment	Temperature sensor, Humidity sensor, PM2.5 sensor, PM10 sensor, VOC sensor, AQI sensor, CO2 sensor, Brightness sensor, Wind sensor
I/O Sensor	I/O Sensor	I/O sensor
Other	Other	Press/Release switch, Value sender

Layout preview

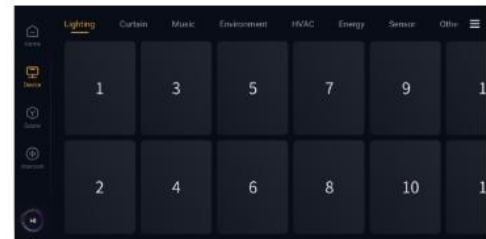

- Logic function
- Function setting
- 1st Logic function-...
- Scene group function

图 5.10 “Display view”参数设置界面

Setting for area view 区域视图设置

参数“Number of areas (max.12)”

此参数设置区域的数量。可选项：**1....12****Category description setting for device view 设备视图的类别描述设置**

参数	功能描述
Lighting	灯光(开关、相对调光、绝对调光(亮度调节)、相对+绝对调光,色温调节、RGBRGBW、RGCW)
Curtain	窗帘(开合帘、卷帘、百叶帘、开合帘开关停、卷帘上下停,无线窗帘面板)
HVAC	暖通设备(温控、温控(开关)、温控(操作模式)、温控(开关+操作模式)、温控(操作模式+风速)、温控(开关+操作模式+风速)、空调(不扫风)、空调(扫风)、新风系统(无自动风速)、新风系统(有自动风速))
Audio	音乐(背景音乐(基础款)、背景音乐(开关)、背景音乐(播放模式)、背景音乐(播放模式+歌曲信息)、背景音乐(歌曲列表+歌曲信息))
Energy	能源(能源监测(功率+能量)、能源监测(功率+能量+电流)、能源监测(功率+能量+电流+电压))
Environment	环境状态(空气质量、二氧化碳传感器、PM2.5 传感器 VOC 传感器、PM10 传感器、温度传感器、湿度传感器、照度传感器、风传感器)

I/O Sensor	传感器 (I/O 信号传感器)
Other	Press/Release switch (按下/松开开关)、值发送

5.11 设置参数界面 “KNX Channel”

1.1.1 KNX Smart Touch S10 > KNX Channel

- KNX Secure
- General
- Home page
- Display view
- KNX Channel**
- KNX Scene
- Internal sensor measureme...
- Human Centric Lighting(H...
- HVAC controller
- Schedule function
- Alarm function
- Input function
- Logic function
- Function setting
- 1st Logic function-...
- Scene group function

Number of channels (max. 240) 1

For 14 Bytes string from bus, The encode data of telegram must be ISO8859 or ASCII characters.

Channel status object read request after restart

Time period request for common 1 [0..255,0=inactive] 0 min

Time period request for common 2 [0..255,0=inactive] 0 min

Time period request for common 3 [0..255,0=inactive] 0 min

Time period request for common 4 [0..255,0=inactive] 0 min

Time period request for common 5 [0..255,0=inactive] 0 min

Time period request for common 6 [0..255,0=inactive] 0 min

Time period request for common 7 [0..255,0=inactive] 0 min

Time period request for common 8 [0..255,0=inactive] 0 min

Time period request for common 9 [0..255,0=inactive] 0 min

Time period request for common 10 [0..255,0=inactive] 0 min

PM2.5/PM10 monitoring level indication setting

Number of level 1

Home page	PM2.5/PM10 monitoring level indication setting	
Display view	Number of level	1
KNX Channel	For level 0	
KNX Scene	Colour setting	Green
Internal sensor measureme...	Threshold for level 0<->level 1	35
Human Centric Lighting(H...	Colour setting	Light blue
HVAC controller	AQI monitoring level indication setting	
Schedule function	Number of level	1
Alarm function	For level 0	
Input function	Colour setting	Green
Logic function	Threshold for level 0<->level 1	50
Function setting	Colour setting	Light blue
1st Logic function-...	CO2 level indication setting	
Scene group function	Number of level	1
	For level 0	
	Colour setting	Green
	Threshold for level 0<->level 1	350
	Colour setting	Light blue

图 5.11 “KNX Channel”参数设置界面

参数“Number of channels (max.240)”

此参数设置通道（设备）的数量。可选项：**1....240**

参数“Channel status object read request after restart ”

此参数设置在设备重启时，是否发送设备状态读请求报文。

参数“Time period request for common X [0..255,0=inactive] ,(X=1-10)”

此参数设置查询通用设备在线状态的请求周期。可选项：**0...255min**

PM2.5/PM10/AQI/CO2/ monitoring level indication setting**PM2.5/PM10/AQI/CO2 监测水平指示设置**

参数“Number of level”

此参数设置等级数量。可选项：**1...5**

参数“Colour setting”

此参数设置各个等级 UI 显示的颜色。可选项：

Green

Light blue

Yellow

Orange

Red

Dark red

参数“Threshold for level 0<->level 1”

参数“Threshold for level 1<->level 2”

参数“Threshold for level 2<->level 3”

参数“Threshold for level 3<->level 4”

参数“Threshold for level 4<->level 5”

此参数用于设置各个等级的阈值。可选项：**1...500/1...999**

5.11.1 设置参数界面 “Channel X”(X=1~240)



图 5.11.1 “Channel X”参数设置界面

参数“Function”

此参数设置设备功能。Channel 1-120 可选项：

Press/Release switch 按下/松开开关

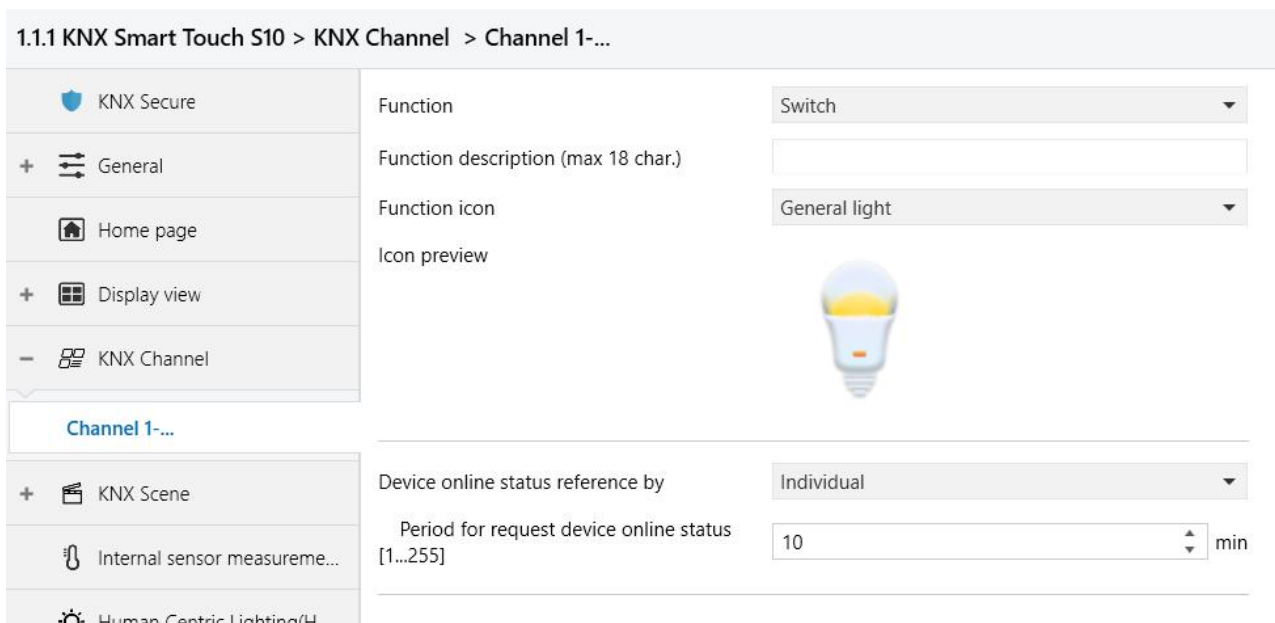
Switch 开关

Relative dimming 相对调光

Brightness dimming 亮度调光

Relative&Brightness dimming 相对&亮度调光

RGB dimming RGB 调光

RGBW dimming RGBW 调光

RGBCW dimming RGBCW 调光

Colour temperature dimming 色温调节

Curtain step/move 普通开合帘

Ventilation system 新风系统

Ventilation system(with auto fan speed)

新风系统 (带自动风速)

Audio control 背景音乐

Audio control(with on/off)

背景音乐 (带开/关)

Audio control(play mode)

背景音乐 (播放模式)

Audio control(track information)

背景音乐 (歌曲信息)

Roller blind step/move 普通卷帘	Audio control(track information & playlist)
Curtain position 带行程的开合帘	背景音乐 (歌曲信息和播放列表)
Roller blind position 带行程的卷帘	Energy metering(power & energy)
Venetian blind position and slat 百叶帘	能源计量 (功率和能量)
Air conditioner 空调	Energy metering(power & energy & current)
Air conditioner(with swing) 空调(带摆风)	能源计量(功率、能量、电流)
Room temperature unit 温控器	Energy metering(power & energy & current & voltage)
Room temperature unit(with on/off) 温控器 (带开关功能)	能源计量 (功率、能量、电压、电流)
Room temperature unit(with operation mode) 温控器 (带操作模式)	Temperature sensor 温度传感器
Room temperature unit(with on/off & operation mode) 温控器 (带开/关和操作模式)	Humidity sensor 湿度传感器
Room temperature unit(with operation mode & fan speed) 温控器(带操作模式和风速调节)	PM2.5 sensor PM2.5 传感器
Room temperature unit(with on/off&operation mode & fan speed) 温控器(带开关、操作模式和风速调节)	PM10 sensor PM10 传感器
	VOC sensor VOC 传感器
	AQI sensor AQI 传感器
	CO2 sensor CO2 传感器
	Brightness sensor 亮度传感器
	Wind sensor 风速传感器
	I/O sensor I/O 传感器
	Value sender 值发送

此参数设置设备功能。Channel 121-240 可选项：

Press/Release switch	按下/松开开关	Curtain step/move	普通开合帘
Switch	开关	Roller blind step/move	普通卷帘
Relative dimming	相对调光	Curtain position	带行程的开合帘
Brightness dimming	亮度调光	Roller blind position	带行程的卷帘
Relative&Brightness dimming	相对&亮度调光	Venetian blind position and slat	百叶帘
RGB dimming	RGB 调光	Value sender	值发送
RGBW dimming	RGBW 调光		
RGBCW dimming	RGBCW 调光		
Colour temperature dimming	色温调节		

参数“Function description (max 18 char.)”

此参数设置设备的功能描述，最多可输入 18 个字符。

参数“Function icon”

此参数设置设备功能使用的图标。可选项：

General light

Ceiling light

...

AQI

每个功能所对应的默认图标和其它选项所对应的图标请查看附件文档说明。







以下章节将对设备功能进行详细说明。

5.11.2 基本功能参数

此章节说明功能页的开关、调光、窗帘、值发送、色温、颜色控制(RGB、RGBW、RGBCW)、背景音乐、温控功能、空调控制、新风系统控制、并支持空气质量传感器检测值显示和能源检测值显示等功能。

5.11.2.1.开关功能

1.1.1 KNX Smart Touch S10 > KNX Channel > Channel 1-...

 KNX Secure	Function	Switch
+  General	Function description (max 18 char.)	<input type="text"/>
 Home page	Function icon	General light
+  Display view	Icon preview	
-  KNX Channel		
Channel 1-...		
+  KNX Scene	Device online status reference by	Always online

5.11.2(1) 开关功能参数设置界面

参数“Device online status reference by”

此参数设置向总线 KNX 设备发送读请求的参考类型。可选项：

Individual

Common 1

...

Common 10

Always online

注：（**Press/Release switch** 和值发送，只读显示 **Always online**）

——参数“**Period for request device online status [1..255] min**”

当上个参数选择“Individual”时，此参数可见。此参数用于设置单个设备在线状态请求的时间周期。

可选项：**0...255**

5.11.2.2. 按下/松开开关功能



图 5.11.2(2) 按下/松开开关功能参数设置界面

参数“Work mode”

此参数用于配置按下和松开所发送的开关值。可选项：

Press - ON / Release - OFF

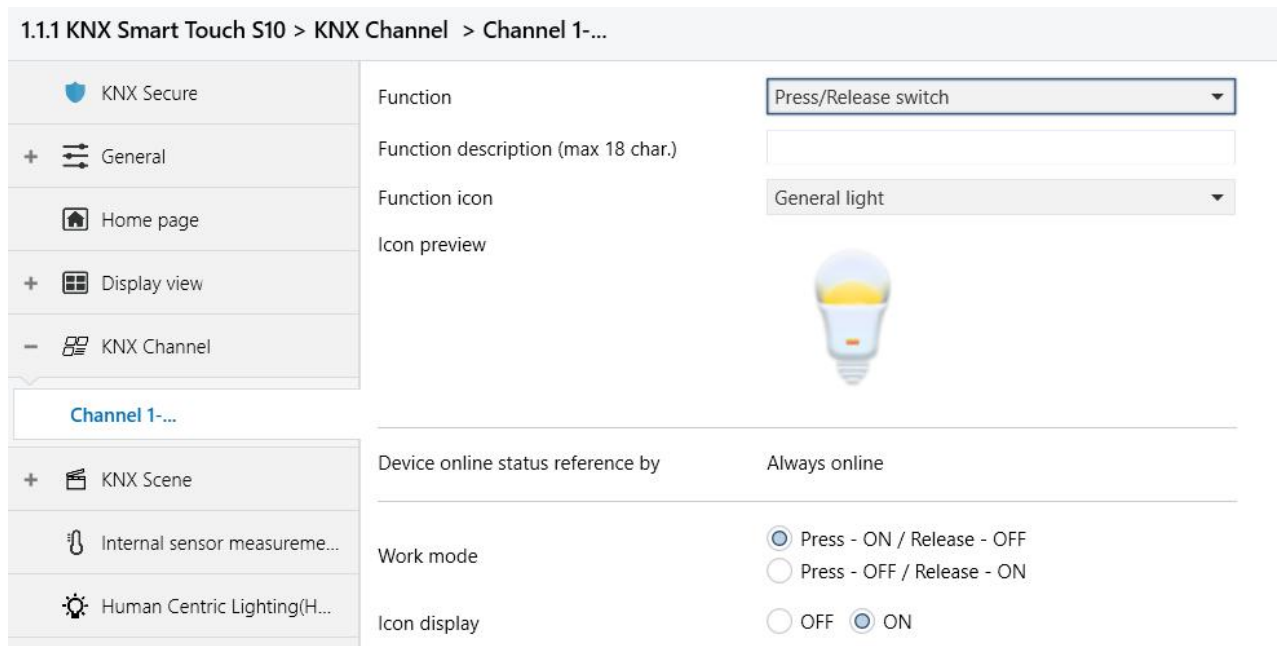
Press - OFF / Release - ON

参数“Icon display”

此参数设置屏上图标的指示状态。可选项：

OFF

ON

5.11.2.3.相对调光、亮度调节、相对&亮度调节

1.1.1 KNX Smart Touch S10 > KNX Channel > Channel 1-...

<ul style="list-style-type: none"> KNX Secure + General Home page + Display view - KNX Channel Channel 1-... + KNX Scene 	<p>Function: Relative dimming</p> <p>Function description (max 18 char.):</p> <p>Function icon: General light</p> <p>Icon preview: </p> <p>Device online status reference by: Always online</p>
------------------------------------------------------------------------------------------------------------------------------------------------------------------------------------------------------	-----------------------------------------------------------------------------------------------------------------------------------------------------------------------------------------------------------------------------------------------------------------------------------

Relative dimming

1.1.1 KNX Smart Touch S10 > KNX Channel > Channel 1-...

<ul style="list-style-type: none"> KNX Secure + General Home page + Display view - KNX Channel Channel 1-... + KNX Scene Internal sensor measureme... Human Centric Lighting(H... 	<p>Function: Brightness dimming</p> <p>Function description (max 18 char.):</p> <p>Function icon: General light</p> <p>Icon preview: </p> <p>Device online status reference by: Always online</p> <p>Min. brightness value [0...50]: 0 %</p> <p>Max. brightness value [51...100]: 100 %</p>
---------------------------------------------------------------------------------------------------------------------------------------------------------------------------------------------------------------------------------------------------------------------------------	---------------------------------------------------------------------------------------------------------------------------------------------------------------------------------------------------------------------------------------------------------------------------------------------------------------------------------------------------------------------------------

Brightness dimming

1.1.1 KNX Smart Touch S10 > KNX Channel > Channel 1-...

<ul style="list-style-type: none"> KNX Secure + General Home page + Display view - KNX Channel Channel 1-... + KNX Scene Internal sensor measureme... Human Centric Lighting(H... 	<p>Function: <input type="text" value="Relative&Brightness dimming"/></p> <p>Function description (max 18 char.): <input type="text"/></p> <p>Function icon: <input type="text" value="General light"/></p> <p>Icon preview: </p> <hr/> <p>Device online status reference by: <input type="text" value="Always online"/></p> <hr/> <p>Min. brightness value [0..50]: <input type="text" value="0"/> %</p> <p>Max. brightness value [51..100]: <input type="text" value="100"/> %</p>
---------------------------------------------------------------------------------------------------------------------------------------------------------------------------------------------------------------------------------------------------------------------------------	----------------------------------------------------------------------------------------------------------------------------------------------------------------------------------------------------------------------------------------------------------------------------------------------------------------------------------------------------------------------------------------------------------------------------------------------------------------------------------------------------------------------------------------------------------------------------

Relative&Brightness dimming

图 5.11.2(3) 相对/亮度调光功能参数设置界面

功能选择“**Brightness dimming/Relative&Brightness dimming**”时，以下两个参数可见。

参数“**Min. brightness value [0..50]%**”

此参数设置亮度下限阈值设置。可选项：**0..50**

参数“**Max. brightness value [51..100]%**”

此参数设置亮度上限阈值设置。可选项：**51..100**

5.11.2.4. 色温调节功能

1.1.1 KNX Smart Touch S10 > KNX Channel > Channel 1-...

<ul style="list-style-type: none"> KNX Secure + General Home page + Display view - KNX Channel Channel 1-... + KNX Scene Internal sensor measureme... Human Centric Lighting(H... + HVAC controller + Schedule function + Alarm function 	<p>Function: Colour temperature dimming</p> <p>Function description (max 18 char.):</p> <p>Function icon: Downlight</p> <p>Icon preview: </p> <hr/> <p>Device online status reference by: Always online</p> <hr/> <p>Reaction on 'OFF' operation: <ul style="list-style-type: none"> <input checked="" type="radio"/> Only switch object send value 0 <input type="radio"/> Brightness objects send value 0 </p> <p>Reaction on 'ON' operation: <ul style="list-style-type: none"> <input checked="" type="radio"/> Only switch object send value 1 <input type="radio"/> Preset brightness value </p> <p>Colour temperature control type: Normal(with 2byte absolute value)</p> <p>Min. colour temperature [2000...7000]: 2700 K</p> <p>Max. colour temperature [2000...7000]: 6500 K</p>
-------------------------------------------------------------------------------------------------------------------------------------------------------------------------------------------------------------------------------------------------------------------------------------------------------------------------------------------------------------------	------------------------------------------------------------------------------------------------------------------------------------------------------------------------------------------------------------------------------------------------------------------------------------------------------------------------------------------------------------------------------------------------------------------------------------------------------------------------------------------------------------------------------------------------------------------------------------------------------------------------------------------------------------------------------------------------------------------------------------------------------------------------------------------------------------------------------------------------------------------------------------------------------------------------------

Color temperature dimming

图 5.11.2(4) 色温调节功能参数设置界面

参数 "Reaction on 'OFF' operation"

此参数设置在操作开关按钮关时，选择是发送开关对象报文 0，还是亮度对象报文发送 0。可选项：

Only switch object send value 0

Brightness objects send value 0

参数 "Reaction on 'ON' operation"

此参数设置在操作开关按钮开时，可选择仅发送开关报文 1，还是发送预设的颜色值。可选项：

Only switch object send value 1

Preset colour brightness value

参数选择“Preset colour brightness value”时，以下参数可见。

——参数“Brightness value”

此参数设置可见预设亮度值。可选项：**0..100%**

参数“Colour temperature control type”

此参数设置色温控制的方式。可选项：

Normal(with 2byte absolute value) 普通控制(具有 2 字节绝对值)

Normal(with 1byte percentage value) 普通控制(具有 1 字节百分比值)

Directly(with warm/cool white algorithm) 直接控制(使用暖/冷白算法)

Normal: 发出 1byte 亮度和 2byte 色温值;

Directly(with warm/cool white algorithm): 直接控制, 设备已内置了“亮度值+色温值”与暖/冷白灯亮度的转换算法, 即 2 个 1byte 对象, 用于输出控制暖白灯和冷白灯的亮度调节。

——参数“Status feedback object”

上一个参数选择“Directly(with warm/cool white algorithm)”时, 此参数可见。设置选择状态反馈对象。可选项:

Brightness+2 byte Colour Temperature

Warm/cool white brightness

Brightness+2 byte Colour Temperature: 亮度+色温的反馈, 这是为了跟其他面板的数据能准确互通;

Warm/cool white brightness: 冷光暖光的反馈, 这是为了跟执行器的能互通。











参数“Min. colour temperature [2000..7000]K”

参数“Max. colour temperature [2000..7000]K”

这两个参数设置色温上下限阈值设置。可选项：**2000..7000**

5.11.2.5.RGB/RGBW/RGBCW

1.1.1 KNX Smart Touch S10 > KNX Channel > Channel 1-...

 KNX Secure	Function	RGB dimming ▾
+  General	Function description (max 18 char.)	<input type="text"/>
 Home page	Function icon	RGB light ▾
+  Display view	Icon preview	
-  KNX Channel		
Channel 1-...		
+  KNX Scene	Device online status reference by	Always online ▾
 Internal sensor measureme...	Reaction on 'OFF' operation	<input checked="" type="radio"/> Only switch object send value 0 <input type="radio"/> Brightness objects send value 0
 Human Centric Lighting(H...	Reaction on 'ON' operation	<input checked="" type="radio"/> Only switch object send value 1 <input type="radio"/> Preset colour brightness value
+  HVAC controller	Object datatype	<input checked="" type="radio"/> 1x3byte <input type="radio"/> 3x1byte
+  Schedule function		

RGB dimming

1.1.1 KNX Smart Touch S10 > KNX Channel > Channel 1-...

<ul style="list-style-type: none"> 🛡️ KNX Secure + 🔄 General 🏠 Home page + 📺 Display view - 📁 KNX Channel 	<p>Function: RGBW dimming</p> <p>Function description (max 18 char.):</p> <p>Function icon: RGB light</p> <p>Icon preview:</p> 
<p>Channel 1-...</p> <ul style="list-style-type: none"> + 📄 KNX Scene 📡 Internal sensor measureme... 💡 Human Centric Lighting(H... + 🌡️ HVAC controller + 🕒 Schedule function 	<p>Device online status reference by: Always online</p> <p>Reaction on 'OFF' operation:</p> <ul style="list-style-type: none"> <input checked="" type="radio"/> Only switch object send value 0 <input type="radio"/> Brightness objects send value 0 <p>Reaction on 'ON' operation:</p> <ul style="list-style-type: none"> <input checked="" type="radio"/> Only switch object send value 1 <input type="radio"/> Preset colour brightness value <p>Object datatype:</p> <ul style="list-style-type: none"> <input checked="" type="radio"/> 1x6byte <input type="radio"/> 4x1byte

RGBW dimming

1.1.1 KNX Smart Touch S10 > KNX Channel > Channel 1-...

<ul style="list-style-type: none"> KNX Secure + General Home page + Display view - KNX Channel 	<p>Function: RGBCW dimming</p> <p>Function description (max 18 char.):</p> <p>Function icon: RGB light</p> <p>Icon preview: </p>
<ul style="list-style-type: none"> Channel 1-... + KNX Scene Internal sensor measureme... Human Centric Lighting(H... + HVAC controller + Schedule function + Alarm function + Input function 	<p>Device online status reference by: Always online</p> <p>Reaction on 'OFF' operation: <ul style="list-style-type: none"> <input checked="" type="radio"/> Only switch object send value 0 <input type="radio"/> Brightness objects send value 0 </p> <p>Reaction on 'ON' operation: <ul style="list-style-type: none"> <input checked="" type="radio"/> Only switch object send value 1 <input type="radio"/> Preset colour brightness value </p> <p>RGB object datatype: <input checked="" type="radio"/> 1x3byte <input type="radio"/> 3x1byte</p> <p>Colour temperature control type: Normal(with 2byte absolute value)</p> <p>Min. colour temperature [2000...7000]: <input type="text" value="2700"/> K</p> <p>Max. colour temperature [2000...7000]: <input type="text" value="6500"/> K</p>

RGBCW dimming

图 5.11.2(5) RGB/RGBW/RGBCW 调光功能参数设置界面

参数“Reaction on 'OFF' operation”

此参数设置在操作开关按钮关时，选择是发送开关对象报文 0，还是亮度对象报文发送 0。可选项：

Only switch object send value 0

Brightness objects send value 0

参数“Reaction on 'ON' operation”

此参数设置在操作开关按钮开时，可选择仅发送开关报文 1，还是发送预设的颜色值。可选项：

Only switch object send value 1

Preset colour brightness value

参数选择“Preset colour brightness value”时，以下参数可见

——参数“RGB value”

此参数设置可见,预设颜色值。可选项: 000000#FFFFFF

——参数“White brightness value”

此参数设置可见,预设颜色值。可选项: 0..255

——参数“Brightness value”

此参数设置可见预设亮度值。可选项: 0..255

参数“Object datatype”/“RGB object datatype”

可选项: **1x3byte/3x1byte/1x6byte/4x1byte**

适用于 RGB/RGBCW 类型:

1x3byte 通过一个 3byte 的对象进行 RGB 调光

3x1byte 通过三个 1byte 的对象进行 RGB 调光

适用于 RGBW 类型:

1x6byte 通过一个 6byte 的对象进行 RGBW 调光

4x1byte 通过四个 1byte 的对象进行 RGBW 调光

当功能选择“RGBCW dimming”以下参数可见，用于设置色温调光。

参数“Colour temperature control type”

此参数设置色温控制的方式。可选项：

Normal(with 2byte absolute value) 普通控制(具有 2 字节绝对值)

Normal(with 1byte percentage value) 普通控制(具有 1 字节百分比值)

Directly(with warm/cool white algorithm) 直接控制(使用暖/冷白算法)

Normal: 发出 1byte 亮度和 2byte 色温值;

Directly(with warm/cool white algorithm): 直接控制, 设备已内置了“亮度值+色温值”与暖/冷白灯亮度的转换算法, 即 2 个 1byte 对象, 用于输出控制暖白灯和冷白灯的亮度调节。

——参数“Status feedback object”

上一个参数选择“Directly(with warm/cool white algorithm)”时, 此参数可见。设置选择状态反馈对象。可选项:

Brightness+2 byte Colour Temperature

Warm/cool white brightness

Brightness+2 byte Colour Temperature: 亮度+色温的反馈, 这是为了跟其他面板的数据能准确互通;

Warm/cool white brightness: 冷光暖光的反馈, 这是为了跟执行器的能互通。

参数“Min. colour temperature [2000..7000]K”

参数“Max. colour temperature [2000..7000]K”

这两个参数设置色温上下限阈值设置。可选项: **2000..7000**

5.11.2.6. 窗帘功能

1.1.1 KNX Smart Touch S10 > KNX Channel > Channel 1-...

<ul style="list-style-type: none"> KNX Secure + General Home page + Display view - KNX Channel Channel 1-... + KNX Scene Internal sensor measureme... Human Centric Lighting/H... 	<p>Function: Curtain step/move</p> <p>Function description (max 18 char.):</p> <p>Function icon: Curtain</p> <p>Icon preview:</p> 
	<p>Device online status reference by: Individual</p> <p>Period for request device online status [1...255]: 10 min</p>

Curtain step/move

1.1.1 KNX Smart Touch S10 > KNX Channel > Channel 1-...

<ul style="list-style-type: none"> KNX Secure + General Home page + Display view - KNX Channel Channel 1-... + KNX Scene Internal sensor measureme... 	<p>Function: Roller blind step/move</p> <p>Function description (max 18 char.):</p> <p>Function icon: Roller blind</p> <p>Icon preview:</p> 
	<p>Device online status reference by: Individual</p> <p>Period for request device online status [1...255]: 10 min</p>

Roller blind step/move

1.1.1 KNX Smart Touch S10 > KNX Channel > Channel 1-...

<ul style="list-style-type: none"> KNX Secure + General Home page + Display view - KNX Channel Channel 1-... + KNX Scene Internal sensor measureme... 	<p>Function: <input type="text" value="Curtain position"/></p> <p>Function description (max 18 char.): <input type="text"/></p> <p>Function icon: <input type="text" value="Curtain"/></p> <p>Icon preview: </p> <hr/> <p>Device online status reference by: <input type="text" value="Individual"/></p> <p>Period for request device online status [1...255]: <input type="text" value="10"/> min</p>
--------------------------------------------------------------------------------------------------------------------------------------------------------------------------------------------------------------------------------------------	------------------------------------------------------------------------------------------------------------------------------------------------------------------------------------------------------------------------------------------------------------------------------------------------------------------------------------------------------------------------------------------------------------------------------------------------------------------------------------------

Curtain position

1.1.1 KNX Smart Touch S10 > KNX Channel > Channel 1-...

<ul style="list-style-type: none"> KNX Secure + General Home page + Display view - KNX Channel Channel 1-... + KNX Scene Internal sensor measureme... 	<p>Function: <input type="text" value="Roller blind position"/></p> <p>Function description (max 18 char.): <input type="text"/></p> <p>Function icon: <input type="text" value="Roller blind"/></p> <p>Icon preview: </p> <hr/> <p>Device online status reference by: <input type="text" value="Individual"/></p> <p>Period for request device online status [1...255]: <input type="text" value="10"/> min</p>
--------------------------------------------------------------------------------------------------------------------------------------------------------------------------------------------------------------------------------------------	------------------------------------------------------------------------------------------------------------------------------------------------------------------------------------------------------------------------------------------------------------------------------------------------------------------------------------------------------------------------------------------------------------------------------------------------------------------------------------------------------

Roller blind position

1.1.1 KNX Smart Touch S10 > KNX Channel > Channel 1-...

<ul style="list-style-type: none"> KNX Secure + General Home page + Display view - KNX Channel Channel 1-... + KNX Scene Internal sensor measureme... 	<p>Function: Venetian blind position and slat</p> <p>Function description (max 18 char.):</p> <p>Function icon: Venetian blind</p> <p>Icon preview: </p> <hr/> <p>Device online status reference by: Individual</p> <p>Period for request device online status [1...255]: 10 min</p>
--------------------------------------------------------------------------------------------------------------------------------------------------------------------------------------------------------------------------------------------	------------------------------------------------------------------------------------------------------------------------------------------------------------------------------------------------------------------------------------------------------------------------------------------------------------------------------------------------------------------------

Venetian blind position and slat

图 5.11.2(6)窗帘功能参数设置界面

参数“Device online status reference by”

此参数设置向总线 KNX 设备发送读请求的参考类型。可选项：

Individual

Common 1

...

Common 10

Always online

注：（Press/Release switch 和值发送，只读显示 Always online）

当参数选择“Individual”时，以下参数可见。

参数“Period for request device online status [1..255]min”

此参数设置单个设备在线状态请求的时间周期。可选项：**0...255**

5.11.2.7. 空调控制功能

<ul style="list-style-type: none"> KNX Secure General <ul style="list-style-type: none"> General setting Security setting Night mode setting Coordinates location setting Summer time setting Proximity setting Extension Sub Panel setting Advanced setting Home page Display view KNX Channel <ul style="list-style-type: none"> Channel 1... KNX Scene <ul style="list-style-type: none"> Internal temperature meas... HVAC controller <ul style="list-style-type: none"> Controller 1... Weekly timer function 	Function	Air conditioner
	Function description (max 18 char.)	
	Function icon	Air conditioner 1
	Icon preview	
	Device online status reference by	Individual
	Period for request device online status [1...255]	10 min
	Interface display temperature	<input type="radio"/> Setpoint temperature <input checked="" type="radio"/> Actual temperature
	Room temperature reference from	<input type="radio"/> Internal sensor <input checked="" type="radio"/> External sensor
	Period for request external sensor [0...255]	10 min
	Object datatype of setpoint	<input checked="" type="radio"/> Value in °C (DPT_5.010) <input type="radio"/> Float value in °C (DPT_9.001)
	Setpoint temperature adjustment step	1K
	Min. setpoint temperature [16...32]	16 °C
	Max. setpoint temperature [16...32]	32 °C
	Timer	<input checked="" type="checkbox"/>
	Protection setting	
ON/OFF protection	<input type="checkbox"/>	
Setpoint protection	<input type="checkbox"/>	
Control mode protection	<input type="checkbox"/>	
Fan protection	<input type="checkbox"/>	

Air conditioner(External sensor)

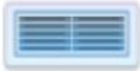
<ul style="list-style-type: none"> General General setting Security setting Night mode setting Coordinates location setting Summer time setting Proximity setting Extension Sub Panel setting Advanced setting Home page Display view KNX Channel Channel 1-... KNX Scene Internal temperature meas... HVAC controller Controller 1-... Setpoint Heating/Cooling control Fan auto.control Human Centric Lighting(H... 	Function	Air conditioner(with swing)
	Function description (max 18 char.)	
	Function icon	Air conditioner 2
	Icon preview	
	Device online status reference by	Individual
	Period for request device online status [1...255]	10 min
	Interface display temperature	<input type="radio"/> Setpoint temperature <input checked="" type="radio"/> Actual temperature
	Room temperature reference from	<input checked="" type="radio"/> Internal sensor <input type="radio"/> External sensor
	Object datatype of setpoint	<input checked="" type="radio"/> Value in °C (DPT_5.010) <input type="radio"/> Float value in °C (DPT_9.001)
	Setpoint temperature adjustment step	1K
Min. setpoint temperature [16...32]	16 °C	
Max. setpoint temperature [16...32]	32 °C	
Timer	<input checked="" type="checkbox"/>	
Protection setting		
ON/OFF protection	<input type="checkbox"/>	
Setpoint protection	<input type="checkbox"/>	
Control mode protection	<input type="checkbox"/>	
Fan protection	<input type="checkbox"/>	
Vanes swing protection	<input type="checkbox"/>	

Air conditioner(with swing)

图 5.11.2(7) 空调控制功能参数设置界面

参数“Interface display temperature”

此参数设置常态下界面的显示温度。可选项：

Setpoint temperature 设定温度

Actual temperature 室内温度

注意：如果显示室内温度，第一次操作温度加减按钮只是切换为设置温度显示，不发送报文。

——**参数“Room temperature reference from”**

此参数设置空调界面显示温度的参照来源。可选项：

Internal sensor 内部传感器

External sensor 外部传感器

——**参数“Period for request external sensor [0...255]min”**

上个参数选择“External sensor”时可见。设置设备向外部温度传感器发送读请求房间温度的时间周期。

可选项：**0..255**

注意：在设备重启时，默认会发送读请求。

参数“Object datatype of setpoint”

此参数设置温度设定值的数据类型。可选项：

Value in °C (DPT_5.010) 整型，实际温度数据

Float value in °C (DPT_9.001) 浮点型，标准 KNX 温度数据

参数“Setpoint temperature adjustment step”

此参数设置温度设定值的步进值。根据数据类型显示可选项：

0.5K

1K

选择“Value in °C (DPT_5.010)”时只有 1K。

参数“Min/Max. setpoint temperature [16..32]° C”

这两个参数用于限制温度设定值的可调节范围。设置的最小值需小于最大值，当温度设定值超出限值

范围，则按限值输出。可选项：

16°C

17°C

...

32°C

对于设定温度，最小值必须始终小于最大值，如果不符合这一条件，ETS 上的参数将不能设置。

参数“Timer”

此参数设置是否使能定时开关功能，使能后显示相应的对象，且用户可在屏上设置自定义定时间。

注意：总线只可临时关闭定时功能。

Protection setting 保护设置

参数“ON/OFF protection”

参数“Setpoint protection”

参数“Mode protection”

参数“Fan protection”

参数“Vanes swing protection”

参数“Vanes swing protection”在功能选择“Air conditioner(with swing)”时才显示。

这些参数设置是否使能功能保护，即某些功能只是显示，不让用户操作。保护功能支持开关、设定值、模式、风速控制和扫风控制。

对于功能保护，只针对用户不能操作屏或快捷键，但仍会处理接收的数据。

5.11.2.8.温控功能

<ul style="list-style-type: none"> KNX Secure General General setting Security setting Night mode setting Coordinates location setting Summer time setting Proximity setting Extension Sub Panel setting Advanced setting Home page Display view KNX Channel Channel 1-... KNX Scene Internal temperature meas... HVAC controller Controller 1-... Weekly timer function 	Function	Room temperature unit
	Function description (max 18 char.)	
	Function icon	Heating/Cooling
	Icon preview	
	Device online status reference by	Individual
	Period for request device online status [1...255]	10 min
	Controller from	<input checked="" type="radio"/> Local <input type="radio"/> Bus
	Interface display temperature	<input type="radio"/> Setpoint temperature <input checked="" type="radio"/> Actual temperature
	Room temperature reference from	<input type="radio"/> Internal sensor <input checked="" type="radio"/> External sensor
	Period for request external sensor [0...255]	10 min
	Object datatype of setpoint adjustment	<input type="radio"/> 1bit (DPT_1.007) <input checked="" type="radio"/> 2byte (DPT_9.001)
	Setpoint temperature adjustment step	<input checked="" type="radio"/> 0.5K <input type="radio"/> 1K
	Min. setpoint temperature [5...37]	10 °C
	Max. setpoint temperature [5...37]	32 °C
Control mode	Heating	
Timer	<input type="checkbox"/>	
Protection setting		
Setpoint protection	<input type="checkbox"/>	

Room temperature unit(External sensor)

<ul style="list-style-type: none"> KNX Secure General <ul style="list-style-type: none"> General setting Security setting Night mode setting Coordinates location setting Summer time setting Proximity setting Extension Sub Panel setting Advanced setting Home page Display view KNX Channel <ul style="list-style-type: none"> Channel 1-... KNX Scene <ul style="list-style-type: none"> Internal temperature meas... HVAC controller <ul style="list-style-type: none"> Controller 1-... Weekly timer function 	<p>Function: Room temperature unit(with on/off)</p> <p>Function description (max 18 char.):</p> <p>Function icon: Heating/Cooling</p> <p>Icon preview: </p> <hr/> <p>Device online status reference by: Individual</p> <p>Period for request device online status [1...255]: 10 min</p> <hr/> <p>Controller from: <input checked="" type="radio"/> Local <input type="radio"/> Bus</p> <p>Interface display temperature: <input type="radio"/> Setpoint temperature <input checked="" type="radio"/> Actual temperature</p> <p>Room temperature reference from: <input type="radio"/> Internal sensor <input checked="" type="radio"/> External sensor</p> <p>Period for request external sensor [0...255]: 10 min</p> <hr/> <p>Power on/off after download: <input type="radio"/> OFF <input checked="" type="radio"/> ON</p> <p>Power on/off after voltage recovery: Before voltage failure</p> <hr/> <p>Object datatype of setpoint adjustment: <input type="radio"/> 1bit (DPT_1.007) <input checked="" type="radio"/> 2byte (DPT_9.001)</p> <p>Setpoint temperature adjustment step: <input checked="" type="radio"/> 0.5K <input type="radio"/> 1K</p> <p>Min. setpoint temperature [5...37]: 10 °C</p> <p>Max. setpoint temperature [5...37]: 32 °C</p> <hr/> <p>Control mode: Heating</p> <p>Timer: <input type="checkbox"/></p> <hr/> <p>Protection setting</p> <p>ON/OFF protection: <input type="checkbox"/></p> <p>Setpoint protection: <input type="checkbox"/></p>
-----------------------------------------------------------------------------------------------------------------------------------------------------------------------------------------------------------------------------------------------------------------------------------------------------------------------------------------------------------------------------------------------------------------------------------------------------------------------------------------------------------------------------------------------------------------------------------------------------------------------------------------------------------------------------------------------------------------------------------------------------------------------------------	-----------------------------------------------------------------------------------------------------------------------------------------------------------------------------------------------------------------------------------------------------------------------------------------------------------------------------------------------------------------------------------------------------------------------------------------------------------------------------------------------------------------------------------------------------------------------------------------------------------------------------------------------------------------------------------------------------------------------------------------------------------------------------------------------------------------------------------------------------------------------------------------------------------------------------------------------------------------------------------------------------------------------------------------------------------------------------------------------------------------------------------------------------------------------------------------------------------------------------------------------------------------------------------------------------------------------------------------------------------------------------------------------------------------------------------------------------------------------------------------

Room temperature unit(with on/off)-External sensor

<ul style="list-style-type: none"> KNX Secure General <ul style="list-style-type: none"> General setting Security setting Night mode setting Coordinates location setting Summer time setting Proximity setting Extension Sub Panel setting Advanced setting Home page Display view KNX Channel <ul style="list-style-type: none"> Channel 1... KNX Scene <ul style="list-style-type: none"> Internal temperature meas... HVAC controller <ul style="list-style-type: none"> Controller 1... Weekly timer function 	<p>Function Room temperature unit(with operation mode) ▾</p> <p>Function description (max 18 char.) <input type="text"/></p> <p>Function icon Heating/Cooling ▾</p> <p>Icon preview </p> <hr/> <p>Device online status reference by Individual ▾</p> <p>Period for request device online status [1...255] <input type="text" value="10"/> min</p> <hr/> <p>Controller from <input checked="" type="radio"/> Local <input type="radio"/> Bus</p> <p>Interface display temperature <input type="radio"/> Setpoint temperature <input checked="" type="radio"/> Actual temperature</p> <p>Room temperature reference from <input type="radio"/> Internal sensor <input checked="" type="radio"/> External sensor</p> <p>Period for request external sensor [0...255] <input type="text" value="10"/> min</p> <hr/> <p>Object datatype of setpoint adjustment <input type="radio"/> 1bit (DPT_1.007) <input checked="" type="radio"/> 2byte (DPT_9.001)</p> <p>Setpoint temperature adjustment step <input checked="" type="radio"/> 0.5K <input type="radio"/> 1K</p> <p>Min. setpoint temperature [5...37] <input type="text" value="10"/> °C</p> <p>Max. setpoint temperature [5...37] <input type="text" value="32"/> °C</p> <hr/> <p>Control mode Heating ▾</p> <p>Timer <input type="checkbox"/></p> <hr/> <p>Protection setting</p> <p>Setpoint protection <input type="checkbox"/></p> <p>Operation mode protection <input checked="" type="checkbox"/></p>
---------------------------------------------------------------------------------------------------------------------------------------------------------------------------------------------------------------------------------------------------------------------------------------------------------------------------------------------------------------------------------------------------------------------------------------------------------------------------------------------------------------------------------------------------------------------------------------------------------------------------------------------------------------------------------------------------------------------------------------------------------------------------------	--------------------------------------------------------------------------------------------------------------------------------------------------------------------------------------------------------------------------------------------------------------------------------------------------------------------------------------------------------------------------------------------------------------------------------------------------------------------------------------------------------------------------------------------------------------------------------------------------------------------------------------------------------------------------------------------------------------------------------------------------------------------------------------------------------------------------------------------------------------------------------------------------------------------------------------------------------------------------------------------------------------------------------------------------------------------------------------------------------------------------------------------------------------------------------------------------------------------------------------------------------------------------------------------------------------------------------------------------------------------------------------------------------------------------------------------------------------------------------------------------------------------------------------------------------------------------------------------------------------------------------------------------------------------------------------------------------------------------------------------------------------------------------------------------------------------------------------------------------------------------------------------

Room temperature unit(with operation mode)-External sensor

<ul style="list-style-type: none"> KNX Secure General <ul style="list-style-type: none"> General setting Security setting Night mode setting Coordinates location setting Summer time setting Proximity setting Extension Sub Panel setting Advanced setting Home page Display view KNX Channel <ul style="list-style-type: none"> Channel 1-... KNX Scene <ul style="list-style-type: none"> Internal temperature meas... HVAC controller <ul style="list-style-type: none"> Controller 1-... Weekly timer function 	<p>Function: Room temperature unit(with on/off & operation mode)</p> <p>Function description (max 18 char.):</p> <p>Function icon: Heating/Cooling</p> <p>Icon preview: </p> <hr/> <p>Device online status reference by: Individual</p> <p>Period for request device online status [1...255]: 10 min</p> <hr/> <p>Controller from: <input checked="" type="radio"/> Local <input type="radio"/> Bus</p> <p>Interface display temperature: <input type="radio"/> Setpoint temperature <input checked="" type="radio"/> Actual temperature</p> <p>Room temperature reference from: <input type="radio"/> Internal sensor <input checked="" type="radio"/> External sensor</p> <p>Period for request external sensor [0...255]: 10 min</p> <hr/> <p>Power on/off after download: <input type="radio"/> OFF <input checked="" type="radio"/> ON</p> <p>Power on/off after voltage recovery: Before voltage failure</p> <hr/> <p>Object datatype of setpoint adjustment: <input type="radio"/> 1bit (DPT_1.007) <input checked="" type="radio"/> 2byte (DPT_9.001)</p> <p>Setpoint temperature adjustment step: <input checked="" type="radio"/> 0.5K <input type="radio"/> 1K</p> <p>Min. setpoint temperature [5...37]: 10 °C</p> <p>Max. setpoint temperature [5...37]: 32 °C</p> <hr/> <p>Control mode: Heating</p> <p>Timer: <input type="checkbox"/></p>
-----------------------------------------------------------------------------------------------------------------------------------------------------------------------------------------------------------------------------------------------------------------------------------------------------------------------------------------------------------------------------------------------------------------------------------------------------------------------------------------------------------------------------------------------------------------------------------------------------------------------------------------------------------------------------------------------------------------------------------------------------------------------------------	-------------------------------------------------------------------------------------------------------------------------------------------------------------------------------------------------------------------------------------------------------------------------------------------------------------------------------------------------------------------------------------------------------------------------------------------------------------------------------------------------------------------------------------------------------------------------------------------------------------------------------------------------------------------------------------------------------------------------------------------------------------------------------------------------------------------------------------------------------------------------------------------------------------------------------------------------------------------------------------------------------------------------------------------------------------------------------------------------------------------------------------------------------------------------------------------------------------------------------------------------------------------------------------------------------------------------------------------------------------------------------------------------------------------------------------------------

<ul style="list-style-type: none"> Internal temperature me... HVAC controller <ul style="list-style-type: none"> Controller 1-... 	<p>Protection setting</p> <p>ON/OFF protection: <input type="checkbox"/></p> <p>Setpoint protection: <input type="checkbox"/></p> <p>Operation mode protection: <input checked="" type="checkbox"/></p>
---------------------------------------------------------------------------------------------------------------------------------------------------------------------------------------	----------------------------------------------------------------------------------------------------------------------------------------------------------------------------------------------------------------

Room temperature unit(with on/off & operation mode)-External sensor

<ul style="list-style-type: none"> KNX Secure - General <ul style="list-style-type: none"> General setting Security setting Night mode setting Coordinates location setting Summer time setting Proximity setting Extension Sub Panel setting Advanced setting Home page + Display view - KNX Channel <ul style="list-style-type: none"> + Channel 1-... + KNX Scene Internal temperature meas... - HVAC controller <ul style="list-style-type: none"> Controller 1-... + Weekly timer function 	<p>Function</p> <p>Function description (max 18 char.)</p> <p>Function icon</p> <p>Icon preview</p>  <hr/> <p>Device online status reference by</p> <p>Period for request device online status [1...255]</p> <p>Controller from</p> <p>Interface display temperature</p> <p>Room temperature reference from</p> <p>Period for request external sensor [0...255]</p> <p>Object datatype of setpoint adjustment</p> <p>Setpoint temperature adjustment step</p> <p>Min. setpoint temperature [5...37]</p> <p>Max. setpoint temperature [5...37]</p> <p>Control mode</p> <p>Timer</p> <hr/> <p>Protection setting</p> <p>Setpoint protection</p> <p>Operation mode protection</p> <p>Fan protection</p>	<p>Room temperature unit(with operation mode & fan speed)</p> <p>Heating/Cooling</p> <p>Individual</p> <p>10 min</p> <p>Local <input checked="" type="radio"/> Bus <input type="radio"/></p> <p>Setpoint temperature <input type="radio"/> Actual temperature <input checked="" type="radio"/></p> <p>Internal sensor <input type="radio"/> External sensor <input checked="" type="radio"/></p> <p>10 min</p> <p>1bit (DPT_1.007) <input type="radio"/> 2byte (DPT_9.001) <input checked="" type="radio"/></p> <p>0.5K <input checked="" type="radio"/> 1K <input type="radio"/></p> <p>10 °C</p> <p>32 °C</p> <p>Heating</p> <p><input type="checkbox"/></p> <hr/> <p><input type="checkbox"/></p> <p><input type="checkbox"/></p> <p><input type="checkbox"/></p>
<ul style="list-style-type: none"> - HVAC controller <ul style="list-style-type: none"> Controller 1-... + Weekly timer function 		

Room temperature unit(with operation mode & fan speed)-External sensor

<p>KNX Secure</p> <p>General</p> <ul style="list-style-type: none"> General setting Security setting Night mode setting Coordinates location setting Summer time setting Proximity setting Extension Sub Panel setting Advanced setting <p>Home page</p> <p>Display view</p> <p>KNX Channel</p> <p>Channel 1-...</p> <p>KNX Scene</p> <p>Internal temperature meas...</p> <p>HVAC controller</p> <p>Controller 1-...</p> <p>Weekly timer function</p> <p>KNX Scene</p> <p>Internal temperature meas...</p> <p>HVAC controller</p> <p>Controller 1-...</p>		<p>Function: Room temperature unit(with on/off & operation mode & fan speed)</p> <p>Function description (max 18 char.):</p> <p>Function icon: Heating/Cooling</p> <p>Icon preview: </p> <hr/> <p>Device online status reference by: Individual</p> <p>Period for request device online status [1...255]: 10 min</p> <hr/> <p>Controller from: <input checked="" type="radio"/> Local <input type="radio"/> Bus</p> <p>Interface display temperature: <input type="radio"/> Setpoint temperature <input checked="" type="radio"/> Actual temperature</p> <p>Room temperature reference from: <input type="radio"/> Internal sensor <input checked="" type="radio"/> External sensor</p> <p>Period for request external sensor [0...255]: 10 min</p> <hr/> <p>Power on/off after download: <input type="radio"/> OFF <input checked="" type="radio"/> ON</p> <p>Power on/off after voltage recovery: Before voltage failure</p> <hr/> <p>Object datatype of setpoint adjustment: <input type="radio"/> 1bit (DPT_1.007) <input checked="" type="radio"/> 2byte (DPT_9.001)</p> <p>Setpoint temperature adjustment step: <input checked="" type="radio"/> 0.5K <input type="radio"/> 1K</p> <p>Min. setpoint temperature [5...37]: 10 °C</p> <p>Max. setpoint temperature [5...37]: 32 °C</p> <hr/> <p>Control mode: Heating</p> <p>Timer: <input type="checkbox"/></p> <hr/> <p>Protection setting</p> <p>ON/OFF protection: <input type="checkbox"/></p> <p>Setpoint protection: <input type="checkbox"/></p> <p>Operation mode protection: <input type="checkbox"/></p> <p>Fan protection: <input type="checkbox"/></p>
------------------------------------------------------------------------------------------------------------------------------------------------------------------------------------------------------------------------------------------------------------------------------------------------------------------------------------------------------------------------------------------------------------------------------------------------------------------------------------------------------------------------------------------------------------------------------------------------------------------------------------------------	--	---------------------------------------------------------------------------------------------------------------------------------------------------------------------------------------------------------------------------------------------------------------------------------------------------------------------------------------------------------------------------------------------------------------------------------------------------------------------------------------------------------------------------------------------------------------------------------------------------------------------------------------------------------------------------------------------------------------------------------------------------------------------------------------------------------------------------------------------------------------------------------------------------------------------------------------------------------------------------------------------------------------------------------------------------------------------------------------------------------------------------------------------------------------------------------------------------------------------------------------------------------------------------------------------------------------------------------------------------------------------------------------------------------------------------------------------------------------------------------------------------------------------------------------------------------------------------------------------------------------------------------------------------------------------------------------------------------------------------

Room temperature unit(with on/off & operation mode & fan speed)-External sensor

图 5.11.2(8) 温控功能参数设置



图 5.11.2.1(9) Fan 参数设置

参数“Controller from”

此参数设置控制器是本地还是外部。如果选择本地，则上电启动或总线恢复时不需要发送设置温度、控制模式、操作模式的读请求(因为本设备不能回应自己发出的请求)。可选项：

Local

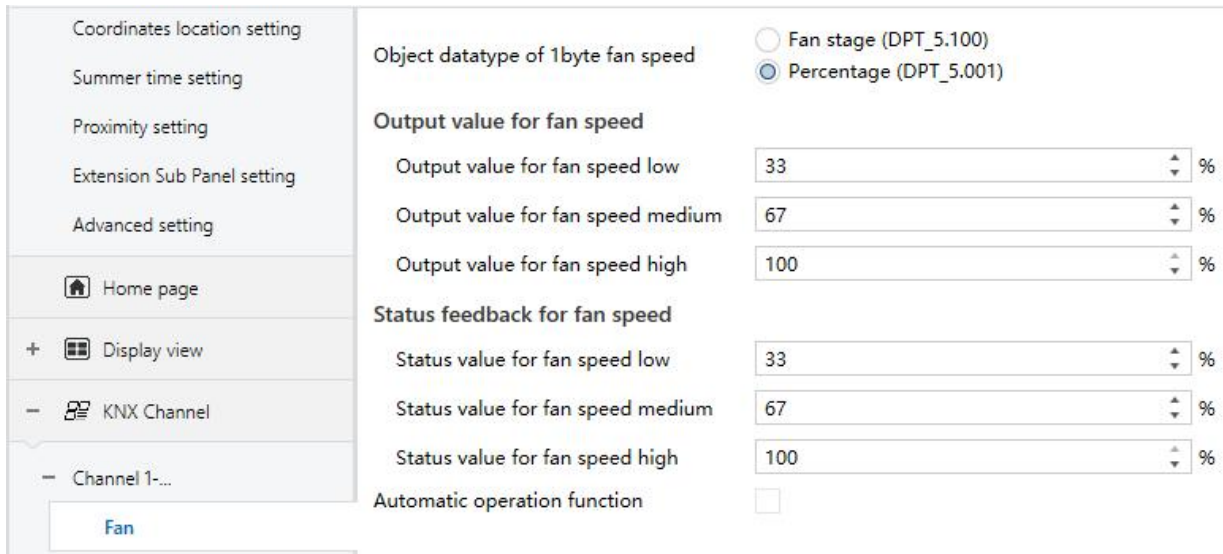
Bus

参数“Interface display temperature”

此参数设置常态下界面的显示温度。可选项：

Setpoint temperature 设定温度

Actual temperature 室内温度

注意：如果显示室内温度，第一次操作温度加减按钮只是切换为设置温度显示，不发送报文。

——参数“Room temperature reference from”

上个参数选择“Actual temperature”时可见。此参数设置空调功能的温度参照来源。可选项：

Internal sensor 内部传感器**External sensor 外部传感器****——参数“Period for request external sensor [0...255]min”**

选择“External sensor”时，此参数可见。设置设备向外部温度传感器发送读请求房间温度的时间周期。

可选项：**0..255**

注意：在设备重启时，默认会发送读请求。

参数“Object datatype of setpoint adjustment”

此参数设置设定温度的调整方式。可选项：

1bit (DPT_1.007)

2byte (DPT_9.001)

参数“Setpoint temperature adjustment step”

选择“2byte (DPT_9.001)”时，此参数可见。设置温度设定值的步进值。可选项：

0.5K

1K

参数“Min/Max. setpoint temperature [5..37]° C”

用于限制温度设定值的可调节范围。设置的最小值需小于最大值。温度设定值超出限值范围，则按限值输出。可选项：**5...37**

参数“Control mode”

此参数用于设置 RTC 的控制模式。可选项：

Heating

Cooling

Heating and Cooling

参数“Timer”

此参数设置是否使能定时开关功能，使能后显示相应的对象，且用户可在屏上设置自定义定时。

注意：总线只可临时关闭定时功能。

Protection setting 保护设置

参数“ON/OFF protection”

参数“Setpoint protection”

参数“Control mode protection”

参数“Operation mode protection”

参数“Fan protection”

这些参数设置是否使能功能保护，即某些功能只是显示，不让用户操作。保护功能支持开关、设定值、模式、风速控制和扫风控制。

对于功能保护，只针对用户不能操作屏或快捷键，但仍会处理接收的数据。

这部分参数的显示条件注意：

- 1.带 on/off 的温控类型才会显示 ON/OFF 保护的参数
- 2.Control mode 保护需要选择 Heating and Cooling 时可见；
- 3.带 operation mode 的温控类型才会显示 Operation mode 保护的参数
- 4.带 fan speed 的温控类型才会显示 Fan 保护的参数

以下参数仅在功能选择 **Room temperature unit(with on/off)**或 **Room temperature unit(with on/off & operation mode)**或 **Room temperature unit(with on/off & operation mode & fan speed)**时可见。

参数“Power on/off after download”

此参数设置在应用程序下载后温控界面的开关状态。可选项：

OFF

ON

参数“Power on/off after voltage recovery”

此参数设置在设备上电复位后温控界面的开关状态。可选项：

OFF 关

ON 开

Before voltage failure 掉电前的模式状态

OFF：设备在上电时将为关机状态，此时除开关图标外，其它界面图标不可操作；

ON：设备在上电时将为开机状态，此时界面可操作；

Before voltage failure：设备在上电时温控界面将恢复到掉电前的开关状态。

以下参数仅在功能选择“**Room temperature unit(with operation mode & fan speed)**”和“**Room temperature unit(with on/off & operation mode & fan speed)**”时可见。如图 5.11.2.1(8)所示。

参数“Object datatype of 1byte fan speed”

此参数用于设置 1byte 风速对象的数据类型。可选项：

Fan stage (DPT 5.100)

Percentage (DPT 5.001)

Output value for fan speed 风速输出值

参数“Output value for fan speed low/medium/high”

这些参数设置切换到各个风速挡位的输出值，支持低、中、高 4 种风速。可选项根据上一个参数的

对象类型显示：**0..255/0..100**

Status feedback for fan speed 风速状态反馈

参数“Status value for fan speed low/medium/high”

这些参数设置各风速挡位的状态反馈值，支持低、中、高 4 种风速。设备将根据反馈值进行风速更

新显示。可选项根据上一个参数的对象类型显示：**0..255/0..100**

参数“Automatic operation function”

此参数用于设置启用风速的自动控制，使能后显示相应的对象。

5.11.2.9.新风功能

<ul style="list-style-type: none"> Summer time setting Proximity setting Extension Sub Panel setting Advanced setting Home page Display view KNX Channel Channel 1-... KNX Scene Internal temperature meas... HVAC controller Controller 1-... <ul style="list-style-type: none"> Setpoint Heating/Cooling control Fan auto.control Human Centric Lighting(H... Weekly timer function Alarm function <ul style="list-style-type: none"> Alarm 1-... Alarm 2-... Alarm 3-... Alarm 4-... Alarm 5-... 	<p>Function: Ventilation system</p> <p>Function description (max 18 char.): <input type="text"/></p> <p>Function icon: Ventilation</p> <p>Icon preview: </p> <hr/> <p>Device online status reference by: Individual</p> <p>Period for request device online status [1...255]: 10 min</p> <hr/> <p>Power on/off after download: <input type="radio"/> OFF <input checked="" type="radio"/> ON</p> <p>Power on/off after voltage recovery: Before voltage failure</p> <p>Default fan speed after ventilation on: Low</p> <hr/> <p>Object datatype of 1byte fan speed: <input checked="" type="radio"/> Fan stage (DPT_5.100) <input type="radio"/> Percentage (DPT_5.001)</p> <p>Output value for fan speed</p> <p>Output value for fan speed low: 1</p> <p>Output value for fan speed medium: 2</p> <p>Output value for fan speed high: 3</p> <p>Status feedback for fan speed</p> <p>Status value for fan speed low: 1</p> <p>Status value for fan speed medium: 2</p> <p>Status value for fan speed high: 3</p> <hr/> <p>Heat recovery function: <input checked="" type="checkbox"/></p> <p>Filter timer counter: <input checked="" type="checkbox"/></p> <p>Evaluation time [100...10000]: 1000 h</p>
----------------------------------------------------------------------------------------------------------------------------------------------------------------------------------------------------------------------------------------------------------------------------------------------------------------------------------------------------------------------------------------------------------------------------------------------------------------------------------------------------------------------------------------------------------------------------------------------------------------------------------------------------------------------------------------------------------------------------------------------------------------	--------------------------------------------------------------------------------------------------------------------------------------------------------------------------------------------------------------------------------------------------------------------------------------------------------------------------------------------------------------------------------------------------------------------------------------------------------------------------------------------------------------------------------------------------------------------------------------------------------------------------------------------------------------------------------------------------------------------------------------------------------------------------------------------------------------------------------------------------------------------------------------------------------------------------------------------------------------------------------------------------------------------------------------------------------------------------------------------------------------------------------------------------------------------------------------------------------------------------------------------------------------------------------------------------------------------------------------------------------------------------------------------------------------------------------------------------------------------------------------------------------------------------------------------------------------------------------------------------------------------------------------------------------------------------------------------------------------------------------------------------------------------------------------------------------------------------------------------------------------------------------------------------------------------------------------------------------------------------------------------------------------------------------------------------------------------------------------------------------

Ventilation system

<ul style="list-style-type: none"> KNX Secure General <ul style="list-style-type: none"> General setting Security setting Night mode setting Coordinates location setting Summer time setting Proximity setting Extension Sub Panel setting Advanced setting Home page Display view KNX Channel <ul style="list-style-type: none"> Channel 1... KNX Scene <ul style="list-style-type: none"> Internal temperature meas... HVAC controller <ul style="list-style-type: none"> Controller 1... Weekly timer function 	<p>Function: Ventilation system(with auto fan speed)</p> <p>Function description (max 18 char.):</p> <p>Function icon: Ventilation</p> <p>Icon preview: </p> <p>Device online status reference by: Always online</p> <p>Power on/off after download: <input type="radio"/> OFF <input checked="" type="radio"/> ON</p> <p>Power on/off after voltage recovery: Before voltage failure</p> <p>Default fan speed after ventilation on: Low</p> <p>Object datatype of 1byte fan speed: <input type="radio"/> Fan stage (DPT_5.100) <input checked="" type="radio"/> Percentage (DPT_5.001)</p> <p>Output value for fan speed</p> <p>Output value for fan speed low: 33 %</p> <p>Output value for fan speed medium: 67 %</p> <p>Output value for fan speed high: 100 %</p> <p>Status feedback for fan speed</p> <p>Status value for fan speed low: 33 %</p> <p>Status value for fan speed medium: 67 %</p> <p>Status value for fan speed high: 100 %</p> <p>Heat recovery function: <input checked="" type="checkbox"/></p> <p>Filter timer counter: <input checked="" type="checkbox"/></p> <p>Evaluation time [100...10000]: 1000 h</p> <p>Air Quality value reference from: PM2.5</p> <p>Object datatype of PM2.5: <input checked="" type="radio"/> Value in ug/m3(DPT_7.001) <input type="radio"/> Float value in ug/m3(DPT_9.030)</p>
-------------------------------------------------------------------------------------------------------------------------------------------------------------------------------------------------------------------------------------------------------------------------------------------------------------------------------------------------------------------------------------------------------------------------------------------------------------------------------------------------------------------------------------------------------------------------------------------------------------------------------------------------------------------------------------------------------------------------------------------------------------------------	--------------------------------------------------------------------------------------------------------------------------------------------------------------------------------------------------------------------------------------------------------------------------------------------------------------------------------------------------------------------------------------------------------------------------------------------------------------------------------------------------------------------------------------------------------------------------------------------------------------------------------------------------------------------------------------------------------------------------------------------------------------------------------------------------------------------------------------------------------------------------------------------------------------------------------------------------------------------------------------------------------------------------------------------------------------------------------------------------------------------------------------------------------------------------------------------------------------------------------------------------------------------------------------------------------------------------------------------------------------------------------------------------------------------------

Ventilation system(with auto fan speed)

图 5.11.2(10) 新风功能参数设置界面

参数“Power on/off after download”

此参数设置在应用程序下载后新风界面的开关状态。可选项：

OFF

ON

参数“Power on/off after voltage recovery”

此参数设置在设备上电复位后新风界面的开关状态。可选项：

OFF 关

ON 开

Before voltage failure 掉电前的模式状态

OFF：设备在上电时将为关机状态，此时除滤网重置、开关图标外，其它界面图标不可操作；

ON：设备在上电时将为开机状态，此时界面可操作；

Before voltage failure：设备在上电时新风界面将恢复到掉电前的开关状态。

参数“Default fan speed after ventilation on”

设置新风打开时的初始风速。可选项：

Low

Medium

High

Last status 保持上一个状态

参数“Object datatype of 1byte fan speed”

此参数用于设置 1byte 风速对象的数据类型。可选项：

Fan stage (DPT 5.100)

Percentage (DPT 5.001)

Output value for fan speed 风速输出值

参数“Output value for fan speed low/medium/high”

这些参数设置切换到各个风速挡位的输出值，支持低、中、高 4 种风速。可选项根据上一个参数的

对象类型显示：**0..255/0..100**

Status feedback for fan speed 风速状态反馈

参数“Status value for fan speed low/medium/high”

这些参数设置各风速挡位的状态反馈值，支持低、中、高 4 种风速。设备将根据反馈值进行风速更

新显示。可选项根据上一个参数的对象类型显示：**0..255/0..100**

参数“Heat recovery function”

此参数设置是否使能热交换功能，使能后显示相应的对象。

参数“Filter timer counter”

此参数设置是否使能滤网使用计时功能，使能后显示相应的对象和设置参数。

——参数“Evaluation time [100..10000]h”

此参数设置滤网使用的寿命时长。可选项：**100..10000**

若滤网使用时长超出设置时间，滤网将发出报警，提示清洗滤网。

滤网使用时长可通过对象“Filter timer reset”重置。

滤网使用时长可通过对象“Filter timer counter”进行计数，计数时长以小时为单位，当计数值改变时发送到总线上，也可通过对象“Filter timer counter change”从总线上修改滤网的计数时长。

以下参数在功能选择 **Ventilation system(with auto fan speed)** 时可见。

此处值用于屏幕界面显示当前参考值的数据。

参数“Air Quality value reference from”

此参数设置自动操作下，显示的传感器值。可选项：

PM2.5

CO2

VOC

参数“Object datatype of PM2.5”

此参数设置 PM2.5 的数据点类型。可选项：

Value in ug/m3(DPT_7.001)

Float value in ug/m3(DPT_9.030)

参数“Object datatype of VOC”

此参数设置 VOC 值的数据点类型。可选项：

Value in ug/m3(DPT_7.001)

Float value in ug/m3(DPT_9.030)

参数“Object datatype of CO2”

此参数设置 CO2 值的数据点类型。可选项：

Value in ppm(DPT_7.001)

Float value in ppm(DPT_9.008)

5.11.2.10.背景音乐功能

<ul style="list-style-type: none"> KNX Secure General <ul style="list-style-type: none"> General setting Security setting Night mode setting Coordinates location setting Summer time setting Proximity setting Extension Sub Panel setting Advanced setting Home page Display view KNX Channel 	Function	Audio control
	Function description (max 18 char.)	
	Function icon	Music 1
	Icon preview	
	Device online status reference by	Always online
	Number of object for play/pause control	<input checked="" type="radio"/> 1 <input type="radio"/> 2
	Number of object for next/previous track control	<input checked="" type="radio"/> 1 <input type="radio"/> 2
	Object datatype of volume	<input checked="" type="radio"/> Percentage (DPT_5.001) <input type="radio"/> Percentage (DPT_5.004)
	Max. volume value [10..100]	100 %
	Mute	<input checked="" type="checkbox"/>

Audio control

<ul style="list-style-type: none"> KNX Secure General <ul style="list-style-type: none"> General setting Security setting Night mode setting Coordinates location setting Summer time setting Proximity setting Extension Sub Panel setting Advanced setting Home page Display view KNX Channel 	Function	Audio control(with on/off)
	Function description (max 18 char.)	
	Function icon	Music 1
	Icon preview	
	Device online status reference by	Common 2
	Power on/off status after download	<input checked="" type="radio"/> OFF <input type="radio"/> ON
	Power on/off status after voltage recovery	Before voltage failure
	Number of object for play/pause control	<input checked="" type="radio"/> 1 <input type="radio"/> 2
	Number of object for next/previous track control	<input checked="" type="radio"/> 1 <input type="radio"/> 2
	Mute	<input type="checkbox"/>

Audio control(with on/off)

KNX Secure

General

General setting

Security setting

Night mode setting

Coordinates location setting

Summer time setting

Proximity setting

Extension Sub Panel setting

Advanced setting

Home page

Display view

KNX Channel

Channel 1-...

Channel 2-...

Channel 3-...

Channel 4-...

Channel 5-...

Channel 6-...

KNX Scene

Function: Audio control(play mode)

Function description (max 18 char.):

Function icon: Music 1

Icon preview: 

Device online status reference by: Common 2

Number of object for play/pause control: 1 2

Number of object for next/previous track control: 1 2

Mute:

Play mode setting

Play in single cycle mode:

Output value for play in single cycle: 1

Status value for play in single cycle: 1

Play in order mode:

Output value for play in order: 2

Status value for play in order: 2

Play in random mode:

Output value for play in random: 3

Status value for play in random: 3

Audio control(play mode)

<ul style="list-style-type: none"> KNX Secure General <ul style="list-style-type: none"> General setting Security setting Night mode setting Coordinates location setting Summer time setting Proximity setting Extension Sub Panel setting Advanced setting Home page Display view KNX Channel 	Function	Audio control(track information)
	Function description (max 18 char.)	
	Function icon	Music 1
	Icon preview	
	Device online status reference by	Common 2
	Number of object for play/pause control	<input checked="" type="radio"/> 1 <input type="radio"/> 2
	Number of object for next/previous track control	<input checked="" type="radio"/> 1 <input type="radio"/> 2
	Object datatype of volume	<input checked="" type="radio"/> Percentage (DPT_5.001) <input type="radio"/> Percentage (DPT_5.004)
	Max. volume value [10...100]	100 %
	Mute	<input type="checkbox"/>

Audio control(track information)

<ul style="list-style-type: none"> KNX Secure General <ul style="list-style-type: none"> General setting Security setting Night mode setting Coordinates location setting Summer time setting Proximity setting Extension Sub Panel setting Advanced setting Home page Display view KNX Channel 	Function	Audio control(track information & playlist)
	Function description (max 18 char.)	
	Function icon	Music 1
	Icon preview	
	Device online status reference by	Common 2
	Number of object for play/pause control	<input checked="" type="radio"/> 1 <input type="radio"/> 2
	Number of object for next/previous track control	<input checked="" type="radio"/> 1 <input type="radio"/> 2
	Object datatype of volume	<input checked="" type="radio"/> Percentage (DPT_5.001) <input type="radio"/> Percentage (DPT_5.004)
	Max. volume value [10...100]	100 %
	Mute	<input type="checkbox"/>

Audio control(track information+playlist)

图 5.11.2(11) 背景音乐功能参数设置界面

参数“Number of object for play/pause control”

此参数设置控制播放/暂停的对象数量，共用 1 个对象或者独立 2 个对象。可选项：

1

2

参数“Number of object for next/previous track control”

此参数设置播放下一曲/上一曲的对象数量，共用 1 个对象或者独立 2 个对象。可选项：

1

2

参数“Mute”

此参数设置是否使能静音功能。

以下参数在功能选择“Audio control(with on/off)”时可见。

参数“Power on/off status after download”

此参数设置在应用程序下载后背景音乐界面的开关状态。可选项：

OFF

ON

参数“Power on/off status after voltage recovery”

此参数设置在设备上电复位后背景音乐界面的开关状态。可选项：

OFF 关

ON 开

Before voltage failure 掉电前的模式状态

OFF：设备在上电时将为关机状态，此时界面图标不可操作；

ON：设备在上电时将为开机状态，此时界面可操作；

Before voltage failure: 设备在上电时背景音乐界面将恢复到掉电前的开关状态。

以下参数在功能选择“**Audio control/Audio control(track information)/Audio control(track information+playlist)**”时可见。

参数“Object datatype of volume”

此参数设置音量的对象数据类型。可选项：

Percentage (DPT_5.001)

Percentage (DPT_5.004)

参数“Max. volume value [10..100] %”

此参数设置可调节的最大音量。可选项：**10..100**

以下参数在功能选择“**Audio control(play mode)**”时可见。

Play mode setting 播放模式设置

参数“Play in single cycle mode”

此参数设置是否使能单曲循环功能。使能后显示以下两个参数。

——参数“**Output value for play in single cycle**”

此参数用于设置单曲循环的控制值。可选项：**0..255**

——参数“**Status value for play in single cycle**”

此参数用于设置单曲循环的状态值。设备将根据反馈值进行播放模式更新显示。可选项：**0..255**

参数“Play in order mode”

此参数设置是否使能顺序播放功能。使能后显示以下两个参数。

——参数“**Output value for play in order**”

此参数设置顺序播放的控制值。可选项：**0..255**

——参数“**Status value for play in order**”

此参数设置顺序播放的状态值。设备将根据反馈值进行播放模式更新显示。可选项：**0..255**

参数“**Play in random mode**”

此参数设置是否使能随机播放功能。使能后显示以下两个参数。

——参数“**Output value for play in random**”

此参数设置随机播放的控制值。可选项：**0..255**

——参数“**Status value for play in random**”

此参数设置随机播放的状态值。可选项：**0..255**

5.11.2.11.能源检测功能

能源检测功能参数设置界面如图 5.11.2(12)所示,用于设置能源检测值显示的功能,可以设置电流、电压、功率、和能量的显示。

<ul style="list-style-type: none"> KNX Secure - General <ul style="list-style-type: none"> General setting Security setting Night mode setting Coordinates location setting Summer time setting Proximity setting Extension Sub Panel setting Advanced setting Home page + Display view - KNX Channel 	Function	Energy metering(power & energy)
	Function description (max 18 char.)	
	Function icon	Energy
	Icon preview	
	Device online status reference by	Individual
	Period for request device online status [1...255]	10 min
	Object datatype of power	<input checked="" type="radio"/> Float value in kW (DPT 9.024) <input type="radio"/> Float value in W (DPT 14.056)
	Object datatype of energy	<input type="radio"/> Value in Wh (DPT 13.010) <input checked="" type="radio"/> Value in kWh (DPT 13.013)
	Period for request meter value [0...255]	1 min

Energy metering(power & energy)

<ul style="list-style-type: none"> KNX Secure + General Home page + Display view - KNX Channel <ul style="list-style-type: none"> Channel 1-... Channel 2-... Channel 3-... Channel 4-... Channel 5-... Channel 6-... + KNX Scene 	Function	Energy metering(power & energy & current)
	Function description (max 18 char.)	
	Function icon	Energy
	Icon preview	
	Device online status reference by	Common 2
	Object datatype of current	Float value in mA (DPT 9.021)
	Object datatype of power	<input checked="" type="radio"/> Float value in kW (DPT 9.024) <input type="radio"/> Float value in W (DPT 14.056)
	Object datatype of energy	<input type="radio"/> Value in Wh (DPT 13.010) <input checked="" type="radio"/> Value in kWh (DPT 13.013)
	Period for request meter value [0...255]	0 min

Energy metering(power & energy & current)

<ul style="list-style-type: none"> KNX Secure + General Home page + Display view - KNX Channel Channel 1-... Channel 2-... Channel 3-... Channel 4-... Channel 5-... Channel 6-... + KNX Scene Internal temperature meas... 	Function	Energy metering(power & energy & current & voltage)
	Function description (max 18 char.)	
	Function icon	Energy
	Icon preview	
	Device online status reference by	Common 2
	Object datatype of current	Float value in mA (DPT 9.021)
	Object datatype of voltage	<input type="radio"/> Float value in mV (DPT 9.020) <input checked="" type="radio"/> Float value in V (DPT 14.027)
	Object datatype of power	<input checked="" type="radio"/> Float value in kW (DPT 9.024) <input type="radio"/> Float value in W (DPT 14.056)
	Object datatype of energy	<input type="radio"/> Value in Wh (DPT 13.010) <input checked="" type="radio"/> Value in kWh (DPT 13.013)
	Period for request meter value [0...255]	0 min

Energy metering(power & energy & current & voltage)

图 5.11.2(12) 能源检测功能参数设置界面

参数“Object datatype of power”

此参数设置电源显示项的数据类型。可选项：

Float value in kW (DPT 9.024)

Float value in W (DPT 14.056)

参数“Object datatype of energy”

此参数设置能源显示项的数据类型。可选项：

Value in Wh (DPT 13.010)

Value in kWh (DPT 13.013)

参数“Period for request meter value [0...255]min”

此参数设置设备向外部测量执行器发送读请求测量值的时间周期。可选项：**0...255**

以下参数在功能选择“Energy metering(power & energy & current)或 Energy metering(power & energy & current & voltage)”时可见。

参数“Object datatype of current”

此参数设置电流显示项的数据类型。可选项：

Value in mA (DPT 7.012)

Float value in mA (DPT 9.021)

Float value in A (DPT 14.019)

以下参数在功能选择“Energy metering(power & energy & current & voltage)”时可见。

参数“Object datatype of voltage”

此参数设置电压显示项的数据类型。可选项：

Float value in mV (DPT 9.020)

Float value in V (DPT 14.027)

5.11.2.12.温度/湿度传感器功能

<ul style="list-style-type: none"> KNX Secure + General Home page + Display view - KNX Channel Channel 1-... Channel 2-... Channel 3-... Channel 4-... Channel 5-... Channel 6-... + KNX Scene 	Function	Temperature sensor
	Function description (max 18 char.)	
	Function icon	Temperature 1
	Icon preview	
	Device online status reference by	Common 2
	Period for request external sensor [0...255]	0 min
	Alarm	<input checked="" type="checkbox"/>
	Threshold value for low temperature alarm [0...15]	0 °C
	Threshold value for high temperature alarm [30...45]	45 °C

Temperature sensor

<ul style="list-style-type: none"> KNX Secure + General Home page + Display view - KNX Channel Channel 1-... Channel 2-... Channel 3-... Channel 4-... Channel 5-... Channel 6-... + KNX Scene 	Function	Humidity sensor
	Function description (max 18 char.)	
	Function icon	Humidity
	Icon preview	
	Device online status reference by	Common 2
	Period for request external sensor [0...255]	0 min
Alarm	<input checked="" type="checkbox"/>	
Threshold value for low humidity alarm [5...20]	5 %	
Threshold value for high humidity alarm [70...85]	85 %	

Humidity sensor

图 5.11.2(13) 温湿度传感器功能参数设置界面

参数“Alarm”

此参数设置是否使能报警功能。适用于 Temperature sensor, Humidity sensor, VOC, PM2.5 sensor, PM10 sensor, AQI sensor, CO2 sensor

参数“Threshold for low temperature alarm [0...15]”

此参数设置低温报警阈值。当温度低于低阈值时，低温警报对象发出警报。可选项：

0°C

1°C

...

15°C

参数“Threshold for high temperature alarm [30...45]”

此参数设置高温报警阈值。当温度高于高阈值时，高温报警对象发出警报。可选项：

30°C

31°C

...

45°C

参数“Threshold for low humidity alarm [5...20] %”

此参数设置低湿报警阈值。当湿度低于低阈值时，低湿报警对象发出警报。可选项：**5..20**

参数“Threshold for high humidity alarm [70...85] %”

此参数设置高湿报警阈值。当湿度高于高阈值时，高湿报警对象发出警报。可选项：**70..85**

参数“Period for request external sensor [0...255] min”

此参数用于设置设备向外部温度传感器发送读请求的时间周期。上电复位和编程完成默认发送读请求，0 时不发送。可选项：**0..255**

5.11.2.13. 环境状态传感器检测功能

参数设置界面“环境状态传感器检测功能”如图 5.11.2(14)所示，用于设置空气质量显示的功能，可以设置 PM2.5、PM10、VOC、AQI、CO2、风速、光照度的显示。

KNX Secure

General

General setting

Security setting

Night mode setting

Coordinates location setting

Summer time setting

Proximity setting

Extension Sub Panel setting

Advanced setting

Home page

Display view

KNX Channel

Channel 1...

KNX Scene

Function: PM2.5 sensor

Function description (max 18 char.):

Function icon: PM2.5

Icon preview: 

Device online status reference by: Individual

Period for request device online status [1...255]: 10 min

Object datatype of PM2.5: Value in ug/m3(DPT_7.001) Float value in ug/m3(DPT_9.030)

Text for unit:

Period for request external sensor [0...255]: 0 min

Monitoring level indication:

Alarm:

PM2.5 alarm value [100...999]: 150 ug/m3

PM2.5 sensor

KNX Secure

General

Home page

Display view

KNX Channel

Channel 1...

Channel 2...

Channel 3...

Channel 4...

Channel 5...

Channel 6...

KNX Scene

Internal temperature meas...

Function: PM10 sensor

Function description (max 18 char.):

Function icon: PM10

Icon preview: 

Device online status reference by: Common 2

Object datatype of PM10: Value in ug/m3(DPT_7.001) Float value in ug/m3(DPT_9.030)

Text for unit:

Period for request external sensor [0...255]: 0 min

Monitoring level indication:

Alarm:

PM10 alarm value [100...999]: 150 ug/m3

PM10 sensor

KNX Secure
 General
 Home page
 Display view
 KNX Channel

 Channel 1-...
 Channel 2-...
 Channel 3-...
 Channel 4-...
 Channel 5-...
 Channel 6-...

 KNX Scene
 Internal temperature meas...

Function: VOC sensor
 Function description (max 18 char.):
 Function icon: VOC
 Icon preview: 

Device online status reference by: Common 2

Object datatype of VOC: Value in ug/m3(DPT_7.001) Float value in ug/m3(DPT_9.030)

Text for unit:
 Period for request external sensor [0...255]: 0 min

Alarm:
 VOC alarm value [100...900]: 500 ug/m3

VOC sensor

KNX Secure
 General
 Home page
 Display view
 KNX Channel

 Channel 1-...
 Channel 2-...
 Channel 3-...
 Channel 4-...
 Channel 5-...
 Channel 6-...

 KNX Scene
 Internal temperature meas...

Function: AQI sensor
 Function description (max 18 char.):
 Function icon: AQI
 Icon preview: 

Device online status reference by: Common 2

Text for unit:
 Period for request external sensor [0...255]: 0 min

Monitoring level indication:

Alarm:
 AQI alarm value [100...500]: 200

AQI sensor

<ul style="list-style-type: none"> KNX Secure + General Home page + Display view - KNX Channel Channel 1-... Channel 2-... Channel 3-... Channel 4-... Channel 5-... Channel 6-... + KNX Scene Internal temperature meas... 	Function	CO2 sensor
	Function description (max 18 char.)	
	Function icon	CO2
	Icon preview	
	Device online status reference by	Common 2
	Object datatype of CO2	<input type="radio"/> Value in ppm(DPT_7.001) <input checked="" type="radio"/> Float value in ppm(DPT_9.008)
	Text for unit	
	Period for request external sensor [0...255]	0 min
	Monitoring level indication	<input type="checkbox"/>
	Alarm	<input checked="" type="checkbox"/>
CO2 alarm value [1000...5000]	2000 ppm	

CO2 sensor

<ul style="list-style-type: none"> KNX Secure + General Home page + Display view - KNX Channel Channel 1-... Channel 2-... Channel 3-... Channel 4-... Channel 5-... Channel 6-... + KNX Scene Internal temperature measur... 	Function	Wind sensor
	Function description (max 18 char.)	
	Function icon	Wind speed
	Icon preview	
	Device online status reference by	Common 2
	Object datatype of wind speed	<input checked="" type="radio"/> Float value in m/s(DPT_9.005) <input type="radio"/> Float value in km/h(DPT_9.028)
	Text for unit	
	Period for request external sensor [0...255]	0 min
	Alarm	<input checked="" type="checkbox"/>
	Wind alarm value [5...50]	20 m/s

Wind sensor

Brightness sensor

图 5.11.2(14) 环境状态传感器检测功能

参数“Text for unit”

此参数设置自定义文本，默认值为空时单位由数据点类型决定。

参数“Period for request external sensor [0...255]min”

此参数用于设置设备向外部温度传感器发送读请求的时间周期。上电复位和编程完成默认发送读请求，

0 时不发送。可选项：**0..255**

参数“Monitoring level indication”

此参数仅在功能选择“PM2.5 sensor”，“PM10 sensor”，“AQI sensor”，“CO2 sensor”时可见。

此参数设置是否启用监测等级指示，使图标根据数值的变化显示不同颜色。

详细配置方式请查看章节 5.11。

以下参数在功能选择“PM2.5 sensor”时可见。

参数“Object datatype of PM2.5”

此参数设置 PM2.5 对象的数据类型。可选项：

Value in ug/m3(DPT_7.001)

Float value in ug/m3(DPT_9.030)

参数“Alarm”

此参数设置是否使能 PM2.5 报警信号。

——参数“PM2.5 alarm value [100....999]ug/m3”

当上个参数使能时可见。此参数设置 PM2.5 报警阈值。当 PM2.5 超出阈值时，PM2.5 警报对象发出警报值。可选项：**100...999**

以下参数在功能选择“PM10 sensor”时可见。

参数“Object datatype of PM10”

此参数设置 PM10 对象的数据类型。可选项：

Value in ug/m3 (DPT 7.001)

Float value in ug/m3 (DPT 9.030)

参数“Alarm”

此参数设置是否使能 PM10 报警信号。

——参数“PM10 alarm value [100....999]ug/m3”

当上个参数使能时可见。此参数设置 PM10 报警阈值。当 PM10 超出阈值时，PM10 警报对象发出警报值。可选项：**100...999**

以下参数在功能选择“VOC sensor”时可见。

参数“Object datatype of VOC”

此参数设置 VOC 对象的数据类型。可选项：

Value in ug/m3 (DPT 7.001)

Float value in ug/m3 (DPT 9.030)

参数“Alarm”

此参数设置是否使能 VOC 报警信号。

——参数“VOC alarm value [100....900]ug/m3”

当上个参数使能时可见。此参数设置 VOC 报警阈值。当 VOC 超出阈值时，VOC 警报对象发出警报值。可选项：**100...900**

以下参数在功能选择“AQI sensor”时可见。

参数“Alarm”

此参数设置是否使能 AQI 报警信号。

——参数“AQI alarm value [100....500]”

当上个参数使能时可见。此参数设置 AQI 报警阈值。当 AQI 超出阈值时，AQI 警报对象发出警报值。

可选项：**100...500**

以下参数在功能选择“CO2 sensor”时可见。

参数“Object datatype of CO2”

此参数设置 CO2 对象的数据类型。可选项：

Value in ppm(DPT_7.001)

Float value in ppm(DPT_9.008)

参数“Alarm”

此参数设置是否使能 CO2 报警信号。

——参数“CO2 alarm value [1000....5000]ppm”

当上个参数使能时可见。此参数设置 CO2 报警阈值。当 CO2 超出阈值时，CO2 警报对象发出警报值。可选项：**1000...5000**

参数“Object datatype of brightness(lux)”

此参数设置光照度对象的数据类型。可选项：

Value in lux(DPT_7.013)

Float value in lux(DPT_9.004)

以下参数在功能选择“Wind sensor”时可见。

参数“Object datatype of wind speed”

此参数设置风速对象的数据类型。可选项：

Float value in m/s(DPT_9.005)

Float value in km/h(DPT_9.028)

参数“Alarm”

此参数设置是否使能风速报警信号。

——参数“Wind alarm value [5..50]m/s”

——参数“Wind alarm value [20..150]km/h”

此参数设置风速的报警阈值。当风速超出阈值时，风速警报对象发出警报值。可选项：

5...50/20...150

5.11.2.14.I/O 传感器功能

<ul style="list-style-type: none"> KNX Secure + General Home page + Display view - KNX Channel Channel 1-... Channel 2-... Channel 3-... Channel 4-... Channel 5-... Channel 6-... 	Function	I/O sensor
	Function description (max 18 char.)	
	Function icon	I/O signal
	Icon preview	
	Device online status reference by	Common 2
	Status text for 1-ON	ON
Status text for 0-OFF	OFF	
Period for request external sensor [0...255]	0 min	

图 5.11.2(15) I/O 传感器功能参数设置界面

参数“Status text for 1-ON”

参数“Status text for 0-OFF”

此参数用于自定义状态 on 和 off 的显示描述，比如用于显示 有人/无人、开/关锁、开/关窗、电源开/关等，中文 4 字，英文 12 字符。

参数“Period for request external sensor [0...255]min”

此参数用于设置设备向外部温度传感器发送读请求的时间周期。上电复位和编程完成默认发送读请求，0 时不发送。可选项：**0..255**

5.11.2.15.值发送功能

<ul style="list-style-type: none"> KNX Secure + General Home page + Display view - KNX Channel Channel 1-... Channel 2-... Channel 3-... Channel 4-... Channel 5-... Channel 6-... - KNX Scene 	Function	Value sender
	Function description (max 18 char.)	
	Function icon	General light
	Icon preview	
	Device online status reference by	Always online
	Object type of short operation	1bit value[ON/OFF]
	Reaction on short operation	TOGGLE
	Object type of long operation	None
	Icon display	<input type="radio"/> OFF <input checked="" type="radio"/> ON

图 5.11.2(16) 值发送功能参数设置界面

参数“Object type of short operation”

参数“Object type of long operation”

这两个参数设置按键在短/长操作时，发送的数据类型。可选项：

None

1bit value[ON/OFF]

2bit/4bit value

1byte value[0..255]

2byte value[0..65535]

2byte float value

4byte value[0..4294967295]

4byte float value

——参数“Object datatype”

当选择“2bit/4bit value”时此参数可见。用于设置 2bit 或者 4bit 的数据类型。可选项：

2bit value[0..3]

4bit value[0..15]

参数“Reaction on short operation”

参数“Reaction on long operation”

这两个参数设置执行短/长操作时发送的数据值。值的范围取决于上个参数所选的数据类型。

选择 1bit 时，可选项：

OFF

ON

TOGGLE

选择 2bit/4bit/1byte/2byte/4byte 时，可选项：

Value 1 操作只发送一个值

Alternating Value1/Value2 操作时交替发送值 1/值 2

——参数“Value 1”

选择 2bit/4bit/1byte/2byte/4byte 时，此参数可见。设置执行短/长操作时发送的数据值 1。可选

项根据对象类型显示。可选项：**0~3 / 0~15 / 0~255 / 0~65535 / -670760~670760 / 0~4294967295 / -3.40...~3.40...**

——参数“Value 2”

选择 2bit/4bit/1byte/2byte 且“Alternating Value1/Value2”时，此参数可见。设置执行短/长操作时发送的数据值 2。可选项根据对象类型显示。可选项：**0~3 / 0..15 / 0..255 / 0..65535 / -670760~670760 / 0~4294967295 / -3.40...~3.40...**

参数“Icon display”

此参数设置屏上图标的指示状态。可选项：

OFF

ON

5.12 设置参数界面 “KNX Scene”



图 5.12(1) “KNX Scene”参数功能设置界面



图 5.12(2) "Scene X"参数功能设置界面

参数 "Number of scenes (max.30)"

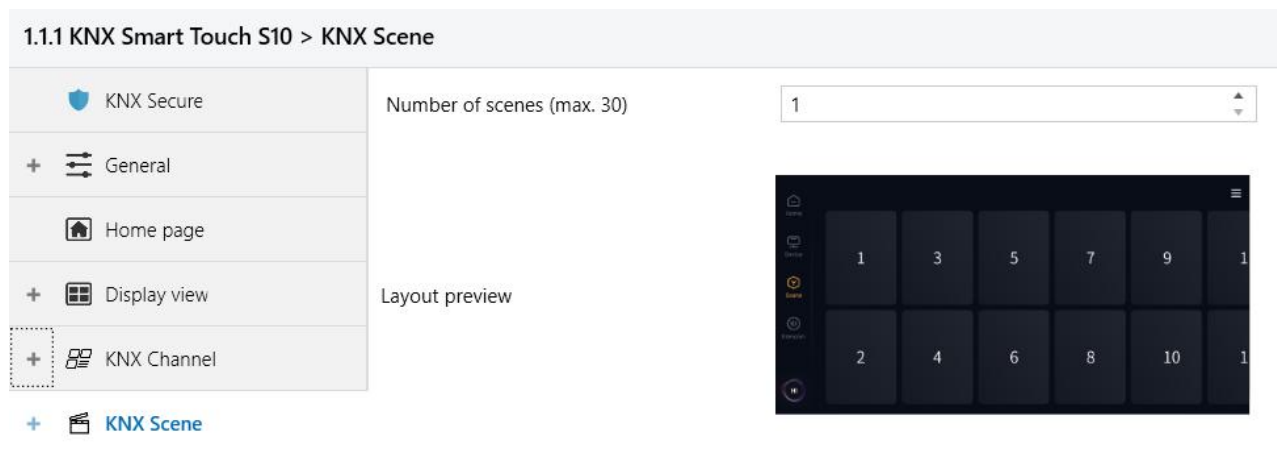
此参数设置场景的数量。可选项：**1...30**

参数 "Function description (max 18char.)"

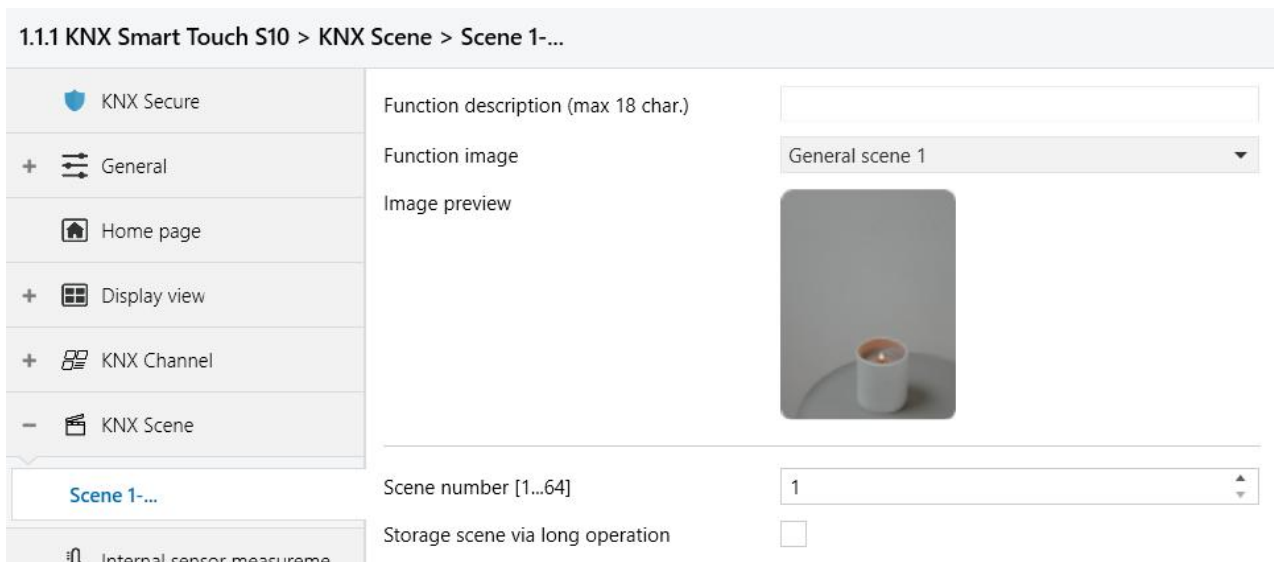
此参数设置场景的功能描述，最多可输入 18 个字符。

参数 "Function image"

此参数设置场景功能的背景图。可选项：

General scene 1

General scene 1

...

Romantic

Play

参数 "Image preview"

此参数显示场景预览图。

参数“Scene number [1..64]”

此参数设置场景号。 可选项：**1...64**

参数“Storage scene via long operation”

此参数设置是否使能长按保存场景。

5.13 设置参数界面 “Internal sensor measurement”



图 5.13 “Internal sensor measurement”参数设置界面

以下几个参数用于设置设备内置温/湿度传感器的校正值、发送条件和错误报告，其它功能如果选用内部

传感器，都参照此处的设置。

Temperature sensor setting 温度传感器设置

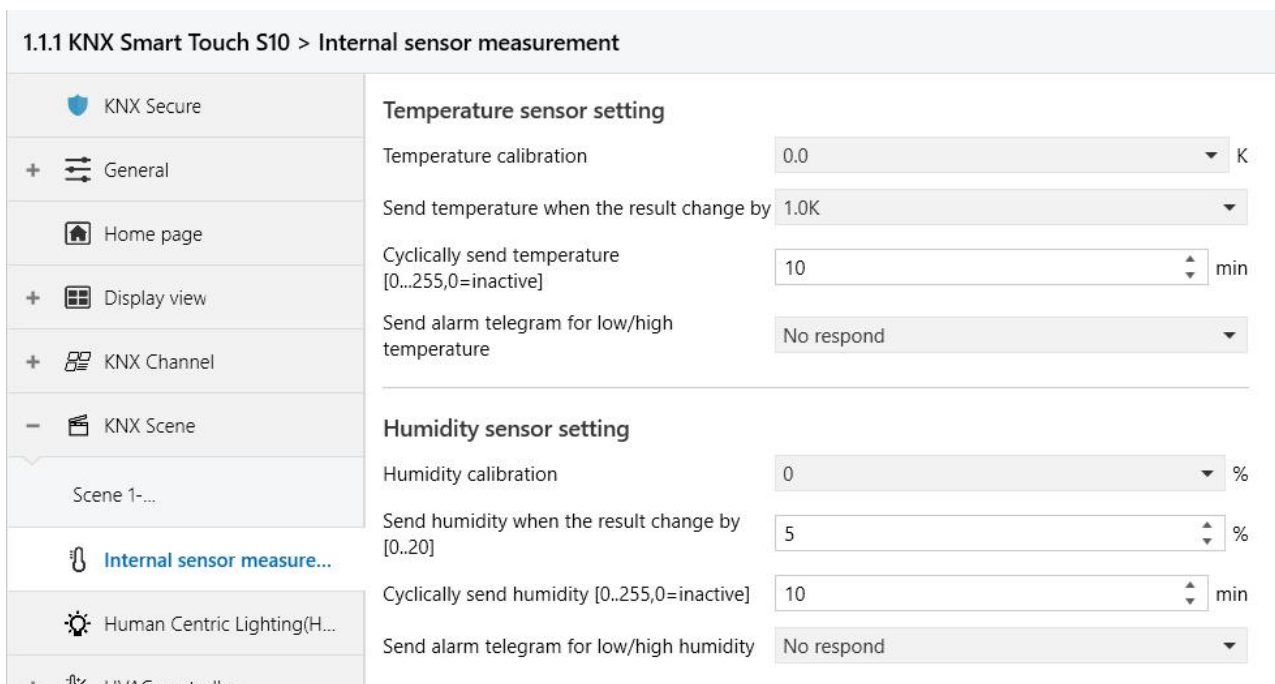
参数“Temperature calibration”

此参数设置内置温度传感器的温度修正值，即对内置温度传感器的测量值进行修正，使其更接近于当前环境温度。可选项：

-5K

...

0K

...

5K

注：内部温度传感器在设备上电后，传感器检测的稳定时间需要 **30 分钟**，因此，设备开始工作前期的温度测量值可能会不准确。

参数“Send temperature when the result change by ”

此参数设置当温度改变一定量时，是否使能发送当前温度测量值到总线上。Disable 时不发送。可选项：

Disable

0.5K

1.0K

...

10K

参数“Cyclically send temperature [0...255,0=inactive]min”

此参数设置温度测量值周期发送到总线上的时间。0 时不发送。可选项：**0..255**

此循环周期是独立的，从编程完成或复位后开始计时，不受改变发送的影响。

参数“Send alarm telegram for low/high temperature”

此参数设置高/低温报警时，设备发送报文的条件。可选项：

No respond

Respond after read only

Respond after change

No respond: 无响应；

Respond after read only: 只有当设备接收到来自于其他总线设备或总线上读取报警状态时，对象“Low temperature alarm”/“High temperature alarm”才把报警状态发送到总线上；

Respond after change: 在报警状态发生改变时，对象“Low temperature alarm”/“High temperature alarm”立即发送报文到总线上报告报警状态。

以下参数选择“Respond after read only”或者“Respond after change”时可见。

——参数“Threshold value for low temperature alarm [0..15]° C”

此参数设置低温报警阈值。当温度低于低阈值时，低温警报对象发出警报。可选项：

0°C

1°C

...

15°C

——参数“Threshold value for high temperature alarm [30..45]° C”

此参数设置高温报警阈值。当温度高于高阈值时，高温警报对象发出警报。可选项：

30°C

31°C

...

45°C

Humidity sensor setting 湿度传感器设置

参数“Humidity calibration”

此参数设置内置湿度传感器的湿度修正值，即对内置湿度传感器的测量值进行修正，使其更接近于当前环境湿度。可选项：**-20% / -15% / -10% / -5% / -3% / -1% / 0% / 1% / 3% / 5% / 10% / 15% / 20%**

参数“Send humidity when the result change by [0..20] %”

此参数设置湿度改变一定量时，发送当前湿度测量值到总线上。0 时不发送。可选项：**0..20**

参数“Cyclically send humidity [0..255,0=inactive]min”

此参数设置湿度测量值周期发送到总线上的时间。0 时不发送。可选项：**0..255**

此循环周期是独立的，从编程完成或复位后开始计时，不受改变发送的影响。

参数“Send alarm telegram for low/high humidity”

此参数设置高/低温报警时，设备发送报文的条件。可选项：

No respond

Respond after read only

Respond after change

No respond: 无响应；

Respond after read only: 只有当设备接收到来自于其他总线设备或总线上读取报警状态时，对象“Low humidity alarm”/“High humidity alarm”才把报警状态发送到总线上；

Respond after change: 在报警状态发生改变时，对象“Low humidity alarm”/“High humidity alarm”立即发送报文到总线上报告报警状态。

以下两个参数选择“Respond after read only”或者“Respond after change”时可见。

——参数“Threshold value for low humidity alarm [5..20]%

此参数设置低湿报警阈值。当湿度低于低阈值时，低湿报警对象发出警报。可选项：**5..20**

——参数“Threshold value for high humidity alarm [70..85]%

此参数设置高湿报警阈值。当湿度高于高阈值时，高湿报警对象发出警报。可选项：**70..85**

第六章 通讯对象说明

通讯对象为设备在总线上与其他设备进行通讯的媒介，只有通讯对象才能进行总线通讯。

注：下文表格属性栏中“C”为通讯对象的通讯功能使能，“W”为通讯对象的值能通过总线改写，“R”为通讯对象的值能通过总线读取，“T”为通讯对象具有传输功能，“U”为通讯对象的值能被更新。

6.1 “General”通用通讯对象

Number *	Name	Object Function	Description	Group Address	Length	C	R	W	T	U	Data Type	Priority
1	General	In operation			1 bit	C	R	-	T	-	switch	Low
2	General	Date			3 bytes	C	-	W	-	-	date	Low
3	General	Time			3 bytes	C	-	W	-	-	time of day	Low
4	General	Screen brightness			1 byte	C	-	W	-	-	percentage (0..100%)	Low

图 6.1 “General”通讯对象

编号	名称	对象功能	类型	属性	DPT
1	General	In operation	1bit	C,R,T	1.001 switch
该通讯对象循环发送报文 1 到总线上，用于指示设备正常运行。					
2/3	General	Date/Time	3byte	C,W,T	11.001 date 10.001 time of day
该通讯对象用于通过总线修改时间和日期。在循环发送激活的情况下，可周期发送当前时间和日期到总线上，便于同步其它设备的时间和日期。 注：当在设备端设置时间为自动更新后，总线修改是无效的。					
4	General	Screen brightness	1byte	C,W	5.001 percentage(0..100%)
该通讯对象用于修改屏幕的背光亮度。亮度输出范围：10~100%，报文值在 10%以下时，直接输出 10%亮度。对象在参数“Screen brightness can be changed via bus”选择使能时可见。					

注：当在设备端设置屏幕背光亮度自动调节后，总线修改是无效的。

表 6.1 “General”通讯对象

6.2 “Internal sensor”通讯对象

Number *	Name	Object Function	Description	Group Address	Length	C	R	W	T	U	Data Type	Priority
5	Internal sensor	Temperature value			2 bytes	C	R	-	T	-	temperature (°C)	Low
6	Internal sensor	Low temperature alarm			1 bit	C	R	-	T	-	alarm	Low
7	Internal sensor	High temperature alarm			1 bit	C	R	-	T	-	alarm	Low
8	Internal sensor	Humidity value			2 bytes	C	R	-	T	-	humidity (%)	Low
9	Internal sensor	Low humidity alarm			1 bit	C	R	-	T	-	alarm	Low
10	Internal sensor	High humidity alarm			1 bit	C	R	-	T	-	alarm	Low

图 6.2 “Internal sensor”通讯对象

编号	名称	对象功能	类型	属性	DPT
5	Internal sensor	Temperature value	2byte	C,R,T	9.001 temperature
该通讯对象用于发送设备的内置温度传感器检测的温度值至总线上。范围：-50~99.8℃					
6	Internal sensor	Low temperature alarm	1bit	C,R,T	1.005 alarm
该通讯对象用于当温度低于低阈值时，阈值由参数定义，低温警报对象发送警报信号到总线上					
7	Internal sensor	High temperature alarm	1bit	C,R,T	1.005 alarm
该通讯对象用于当温度高于高阈值时，阈值由参数定义，高温警报对象发送警报信号到总线上。					
10	Internal sensor	Humidity value	2byte	C,R,T	9.007 humidity
该通讯对象用于发送从总线上湿度传感器发送来的湿度测量值。范围：0~100%					
11	Internal sensor	Low humidity alarm	1bit	C,R,T	1.005 alarm

该通讯对象用于当湿度低于低阈值时，阈值由参数定义，低湿度警报对象发送警报信号到总线上。

12	Internal sensor	High humidity alarm	1bit	C,R,T	1.005 alarm
-----------	------------------------	----------------------------	-------------	--------------	--------------------

该通讯对象用于当湿度低于高阈值时，高湿度警报对象发送警报信号到总线上，阈值由参数定义。

表 6.2 “Internal sensor”通讯对象

6.3 “Logic”通讯对象

6.3.1 “AND/OR/XOR”的通讯对象

Number *	Name	Object Function	Description	Group Address	Length	C	R	W	T	U	Data Type	Priority
11	1st Logic-...	Input a			1 bit	C	-	W	T	U	boolean	Low
12	1st Logic-...	Input b			1 bit	C	-	W	T	U	boolean	Low
13	1st Logic-...	Input c			1 bit	C	-	W	T	U	boolean	Low
14	1st Logic-...	Input d			1 bit	C	-	W	T	U	boolean	Low
15	1st Logic-...	Input e			1 bit	C	-	W	T	U	boolean	Low
16	1st Logic-...	Input f			1 bit	C	-	W	T	U	boolean	Low
17	1st Logic-...	Input g			1 bit	C	-	W	T	U	boolean	Low
18	1st Logic-...	Input h			1 bit	C	-	W	T	U	boolean	Low
19	1st Logic-...	Logic result			1 bit	C	-	-	T	-	boolean	Low

图 6.3.1 “AND/OR/XOR”的通讯对象

编号	名称	对象功能	类型	属性	DPT
11/.../18	1st Logic- {{...}}	Input X	1 bit	C,W,T,U	1.002 boolean
<p>括号中的名称随参数“Description for logic function”描述变化，参数描述为空，则默认显示“1st Logic- {{...}}”。下同。</p> <p>该通讯对象用于接收逻辑输入 Input x 的值。</p>					
19	1st Logic- {{...}}	Logic result	1 bit	C,T	1.002 boolean

该通讯对象用于发送逻辑运算结果。

表 6.3.1 “AND/OR/XOR”的通讯对象

6.3.2 “Gate forwarding”的通讯对象

Number ^	Name	Object Function	Description	Group Address	Length	C	R	W	T	U	Data Type	Priority
11	1st Logic-...	Gate value select			1 byte	C	-	W	-	-	scene number	Low
12	1st Logic-...	Input A			1 bit	C	-	W	-	-	switch	Low
13	1st Logic-...	Input B			1 bit	C	-	W	-	-	switch	Low
14	1st Logic-...	Input C			1 bit	C	-	W	-	-	switch	Low
15	1st Logic-...	Input D			1 bit	C	-	W	-	-	switch	Low
16	1st Logic-...	Output A			1 bit	C	-	-	T	-	switch	Low
17	1st Logic-...	Output B			1 bit	C	-	-	T	-	switch	Low
18	1st Logic-...	Output C			1 bit	C	-	-	T	-	switch	Low
19	1st Logic-...	Output D			1 bit	C	-	-	T	-	switch	Low

图 6.3.2 “Gate forwarding”的通讯对象

编号	名称	对象功能	类型	属性	DTP
11	1st Logic- {...}	Gate value select	1byte	C,W	17.001 scene number
该通讯对象用于选择逻辑门转发的场景。					
12/.../15	1st Logic- {...}	Input X	1bit/4bit/1byte	C,W	1.001 switch 3.007 dimming

						5.010 counter
该通讯对象用于接收逻辑门输入 Input x 的值。						
16/.../19	1st Logic- {{...}}	Output X	1bit/4bit/1byte	C,T		1.001 switch 3.007 dimming 5.010 counter
该通讯对象用于输出逻辑门转发后的值。输出值跟输入值是相同的，但一个输入可转发成一个或多个输出，由参数设置。						

表 6.3.2 “Gate forwarding”的通讯对象

6.3.3 “Threshold comparator”的通讯对象

Number ^	Name	Object Function	Description	Group Address	Length	C	R	W	T	U	Data Type	Priority
11	1st Logic-...	Threshold value input			1 byte	C	-	W	-	U	counter pulses (0..255)	Low
19	1st Logic-...	Logic result			1 bit	C	-	-	T	-	boolean	Low

图 6.3.3 “Threshold comparator”的通讯对象

编号	名称	对象功能	类型	属性	DTP
11	1st Logic- {{...}}	Threshold value input	4bit 1byte 2byte 4byte	C,W,U	3.007 dimming 5.010 counter pulses 7.001 pulses 12.001 counter pulses 8.x signed value 9.x float value

						9.001 temperature 9.007 humidity 9.004 lux
该通讯对象用于输入阈值。						
19	1st Logic- {...}}	Logic result	1bit	C,T		1.002 boolean
该通讯对象用于发送逻辑运算结果。即在对象输入阈值跟参数设定阈值比较后，所应发送的值。						

表 6.3.3 “Threshold comparator”的通讯对象

6.3.4 “Format convert”通讯对象

Number *	Name	Object Function	Description	Group Address	Length	C	R	W	T	U	Data Type	Priority
11	1st Logic-...	Input 1bit-bit0			1 bit	C	-	W	-	U	boolean	Low
12	1st Logic-...	Input 1bit-bit1			1 bit	C	-	W	-	U	boolean	Low
19	1st Logic-...	Output 2bit			2 bit	C	-	-	T	-	switch control	Low

“2x1bit --> 1x2bit”功能:将 2 个 1bit 值转换成一个 2bit 值,如 Input bit1=1, bit0=0--> Output 2bit=2

Number *	Name	Object Function	Description	Group Address	Length	C	R	W	T	U	Data Type	Priority
11	1st Logic-...	Input 1bit-bit0			1 bit	C	-	W	-	U	boolean	Low
12	1st Logic-...	Input 1bit-bit1			1 bit	C	-	W	-	U	boolean	Low
13	1st Logic-...	Input 1bit-bit2			1 bit	C	-	W	-	U	boolean	Low
14	1st Logic-...	Input 1bit-bit3			1 bit	C	-	W	-	U	boolean	Low
15	1st Logic-...	Input 1bit-bit4			1 bit	C	-	W	-	U	boolean	Low
16	1st Logic-...	Input 1bit-bit5			1 bit	C	-	W	-	U	boolean	Low
17	1st Logic-...	Input 1bit-bit6			1 bit	C	-	W	-	U	boolean	Low
18	1st Logic-...	Input 1bit-bit7			1 bit	C	-	W	-	U	boolean	Low
19	1st Logic-...	Output 1byte			1 byte	C	-	-	T	-	counter pulses (0..255)	Low

“8x1bit --> 1x1byte”功能:将 8 个 1bit 值转换成一个 1byte 值,如 Input bit2=1, bit1=1, bit0=1,其它位为 0--> Output 1byte=7

Number ^	Name	Object Function	Description	Group Address	Length	C	R	W	T	U	Data Type	Priority
11	1st Logic-...	Input 1byte			1 byte	C	-	W	-	U	counter pulses (0..255)	Low
19	1st Logic-...	Output 2byte			2 bytes	C	-	-	T	-	pulses	Low

“1x1byte --> 1x2byte”功能：将一个 1byte 值转换成一个 2byte 值，如 Input 1byte=125--> Output 2byte=125,虽然值不变，但值的数据类型已不同

Number ^	Name	Object Function	Description	Group Address	Length	C	R	W	T	U	Data Type	Priority
11	1st Logic-...	Input 1byte-low			1 byte	C	-	W	-	U	counter pulses (0..255)	Low
12	1st Logic-...	Input 1byte-high			1 byte	C	-	W	-	U	counter pulses (0..255)	Low
19	1st Logic-...	Output 2byte			2 bytes	C	-	-	T	-	pulses	Low

“2x1byte --> 1x2byte”功能：将 2 个 1byte 值转换成一个 2byte 值，如 Input 1byte-low = 255 (\$FF), Input 1byte-high = 100 (\$64) --> Output 2byte = 25855 (\$64 FF)

Number ^	Name	Object Function	Description	Group Address	Length	C	R	W	T	U	Data Type	Priority
11	1st Logic-...	Input 2byte-low			2 bytes	C	-	W	-	U	pulses	Low
12	1st Logic-...	Input 2byte-high			2 bytes	C	-	W	-	U	pulses	Low
19	1st Logic-...	Output 4byte			4 bytes	C	-	-	T	-	counter pulses (unsign...Low	Low

“2x2byte --> 1x4byte”功能：将 2 个 2byte 值转换成一个 4byte 值，如 Input 2byte-low = 65530 (\$FF FA), Input 2byte-high = 32768 (\$80 00)--> Output 2byte = 2147549178 (\$80 00 FF FA)

Number ^	Name	Object Function	Description	Group Address	Length	C	R	W	T	U	Data Type	Priority
11	1st Logic-...	Input 1byte			1 byte	C	-	W	-	U	counter pulses (0..255)	Low
12	1st Logic-...	Output 1bit-bit0			1 bit	C	-	-	T	-	boolean	Low
13	1st Logic-...	Output 1bit-bit1			1 bit	C	-	-	T	-	boolean	Low
14	1st Logic-...	Output 1bit-bit2			1 bit	C	-	-	T	-	boolean	Low
15	1st Logic-...	Output 1bit-bit3			1 bit	C	-	-	T	-	boolean	Low
16	1st Logic-...	Output 1bit-bit4			1 bit	C	-	-	T	-	boolean	Low
17	1st Logic-...	Output 1bit-bit5			1 bit	C	-	-	T	-	boolean	Low
18	1st Logic-...	Output 1bit-bit6			1 bit	C	-	-	T	-	boolean	Low
19	1st Logic-...	Output 1bit-bit7			1 bit	C	-	-	T	-	boolean	Low

“1x1byte --> 8x1bit”功能：将 1 个 1byte 值转换成 8 个 1bit 值，如 Input 1byte=200 --> Output bit0=0, bit1=0, bit2=0, bit3=1, bit4=0, bit5=0, bit6=1, bit7=1

Number ^	Name	Object Function	Description	Group Address	Length	C	R	W	T	U	Data Type	Priority
11	1st Logic-...	Input 2byte			2 bytes	C	-	W	-	U	pulses	Low
18	1st Logic-...	Output 1byte-low			1 byte	C	-	-	T	-	counter pulses (0..255)	Low
19	1st Logic-...	Output 1byte-high			1 byte	C	-	-	T	-	counter pulses (0..255)	Low

“1x2byte --> 2x1byte”功能：将 1 个 2byte 值转换成 2 个 1byte 值，如 Input 2byte = 55500 (\$D8 CC) --> Output 1byte-low = 204 (\$CC), Output 1byte-high =216 (\$D8)

Number ^	Name	Object Function	Description	Group Address	Length	C	R	W	T	U	Data Type	Priority
11	1st Logic-...	Input 4byte			4 bytes	C	-	W	-	U	counter pulses (unsign...	Low
18	1st Logic-...	Output 2byte-low			2 bytes	C	-	-	T	-	pulses	Low
19	1st Logic-...	Output 2byte-high			2 bytes	C	-	-	T	-	pulses	Low

“1x4byte --> 2x2byte”功能:将 1 个 4byte 值转换成 2 个 2byte 值,如 Input 4byte = 78009500 (\$04 A6 54 9C) --> Output 2byte-low = 21660 (\$54 9C), Output 2byte-high = 1190 (\$04 A6)

Number ^	Name	Object Function	Description	Group Address	Length	C	R	W	T	U	Data Type	Priority
11	1st Logic-...	Input 3byte			3 bytes	C	-	W	-	U	RGB value 3x(0..255)	Low
17	1st Logic-...	Output 1byte-low			1 byte	C	-	-	T	-	counter pulses (0..255)	Low
18	1st Logic-...	Output 1byte-middle			1 byte	C	-	-	T	-	counter pulses (0..255)	Low
19	1st Logic-...	Output 1byte-high			1 byte	C	-	-	T	-	counter pulses (0..255)	Low

“1x3byte --> 3x1byte”功能:将 1 个 3byte 值转换成 3 个 1byte 值,如 Input 3byte = \$78 64 C8--> Output 1byte-low = 200 (\$C8) , Output 1byte-middle = 100 (\$64) , Output 1byte-high = 120 (\$78)

Number ^	Name	Object Function	Description	Group Address	Length	C	R	W	T	U	Data Type	Priority
11	1st Logic-...	Input 1byte-low			1 byte	C	-	W	-	U	counter pulses (0..255)	Low
12	1st Logic-...	Input 1byte-middle			1 byte	C	-	W	-	U	counter pulses (0..255)	Low
13	1st Logic-...	Input 1byte-high			1 byte	C	-	W	-	U	counter pulses (0..255)	Low
19	1st Logic-...	Output 3byte			3 bytes	C	-	-	T	-	RGB value 3x(0..255)	Low

“3x1byte --> 1x3byte”功能:将 3 个 1byte 值转换成 1 个 3byte 值,如 Input 1byte-low = 150 (\$96), Input 1byte-middle = 100 (\$64), Input 1byte-high = 50 (\$32)--> Output 3byte = \$32 64 96

图 6.3.4 “Format convert”的通讯对象

编号	名称	对象功能	类型	属性	DTP
11	1st Logic- {{...}}	Input ...	1bit 1byte 2byte 3byte 4byte	C,W,U	1.002 boolean 5.010 counter pulses 7.001 pulses 12.001 counter pulses 232.600 RGB value 3x(0..255)

该通讯对象用于输入需要转换的值。						
19	1st {{...}}	Logic-	Output ..	1bit	C,T	1.002 boolean
				2bit		2.001 switch control
				1byte		5.010 counter pulses
				2byte		7.001 pulses
				3byte		12.001 counter pulses
				4byte		232.600 RGB value
						3x(0..255)
该通讯对象用于输出转换后的值。						

表 6.3.4 “Format convert”的通讯对象

6.3.5 “Gate function”通讯对象

Number ^	Name	Object Function	Description	Group Address	Length	C	R	W	T	U	Data Type	Priority
11	1st Logic-...	Input			1 bit	C	-	W	-	-	switch	Low
12	1st Logic-...	Gate input			1 bit	C	-	W	-	-	boolean	Low
19	1st Logic-...	Output			1 bit	C	-	-	T	-	switch	Low

图 6.3.5 “Gate function”的通讯对象

编号	名称	对象功能	类型	属性	DTP
11	1st Logic- {{...}}	Input	1bit	C,W	1.001 switch
			1byte		5.001 percentage

				2byte		5.010 counter pulses 9.001 temperature 7.001 pulses
该通讯对象用于输入需要门过滤的值。						
12	1st Logic- {{...}}	Gate input		1bit	C,W	1.002 boolean
该通讯对象用于控制门输入的开关状态。门开时，输入信号允许通过，则会输出，且如有改变也会发送当前的输入状态；门关时，则不能通过。						
19	1st Logic- {{...}}	Output		1bit 1byte 2byte	C,T	1.001 switch 5.001 percentage 5.010 counter pulses 9.001 temperature 7.001 pulses
该通讯对象用于输出门过滤后的值。只有门输入状态为开时才有输出，按照对象“Gate input”定义。						

表 6.3.5 “Gate function”的通讯对象

6.3.6 “Delay function”通讯对象

Number *	Name	Object Function	Description	Group Address	Length	C	R	W	T	U	Data Type	Priority
11	1st Logic-...	Input			1 bit	C	-	W	-	-	switch	Low
19	1st Logic-...	Output			1 bit	C	-	-	T	-	switch	Low

Input/Output - 1bit[On/Off]

Number ^	Name	Object Function	Description	Group Address	Length	C	R	W	T	U	Data Type	Priority
11	1st Logic-...	Input			1 byte	C	-	W	-	-	percentage (0..100%)	Low
19	1st Logic-...	Output			1 byte	C	-	-	T	-	percentage (0..100%)	Low

Input/Output - 1byte[0..100%]

Number ^	Name	Object Function	Description	Group Address	Length	C	R	W	T	U	Data Type	Priority
11	1st Logic-...	Input			1 byte	C	-	W	-	-	counter pulses (0..255)	Low
19	1st Logic-...	Output			1 byte	C	-	-	T	-	counter pulses (0..255)	Low

Input/Output - 1byte[0..255]

Number ^	Name	Object Function	Description	Group Address	Length	C	R	W	T	U	Data Type	Priority
11	1st Logic-...	Input			2 bytes	C	-	W	-	-	temperature (°C)	Low
19	1st Logic-...	Output			2 bytes	C	-	-	T	-	temperature (°C)	Low

Input/Output - 2byte[Float]

Number ^	Name	Object Function	Description	Group Address	Length	C	R	W	T	U	Data Type	Priority
11	1st Logic-...	Input			2 bytes	C	-	W	-	-	pulses	Low
19	1st Logic-...	Output			2 bytes	C	-	-	T	-	pulses	Low

Input/Output - 2byte[0..65535]

图 6.3.6 “Delay function”通讯对象

编号	名称	对象功能	类型	属性	DTP
11	1st Logic- {...}	Input	1bit 1byte 2byte	C,W	1.001 switch 5.001 percentage 5.010 counter pulses 9.001 temperature 7.001 pulses
该通讯对象用于接收总线上需要延时的值。					
19	1st Logic- {...}	Output	1bit 1byte 2byte	C,T	1.001 switch 5.001 percentage 5.010 counter pulses 9.001 temperature 7.001 pulses
该通讯对象用于发送需要延时转发的值，延时时间按照参数定义。					

表 6.3.6 “Delay function”通讯对象

6.3.7 “Staircase lighting”通讯对象

Number ^	Name	Object Function	Description	Group Address	Length	C	R	W	T	U	Data Type	Priority
11	1st Logic-...	Trigger value			1 bit	C	-	W	-	-	trigger	Low
12	1st Logic-...	Light-on duration time			2 bytes	C	-	W	-	-	time (s)	Low
19	1st Logic-...	Output			1 bit	C	-	-	T	-	switch	Low

图 6.3.7 “Staircase lighting”通讯对象

编号	名称	对象功能	类型	属性	DTP
11	1st Logic- {{...}}	Trigger value	1bit	C,W	1.017 trigger
该通讯对象用于接收总线上触发楼梯灯亮的值。					
12	1st Logic- {{...}}	Light-on duration time	2byte	C,W	7.005 time(s)
该通讯对象用于修改楼梯灯持续时间，修改范围参照参数定义的范围，超出取极限值。					
19	1st Logic- {{...}}	Output	1bit/1byte	C,T	1.001 switch 5.010 counter pulses
该通讯对象用于触发时输出报文值。报文值由参数设置的数据类型决定。					

表 6.3.7 “Staircase lighting”通讯对象

6.4 "Scene Group setting"通讯对象

Number ^	Name	Object Function	Description	Group Address	Length	C	R	W	T	U	Data Type	Priority
83	Scene Group	Main scene trigger			1 byte	C	-	W	-	-	scene number	Low
84	1st Scene Group-Output 1	1 bit value			1 bit	C	-	-	T	-	switch	Low

1 bit value

Number ^	Name	Object Function	Description	Group Address	Length	C	R	W	T	U	Data Type	Priority
83	Scene Group	Main scene trigger			1 byte	C	-	W	-	-	scene number	Low
84	1st Scene Group-Output 1	1byte unsigned value			1 byte	C	-	-	T	-	counter pulses (0..255)	Low

1 byte

Number ^	Name	Object Function	Description	Group Address	Length	C	R	W	T	U	Data Type	Priority
83	Scene Group	Main scene trigger			1 byte	C	-	W	-	-	scene number	Low
84	1st Scene Group-Output 1	HVAC mode			1 byte	C	-	-	T	-	HVAC mode	Low

HVAC mode

Number ^	Name	Object Function	Description	Group Address	Length	C	R	W	T	U	Data Type	Priority
83	Scene Group	Main scene trigger			1 byte	C	-	W	-	-	scene number	Low
84	1st Scene Group-Output 1	2byte unsigned value			2 bytes	C	-	-	T	-	pulses	Low

2byte unsigned value

Number ^	Name	Object Function	Description	Group Address	Length	C	R	W	T	U	Data Type	Priority
83	Scene Group	Main scene trigger			1 byte	C	-	W	-	-	scene number	Low
84	1st Scene Group-Output 1	Temperature			2 bytes	C	-	-	T	-	temperature (°C)	Low

Temperature

Number ^	Name	Object Function	Description	Group Address	Length	C	R	W	T	U	Data Type	Priority
83	Scene Group	Main scene trigger			1 byte	C	-	W	-	-	scene number	Low
84	1st Scene Group-Output 1	RGB value			3 bytes	C	-	-	T	-	RGB value 3x(0..255)	Low

RGB value

Number ^	Name	Object Function	Description	Group Address	Length	C	R	W	T	U	Data Type	Priority
83	Scene Group	Main scene trigger			1 byte	C	-	W	-	-	scene number	Low
84	1st Scene Group-Output 1	RGBW value			6 bytes	C	-	-	T	-	RGBW value 4x(0..100%)	Low

RGBW value

图 6.4 "Scene Group setting"通讯对象

编号	名称	对象功能	类型	属性	DPT
83	Scene Group	Main scene trigger	1byte	C, W	17.001 scene number
该通讯对象通过调用场景号的方式来触发事件组中的每个输出发送特定的值到总线上。报文：0..63					
84	1st Scene Group-{{Output X}}	1bit value 1byte unsigned value HVAC mode 2byte unsigned value Temperature RGB value RGBW value	1bit 1byte e 2byte e 3byte e 6byte e	C,T	1.001 switch 5.010 counter pulses 20.102 HVAC mode 7.001 pulses 9.001 temperature 232.600 RGB value 3x(0..255) 251.600 DPT_Colour_RGBW
<p>当某个场景被调用时，此通讯对象用于发送此场景的对应输出值到总线上。如果该输出未设置此场景，则不会发送。</p> <p>共可设置 8 个事件组，每组 8 个输出。</p>					

表 6.4 “Scene Group setting”通讯对象

6.5 “HVAC controller”通讯对象

6.5.1 “Room temperature controller (RTC)”通讯对象

Number *	Name	Object Function	Description	Group Address	Length	C	R	W	T	U	Data Type	Priority
148	Controller 1 - ...	Power on/off			1 bit	C	R	W	-	-	switch	Low
149	Controller 1 - ...	External temperature sensor			2 bytes	C	-	W	T	U	temperature (°C)	Low
150	Controller 1 - ...	Base setpoint adjustment			2 bytes	C	-	W	-	-	temperature (°C)	Low
151	Controller 1 - ...	Setpoint offset			1 bit	C	-	W	-	-	step	Low
152	Controller 1 - ...	Float offset value			2 bytes	C	-	W	-	-	temperature differenc...	Low
153	Controller 1 - ...	Setpoint offset reset			1 bit	C	-	W	-	-	reset	Low
154	Controller 1 - ...	Heating/Cooling mode			1 bit	C	-	W	-	-	cooling/heating	Low
155	Controller 1 - ...	Operation mode			1 byte	C	-	W	-	-	HVAC mode	Low
156	Controller 1 - ...	Comfort mode			1 bit	C	-	W	-	-	enable	Low
157	Controller 1 - ...	Economy mode			1 bit	C	-	W	-	-	enable	Low
158	Controller 1 - ...	Frost/Heat protection mode			1 bit	C	-	W	-	-	enable	Low
159	Controller 1 - ...	Standby mode			1 bit	C	-	W	-	-	enable	Low
160	Controller 1 - ...	Extended comfort mode			1 bit	C	-	W	-	-	acknowledge	Low
161	Controller 1 - ...	Fan automatic operation			1 bit	C	-	W	-	-	enable	Low
162	Controller 1 - ...	Window contact			1 bit	C	-	W	T	U	window/door	Low
163	Controller 1 - ...	Presence detector			1 bit	C	-	W	T	U	occupancy	Low
164	Controller 1 - ...	Actual temperature, status			2 bytes	C	R	-	T	-	temperature (°C)	Low
165	Controller 1 - ...	Base temperature setpoint, status			2 bytes	C	R	-	T	-	temperature (°C)	Low
166	Controller 1 - ...	Setpoint offset, status			2 bytes	C	R	-	T	-	temperature differenc...	Low
167	Controller 1 - ...	Current temperature setpoint, status			2 bytes	C	R	-	T	-	temperature (°C)	Low
168	Controller 1 - ...	Heating/Cooling mode, status			1 bit	C	R	-	T	-	cooling/heating	Low
169	Controller 1 - ...	Operation mode, status			1 byte	C	R	-	T	-	HVAC mode	Low
170	Controller 1 - ...	Comfort mode, status			1 bit	C	R	-	T	-	enable	Low
171	Controller 1 - ...	Economy mode, status			1 bit	C	R	-	T	-	enable	Low
172	Controller 1 - ...	Frost/Heat protection mode, status			1 bit	C	R	-	T	-	enable	Low
173	Controller 1 - ...	Standby mode, status			1 bit	C	R	-	T	-	enable	Low
174	Controller 1 - ...	Heating control value			1 byte	C	R	-	T	-	percentage (0..100%)	Low
175	Controller 1 - ...	Cooling control value			1 byte	C	R	-	T	-	percentage (0..100%)	Low
176	Controller 1 - ...	Fan speed			1 byte	C	-	-	T	-	percentage (0..100%)	Low
177	Controller 1 - ...	Fan speed low			1 bit	C	-	-	T	-	switch	Low
178	Controller 1 - ...	Fan speed medium			1 bit	C	-	-	T	-	switch	Low
179	Controller 1 - ...	Fan speed high			1 bit	C	-	-	T	-	switch	Low
180	Controller 1 - ...	Fan speed off			1 bit	C	-	-	T	-	switch	Low
181	Controller 1 - ...	Additional Heating control value			1 bit	C	R	-	T	-	switch	低
181	Controller 1 - ...	Additional Heating/Cooling control value			1 bit	C	R	-	T	-	switch	低
182	Controller 1 - ...	Additional Cooling control value			1 bit	C	R	-	T	-	switch	低

图 6.5.1 “Room temperature controller(RTC)”通讯对象

编号	名称	对象功能	类型	属性	DPT
148	Controller X-{{...}}	Power on/off	1bit	C,W,R	1.001 switch
<p>此通讯对象用于接收总线上控制温控器开关的报文。报文值：</p> <p style="text-align: center;">1——开</p> <p style="text-align: center;">0——关</p> <p>括号中的名称随参数“Description (max 30char.)”描述变化，参数描述为空，则默认显示“Controller X - ...”。下同。</p>					
149	Controller X-{{...}}	External temperature sensor	2byte	C,W,T ,U	9.001 temperature
<p>该通讯对象用于接收从总线上温度传感器发送来的温度测量值。范围：-50~99.8°C</p>					
150	Controller X-{{...}}	Current setpoint adjustment Base setpoint adjustment	2byte	C,W	9.001 temperature
<p>在操作模式不使能和绝对调整下“Current setpoint adjustment”可见。不使能时，用于修改设定温度的基准值；绝对调整时，用于修改当前房间操作模式的温度设定值。</p> <p>仅在相对调整的情况下“Base setpoint adjustment”可见，用于修改设定温度的基准值，即舒适模式的温度设定值，待机和节能模式的设定温度根据相对变化量改变。任何情况下，保护模式的温度设定值不能被总线修改。</p>					
151	Controller X-{{...}}	Setpoint offset	1bit	C,W	1.007 step

仅在相对调整，且偏移功能使能时该通讯对象可见。通过调整偏移量来间接调整设定温度，步进值根据参数设置。报文值：

1——正向增加偏移量

0——负向减少偏移量

152	Controller X-{{...}}	Float offset value	2byte	C,W	9.002 temperature difference
------------	---------------------------------------	---------------------------	--------------	------------	---------------------------------------------------------

仅在相对调整,且偏移功能使能时可见。通过 2byte 的浮点值修改累计偏移量

153	Controller X-{{...}}	Setpoint offset reset	1bit	C,W	1.015 reset
------------	---------------------------------------	------------------------------	-------------	------------	--------------------

仅在相对调整，且偏移功能使能时该通讯对象可见。当报文值为 1 时，重置偏移量。

154	Controller X-{{...}}	Heating/Cooling mode	1bit	C,W	1.100 cooling/heating
------------	---------------------------------------	-----------------------------	-------------	------------	----------------------------------------

该通讯对象用于通过总线切换加热和制冷。报文值：

1——加热

0——制冷

155	Controller X-{{...}}	Operation mode	1byte	C,W	20.102 HVAC mode
------------	---------------------------------------	-----------------------	--------------	------------	------------------------------------------

156	Controller X-{{...}}	Comfort mode	1bit	C,W	1.003 enable
------------	---------------------------------------	---------------------	-------------	------------	---------------------

157	Controller X-{{...}}	Economy mode	1bit	C,W	1.003 enable
------------	---------------------------------------	---------------------	-------------	------------	---------------------

158	Controller	Frost/Heat protection	1bit	C,W	1.003 enable
------------	-------------------	------------------------------	-------------	------------	---------------------

	X-{{...}}	mode			
159	Controller X-{{...}}	Standby mode	1bit	C,W	1.003 enable
<p>这些通讯对象在操作模式使能且 1bit 模式参数使能时可见，用于通过总线控制温控器的操作模式。</p> <p>对象 156——舒适模式</p> <p>对象 157——节能模式</p> <p>对象 158——保护模式</p> <p>对象 159——待机模式</p> <p>接收到报文“1”时，激活相应模式。1bit 待机对象不使能，舒适、节能和保护模式的报文都为 0 时，为待机模式。1bit 待机对象使能，待机对象接收“1”为待机，0 不处理。</p>					
160	Controller X-{{...}}	Extended comfort mode	1bit	C,W	1.016 acknowledge
<p>该通讯对象用于触发延长舒适模式的时间。报文值：</p> <p>1——激活舒适模式</p> <p>0——无意义</p> <p>当对象接收到报文 1 时，舒适模式激活，在延时期间，如果再次收到报文 1，时间重新计时，一旦时间计时完成，舒适模式返回到之前的操作模式。如果在延时期间，有新的操作模式，则会退出此舒适模式。开关操作时会退出计时，加热/制冷切换则不会。</p>					
161	Controller X-{{...}}	Fan automatic operation	1bit	C,W	1.003 enable
<p>该对象用于通过总线激活风速的自动控制。报文值：</p> <p>1——激活自动</p> <p>0——退出自动</p>					

162	Controller X-{{...}}	Window contact	1bit	C,W,T ,U	1.019 Window/door
<p>该通讯对象用于接收窗户触点的开关状态。报文值：</p> <p>1——窗户打开</p> <p>0——窗户关闭</p>					
163	Controller X-{{...}}	Presence detector	1bit	C,W,T ,U	1.018 occupancy
<p>该通讯对象用于接收存在传感器检测的房间占有状态。报文值：</p> <p>1——有人</p> <p>0——无人</p>					
164	Controller X-{{...}}	Actual temperature, status	2byte	C,R,T	9.001 temperature
<p>当温控功能的温度参照来源为内部和外部传感器组合时，该通讯对象可见。用于发送组合后的实际温度到总线上。</p>					
165	Controller X-{{...}}	Base temperature setpoint, status	2byte	C,R,T	9.001 temperature
<p>仅在相对调整的情况下该通讯对象可见。用于发送当前基准温度设定值到总线上。</p>					
166	Controller X-{{...}}	Setpoint offset, status	2byte	C,R,T	9.002 temperature difference
<p>仅在相对调整，且偏移功能使能时该通讯对象可见。用于发送基准设定温度的累计偏移量到总线上。</p>					
167	Controller X-{{...}}	Current temperature setpoint, status	2byte	C,R,T	9.001 temperature

该通讯对象用于发送当前的温度设定值到总线上。

168	Controller X-{{...}}	Heating/Cooling mode, status	1bit	C,R,T	1.100 cooling/heating
------------	---------------------------------------	-----------------------------------------------	-------------	--------------	----------------------------------------

该通讯对象用于反馈切换制冷和制热功能的报文到总线上。

169	Controller X-{{...}}	Operation mode, status	1byte	C,R,T	20.102 HVAC mode
170	Controller X-{{...}}	Comfort mode, status	1bit	C,R,T	1.003 enable
171	Controller X-{{...}}	Economy mode, status	1bit	C,R,T	1.003 enable
172	Controller X-{{...}}	Frost/Heat protection mode, status	1bit	C,R,T	1.003 enable
173	Controller X-{{...}}	Standby mode, status	1bit	C,R,T	1.003 enable

这些通讯对象在操作模式使能且 1bit 模式参数使能时可见，用于发送温控器的操作模式状态到总线上。

对象 170——舒适模式

对象 171——节能模式

对象 172——保护模式

对象 173——待机模式

当激活某一模式时，仅相应的对象发送报文“1”。1bit 待机对象不使能时，激活待机模式，舒适、节能和保护三个对象一起发送 0。1bit 待机对象使能时，激活待机模式时，仅待机对象发送 1。

注意：通过总线切换时，不需要发送模式状态到总线上，风速等操作也如此。

174	Controller X-{{...}}	Heating control value Heating/Cooling control value	1bit/ 1byte	C,R,T	1.001 switch/5.001 percentage
175	Controller X-{{...}}	Cooling control value	1bit/ 1byte	C,R,T	1.001 switch/5.001 percentage

该通讯对象发送制热或制冷功能的控制值到总线上。对象的数据类型由参数设定。

176	Controller X-{{...}}	Fan speed	1byte	C,T	5.001 percentage 5.100 fan stage
177	Controller X-{{...}}	Fan speed low	1bit	C,T	1.001 switch
178	Controller X-{{...}}	Fan speed medium	1bit	C,T	1.001 switch
179	Controller X-{{...}}	Fan speed high	1bit	C,T	1.001 switch
180	Controller X-{{...}}	Fan speed off	1bit	C,T	1.001 switch

这些通讯对象用于发送自动控制下的风速报文到总线上。

1bit 对象根据参数设置显示：

对象 177——低风速

对象 178——中风速

对象 179——高风速

对象 180——关风速

切换到某个风速时，仅相应对象发送报文“1”。当 1bit-off 对象未使能时，切换到关风速时，所有对

象发送报文“0”（此情况适合与 GVS 的风机执行器对接）；

当 1bit-off 对象使能时，切换到关风速时，仅关风速对象发送报文“1”（适合与其它厂家的风机执行器对接）。

181	Controller X-{{...}}	Additional control value Additional heating/cooling control value	heating	1bit/ 1byte	C,R,T	1.001 switch/5.001 percentage
182	Controller X-{{...}}	Additional control value	cooling	1bit/ 1byte	C,R,T	1.001 switch/5.001 percentage

这些通讯对象用于发送额外控制阀门的控制值。

1bit: 开启阀门发报文 1, 关闭阀门发报文 0

1byte: 开启阀门发报文 100%, 关闭阀门发报文 0%

表 6.5.1 “Room temperature controller(RTC)”通讯对象

6.5.2 “Ventilation controller”通讯对象

Number *	Name	Object Function	Description	Group Address	Length	C	R	W	T	U	Data Type	Priority
148	Controller 1 - ...	Fan automatic operation			1 bit	C	R	W	-	-	enable	Low
149	Controller 1 - ...	PM 2.5 value			2 bytes	C	-	W	T	U	pulses	Low
176	Controller 1 - ...	Fan speed			1 byte	C	-	-	T	-	percentage (0..100%)	Low

图 6.5.2 “Ventilation controller”通讯对象

编号	名称	对象功能	类型	属性	DPT
148	Controller X-{{...}}	Fan automatic operation	1bit	C,R,W	1.003 enable
<p>该对象用于通过总线激活风速的自动控制。报文值：</p> <p>1——激活自动</p> <p>0——退出自动</p>					
149	Controller X-{{...}}	PM 2.5 value VOC value CO2 value	2byte	C,W,T ,U	7.001 pulse 9.030 concentration(ug/m3) 9.008 parts/million(ppm)
<p>该通讯对象用于接收 PM2.5/VOC/CO2 的输入值，对象的数据类型由参数设定。单位为 ug/m³ 或 ppm。范围：0~999ug/m³ 或 0~4000ppm</p>					
176	Controller X-{{...}}	Fan speed	1byte	C,T	5.001 percentage 5.100 fan stage

该通讯对象用于发送自动控制下的风速报文到总线上。每档风速对应的报文值由参数设置的数据类型决定。

表 6.5.2 “Ventilation controller”通讯对象

6.6 “Human Centric Lighting(HCL)”通讯对象

Number *	Name	Object Function	Description	Group Address	Length	C	R	W	T	U	Data Type	Priority
358	Human Centric Lighting(...	Start HCL			1 bit	C	-	W	-	-	start/stop	Low
359	Human Centric Lighting(...	HCL status			1 bit	C	R	-	T	-	state	Low
360	Human Centric Lighting(...	Brightness value			1 byte	C	-	-	T	-	percentage (0..100%)	Low
361	Human Centric Lighting(...	Colour temperature value			2 bytes	C	-	-	T	-	absolute colour tempe...	Low
364	Human Centric Lighting(...	Switch control			1 bit	C	-	W	-	-	switch	Low
365	Human Centric Lighting(...	Brightness control value			1 byte	C	-	W	-	-	percentage (0..100%)	Low
366	Human Centric Lighting(...	Colour temperature control value			2 bytes	C	-	W	-	-	absolute colour tempe...	Low

Normal

362	Human Centric Lighting(HCL)	Warm white brightness			1 byte	C	-	-	T	-	percentage (0..100%)	低
363	Human Centric Lighting(HCL)	Cool white brightness			1 byte	C	-	-	T	-	percentage (0..100%)	低
364	Human Centric Lighting(HCL)	Switch control			1 bit	C	-	W	-	-	switch	低
367	Human Centric Lighting(HCL)	Warm white brightness control value			1 byte	C	-	W	-	-	percentage (0..100%)	低
368	Human Centric Lighting(HCL)	Cool white brightness control value			1 byte	C	-	W	-	-	percentage (0..100%)	低

Directly(with warm/cool white algorithm)

图 6.6 “Human Centric Lighting(HCL)”通讯对象

编号	名称	对象功能	类型	属性	DPT
358	Human Centric Lighting(HCL)	Start HCL	1bit	C,W	1.010 start/stop
<p>该通讯对象用于启动人本照明（HCL）设置。报文值：</p> <p>1——启动</p> <p>0——停止</p>					
359	Human	HCL status	1bit	C,R,T	1.011 state

9	Centric Lighting(HCL)				
该通讯对象用于发送 HCL 的状态报文到总线上。					
360	Human Centric Lighting(HCL)	Brightness value	1byte	C,T	5.001 percentage(0..100%)
365	Human Centric Lighting(HCL)	Brightness control value	1byte	C,W	5.001 percentage(0..100%)
<p>通过 HCL 控制亮度时，这两个通讯对象显示。报文值：0...100%</p> <p>Obj.360：用于发送调光报文到总线上，即发送亮度值。</p> <p>Obj.365：用于接收总线上控制亮度的报文。</p>					
361	Human Centric Lighting(HCL)	Colour temperature value	2byte	C,T	7.600 absolute colour temperature
366	Human Centric Lighting(HCL)	Colour temperature control value	2byte	C,W	7.600 absolute colour temperature
这两个通讯对象适用于普通控制的色温控制类型。报文值：2000...7000 K					

Obj.361: 用于通过 HCL 发送色温控制报文到总线上。

Obj.366: 用于接收总线上控制色温的报文。

36 2	Human Centric Lighting(HCL)	Warm brightness	white	1byte	C,T	5.001 percentage(0..100%)
36 7	Human Centric Lighting(HCL)	Warm brightness value	white control	1byte	C,W	5.001 percentage(0..100%)

这两个通讯对象适用于直接控制下双色灯的暖白亮度控制。报文值: 0...100%

Obj.362: 用于发送暖白调光报文到总线上, 即发送暖白亮度值。

Obj.367: 用于接收总线上控制灯光暖白亮度的报文。

36 3	Human Centric Lighting(HCL)	Cool white brightness		1byte	C,T	5.001 percentage(0..100%)
36 8	Human Centric Lighting(HCL)	Cool white brightness control value		1byte	C,W	5.001 percentage(0..100%)

这两个通讯对象适用于直接控制下双色灯的冷白亮度控制。报文值: 0...100%

Obj.363: 用于发送冷白调光报文到总线上, 即发送冷白亮度值。

Obj.368: 用于接收总线上控制灯光冷白亮度的报文。

36	Human	Switch control	1bit	C,W	1.001 switch
4	Centric Lighting(HCL)				

在 HCL 运行中，当接收到总线开关控制报文 OFF 时选择停止 HCL 运行，则该通讯对象用于接收开关控制报文。即报文 0 停止，1 无意义。

表 6.6 “Human Centric Lighting(HCL)”通讯对象

6.7 “Schedule function”通讯对象

Number *	Name	Object Function	Description	Group Address	Length	C	R	W	T	U	Data Type	Priority
369	Schedule 1-...	On/Off			1 bit	C	-	-	T	-	switch	Low
370	Schedule 1-...	Disable/Enable			1 bit	C	-	W	-	-	enable	Low
369	Schedule 1-...	1byte unsigned value			1 byte	C	-	-	T	-	counter pulses (0..255)	Low
369	Schedule 1-...	HVAC mode			1 byte	C	-	-	T	-	HVAC mode	Low
369	Schedule 1-...	Scene control			1 byte	C	-	-	T	-	scene number	Low
369	Schedule 1-...	2byte unsigned value			2 bytes	C	-	-	T	-	pulses	Low
369	Schedule 1-...	Temperature value			2 bytes	C	-	-	T	-	temperature (°C)	Low

图 6.7 “Schedule function”通讯对象

编号	名称	对象功能	类型	属性	DPT
369	Schedule X-{{...}}	On/Off	1bit	C,T	1.001 switch
		1byte unsigned value	1byte		5.010 counter pulses(0..255)
		HVAC mode	1byte		20.102 HVAC mode
		Scene control	2byte		17.001 scene number
		2byte unsigned value	2byte		7.001 pulses
		Temperature value			9.001 temperature
		<p>该通讯对象用于发送定时功能的预设报文值到总线，定时时间、预设值和对象类型由参数设置。时间到了将发送预设的报文值到总线上。总共可设置 16 个定时。</p>			
370	Schedule	Disable/Enable	1bit	C,W	1.003 enable

	X-{{...}}			
<p>该通讯对象用于禁止/使能定时功能。禁止/使能的报文值具体由参数进行定义。禁止后，该定时将不启用。</p>				

表 6.7 “Schedule function”通讯对象

6.8 “Alarm function”通讯对象

Number ^	Name	Object Function	Description	Group Address	Length	C	R	W	T	U	Data Type	Priority
401	Alarm 1-...	Alarm acknowledge			1 bit	C	-	-	T	-	acknowledge	Low
402	Alarm 1-...	Alarm message			14 bytes	C	-	W	-	-	Character String (ISO 8...	Low
403	Alarm 1-...	Alarm input			1 bit	C	-	W	T	U	alarm	Low

图 6.8 “Alarm function”通讯对象

编号	名称	对象功能	类型	属性	DPT
401	Alarm X-{{...}}	Alarm acknowledge	1bit	C,T	1.016 acknowledge
<p>该通讯对象用于当用户点击屏上确认警报信息后，发送应答报文 1 到总线上。</p>					
402	Alarm X-{{...}}	Alarm message	14byte e	C,W	16.001 character string (ISO 8859-1)
<p>该通讯对象用于通过对象输入屏上显示的警报信息。初始未收到值时，弹窗显示为空。</p>					
403	Alarm X-{{...}}	Alarm input	1bit	C,W,T, U	1.005 alarm
<p>该通讯对象用于接收总线上的警报信号。报文值：</p> <p style="text-align: center;">0 —— 解除警报</p> <p style="text-align: center;">1 —— 警报</p>					

表 6.8 “Alarm function”通讯对象

10.1 “KNX Channel general”通讯对象

Number *	Name	Object Function	Description	Group Address	Length	C	R	W	T	U	Data Type	Priority
473	KNX Channel general	Device online common 1, status			1 bit	C	-	W	T	U	switch	Low

图 10.1 “KNX Channel general”通讯对象

编号	名称	对象功能	类型	属性	DPT
473...482	KNX Channel general	Device online common X, status	1bit	C,W,T,U	1.* 1-bit

Time period request for common x 的时间>0 时显示。

该对象用于周期发送通用设备在线状态的读请求报文，以便查询各个通用设备的当前在线状态。

表 10.1 “KNX Channel general”通讯对象

6.10 “KNX Channel X”通讯对象

1~120 每个通道 21 个对象，共 120*21=2520 个对象，支持开关、调光，色温、窗帘、空调、新风、地暖、背景音乐等。

121~240 每个通道 16 个对象，共 120*16=1920 个对象，只能配置简单的开关、调光、色温、窗帘和值发送功能

Number *	Name	Object Function	Description	Group Address	Length	C	R	W	T	U	Data Type	Priority
483	KNX Channel 1-...	Device online, status			1 bit	C	-	W	T	U	switch	Low
484	KNX Channel 1-...	Locking object			1 bit	C	-	W	-	-	enable	Low

图 6.10 “KNX Channel X”通讯对象

编号	名称	对象功能	类型	属性	DPT
483	KNX Channel X-{{...}}	Device online, status	1bit	C,W,T,U	1.001 switch
<p>在线请求的设备类型为独立设备时可见。</p> <p>该对象用于周期发送设备在线状态的读请求报文，以便查询此设备的当前在线状态并更新显示。</p>					
484	KNX Channel X-{{...}}	Locking object	1bit	C,W	1.003 enable
<p>适用于以下所有功能，除传感器、能源监测设备外。</p> <p>该对象用于锁定/解锁图标功能，1-解锁，0-锁定。</p>					

表 6.10 “KNX Channel X”通讯对象

6.10.1 “Switch”通讯对象

485	KNX Channel 1-...	Switch	1 bit	C - - T -	switch	低
490	KNX Channel 1-...	Switch, status	1 bit	C - W T U	switch	低

Switch

485	KNX Channel 1-...	Switch	1 bit	C - - T -	switch	低
-----	-------------------	--------	-------	-----------	--------	---

Press/Release switch

图 6.10.1 “Switch”通讯对象

编号	名称	对象功能	类型	属性	DPT
485	KNX Channel X-{{...}}	Switch	1bit	C,T	1.001 switch
<p>该通讯对象用于发送开/关报文到总线上，适用于开关、按下/松开开关、亮度/相对调光、亮度+色温调节。</p> <p>报文值：</p> <p>1 —— 开灯</p> <p>0 —— 关灯</p>					
490	KNX Channel X-{{...}}	Switch, status	1bit	C,W,T,U	1.001 switch 3.007 dimming

该通讯对象用于接收其它总线设备回应的开/关状态，并反馈到屏上显示，适用于开关、亮度/相对调光、亮度+色温调节、开关指示器。

表 6.10.1 “Switch”通讯对象

6.10.2 “Dimming”通讯对象

485	KNX Channel 1-...	Switch	1 bit	C	-	-	T	-	switch	低
486	KNX Channel 1-...	Relative dimming	4 bit	C	-	W	T	-	dimming control	低
490	KNX Channel 1-...	Switch, status	1 bit	C	-	W	T	U	switch	低

Relative dimming

485	KNX Channel 1-...	Switch	1 bit	C	-	-	T	-	switch	低
487	KNX Channel 1-...	Brightness dimming	1 byte	C	-	-	T	-	percentage (0..100%)	低
490	KNX Channel 1-...	Switch, status	1 bit	C	-	W	T	U	switch	低
491	KNX Channel 1-...	Brightness, status	1 byte	C	-	W	T	U	percentage (0..100%)	低

Brightness dimming

485	KNX Channel 1-...	Switch	1 bit	C	-	-	T	-	switch	低
486	KNX Channel 1-...	Relative dimming	4 bit	C	-	-	T	-	dimming control	低
487	KNX Channel 1-...	Brightness dimming	1 byte	C	-	-	T	-	percentage (0..100%)	低
490	KNX Channel 1-...	Switch, status	1 bit	C	-	W	T	U	switch	低
491	KNX Channel 1-...	Brightness, status	1 byte	C	-	W	T	U	percentage (0..100%)	低

Relative&Brightness dimming

图 6.10.2 “Dimming”通讯对象

编号	名称	对象功能	类型	属性	DPT
486	KNX Channel X-{{...}}	Relative dimming	4bit	C,W,T	3.007 dimming control
该通讯对象适用于相对调光。用于发送相对调光的报文到总线上，上调/下调/停止调光。					
487	KNX Channel X-{{...}}	Brightness dimming	1byte	C,T	5.001 percentage(0..100%)
491	KNX Channel X-{{...}}	Brightness, status	1byte	C,W,T,U	5.001 percentage(0..100%)

这两个通讯对象适用于亮度调光。报文值：0..100%

Obj.487：用于发送调光报文到总线上，即发送亮度值。

Obj.491：用于接收调光器回应的灯光亮度状态。

表 6.10.2 “Dimming”通讯对象

6.10.3 “Colour and colour temperature control”通讯对象

Number ^	Name	Object Function	Description	Group Address	Length	C	R	W	T	U	Data Type	Priority
483	KNX Channel 1-...	Device online, status			1 bit	C	-	W	T	U	switch	Low
484	KNX Channel 1-...	Locking object			1 bit	C	-	W	-	-	enable	Low
485	KNX Channel 1-...	Switch			1 bit	C	-	-	T	-	switch	Low
486	KNX Channel 1-...	Red dimming value			1 byte	C	-	-	T	-	percentage (0..100%)	Low
487	KNX Channel 1-...	Green dimming value			1 byte	C	-	-	T	-	percentage (0..100%)	Low
488	KNX Channel 1-...	Blue dimming value			1 byte	C	-	-	T	-	percentage (0..100%)	Low
490	KNX Channel 1-...	Switch, status			1 bit	C	-	W	T	U	switch	Low
491	KNX Channel 1-...	Red brightness, status			1 byte	C	-	W	T	U	percentage (0..100%)	Low
492	KNX Channel 1-...	Green brightness, status			1 byte	C	-	W	T	U	percentage (0..100%)	Low
493	KNX Channel 1-...	Blue brightness, status			1 byte	C	-	W	T	U	percentage (0..100%)	Low

RGB_3x1byte

Number ^	Name	Object Function	Description	Group Address	Length	C	R	W	T	U	Data Type	Priority
483	KNX Channel 1-...	Device online, status			1 bit	C	-	W	T	U	switch	Low
484	KNX Channel 1-...	Locking object			1 bit	C	-	W	-	-	enable	Low
485	KNX Channel 1-...	Switch			1 bit	C	-	-	T	-	switch	Low
486	KNX Channel 1-...	RGB dimming value			3 bytes	C	-	-	T	-	RGB value 3x(0..255)	Low
490	KNX Channel 1-...	Switch, status			1 bit	C	-	W	T	U	switch	Low
491	KNX Channel 1-...	RGB brightness, status			3 bytes	C	-	W	T	U	RGB value 3x(0..255)	Low

RGB_1x3byte

Number ^	Name	Object Function	Description	Group Address	Length	C	R	W	T	U	Data Type	Priority
483	KNX Channel 1-...	Device online, status			1 bit	C	-	W	T	U	switch	Low
484	KNX Channel 1-...	Locking object			1 bit	C	-	W	-	-	enable	Low
485	KNX Channel 1-...	Switch			1 bit	C	-	-	T	-	switch	Low
486	KNX Channel 1-...	Red dimming value			1 byte	C	-	-	T	-	percentage (0..100%)	Low
487	KNX Channel 1-...	Green dimming value			1 byte	C	-	-	T	-	percentage (0..100%)	Low
488	KNX Channel 1-...	Blue dimming value			1 byte	C	-	-	T	-	percentage (0..100%)	Low
489	KNX Channel 1-...	White dimming value			1 byte	C	-	-	T	-	percentage (0..100%)	Low
490	KNX Channel 1-...	Switch, status			1 bit	C	-	W	T	U	switch	Low
491	KNX Channel 1-...	Red brightness, status			1 byte	C	-	W	T	U	percentage (0..100%)	Low
492	KNX Channel 1-...	Green brightness, status			1 byte	C	-	W	T	U	percentage (0..100%)	Low
493	KNX Channel 1-...	Blue brightness, status			1 byte	C	-	W	T	U	percentage (0..100%)	Low
494	KNX Channel 1-...	White brightness, status			1 byte	C	-	W	T	U	percentage (0..100%)	Low

RGBW_4x1byte

Number ^	Name	Object Function	Description	Group Address	Length	C	R	W	T	U	Data Type	Priority
483	KNX Channel 1-...	Device online, status			1 bit	C	-	W	T	U	switch	Low
484	KNX Channel 1-...	Locking object			1 bit	C	-	W	-	-	enable	Low
485	KNX Channel 1-...	Switch			1 bit	C	-	-	T	-	switch	Low
486	KNX Channel 1-...	RGBW dimming value			6 bytes	C	-	-	T	-	RGBW value 4x(0..100%)	Low
490	KNX Channel 1-...	Switch, status			1 bit	C	-	W	T	U	switch	Low
491	KNX Channel 1-...	RGBW brightness, status			6 bytes	C	-	W	T	U	RGBW value 4x(0..100%)	Low

RGBW_1x6byte

Number ^	Name	Object Function	Description	Group Address	Length	C	R	W	T	U	Data Type	Priority
483	KNX Channel 1-...	Device online, status			1 bit	C	-	W	T	U	switch	Low
484	KNX Channel 1-...	Locking object			1 bit	C	-	W	-	-	enable	Low
485	KNX Channel 1-...	Switch			1 bit	C	-	-	T	-	switch	Low
486	KNX Channel 1-...	Red dimming value			1 byte	C	-	-	T	-	percentage (0..100%)	Low
487	KNX Channel 1-...	Green dimming value			1 byte	C	-	-	T	-	percentage (0..100%)	Low
488	KNX Channel 1-...	Blue dimming value			1 byte	C	-	-	T	-	percentage (0..100%)	Low
489	KNX Channel 1-...	Absolute colour temperature			2 bytes	C	-	-	T	-	absolute colour tempe...	Low
490	KNX Channel 1-...	Switch, status			1 bit	C	-	W	T	U	switch	Low
491	KNX Channel 1-...	Red brightness, status			1 byte	C	-	W	T	U	percentage (0..100%)	Low
492	KNX Channel 1-...	Green brightness, status			1 byte	C	-	W	T	U	percentage (0..100%)	Low
493	KNX Channel 1-...	Blue brightness, status			1 byte	C	-	W	T	U	percentage (0..100%)	Low
494	KNX Channel 1-...	Absolute colour temperature, status			2 bytes	C	-	W	T	U	absolute colour tempe...	Low
495	KNX Channel 1-...	Brightness value			1 byte	C	-	-	T	-	percentage (0..100%)	Low
497	KNX Channel 1-...	Brightness, status			1 byte	C	-	W	T	U	percentage (0..100%)	Low

RGBCW_3x1byte_Normal

Number ^	Name	Object Function	Description	Group Address	Length	C	R	W	T	U	Data Type	Priority
483	KNX Channel 1-...	Device online, status			1 bit	C	-	W	T	U	switch	Low
484	KNX Channel 1-...	Locking object			1 bit	C	-	W	-	-	enable	Low
485	KNX Channel 1-...	Switch			1 bit	C	-	-	T	-	switch	Low
486	KNX Channel 1-...	Red dimming value			1 byte	C	-	-	T	-	percentage (0..100%)	Low
487	KNX Channel 1-...	Green dimming value			1 byte	C	-	-	T	-	percentage (0..100%)	Low
488	KNX Channel 1-...	Blue dimming value			1 byte	C	-	-	T	-	percentage (0..100%)	Low
490	KNX Channel 1-...	Switch, status			1 bit	C	-	W	T	U	switch	Low
491	KNX Channel 1-...	Red brightness, status			1 byte	C	-	W	T	U	percentage (0..100%)	Low
492	KNX Channel 1-...	Green brightness, status			1 byte	C	-	W	T	U	percentage (0..100%)	Low
493	KNX Channel 1-...	Blue brightness, status			1 byte	C	-	W	T	U	percentage (0..100%)	Low
494	KNX Channel 1-...	Absolute colour temperature, status			2 bytes	C	-	W	T	U	absolute colour tempe...	Low
495	KNX Channel 1-...	Warm white brightness			1 byte	C	-	-	T	-	percentage (0..100%)	Low
496	KNX Channel 1-...	Cool white brightness			1 byte	C	-	-	T	-	percentage (0..100%)	Low
497	KNX Channel 1-...	Brightness, status			1 byte	C	-	W	T	U	percentage (0..100%)	Low

RGBCW_3x1byte_Normal_Directly(..) &Brightness+Colour Temperature

Number ^	Name	Object Function	Description	Group Address	Length	C	R	W	T	U	Data Type	Priority
483	KNX Channel 1-...	Device online, status			1 bit	C	-	W	T	U	switch	Low
484	KNX Channel 1-...	Locking object			1 bit	C	-	W	-	-	enable	Low
485	KNX Channel 1-...	Switch			1 bit	C	-	-	T	-	switch	Low
486	KNX Channel 1-...	Red dimming value			1 byte	C	-	-	T	-	percentage (0..100%)	Low
487	KNX Channel 1-...	Green dimming value			1 byte	C	-	-	T	-	percentage (0..100%)	Low
488	KNX Channel 1-...	Blue dimming value			1 byte	C	-	-	T	-	percentage (0..100%)	Low
490	KNX Channel 1-...	Switch, status			1 bit	C	-	W	T	U	switch	Low
491	KNX Channel 1-...	Red brightness, status			1 byte	C	-	W	T	U	percentage (0..100%)	Low
492	KNX Channel 1-...	Green brightness, status			1 byte	C	-	W	T	U	percentage (0..100%)	Low
493	KNX Channel 1-...	Blue brightness, status			1 byte	C	-	W	T	U	percentage (0..100%)	Low
495	KNX Channel 1-...	Warm white brightness			1 byte	C	-	-	T	-	percentage (0..100%)	Low
496	KNX Channel 1-...	Cool white brightness			1 byte	C	-	-	T	-	percentage (0..100%)	Low
497	KNX Channel 1-...	Warm white brightness, status			1 byte	C	-	W	T	U	percentage (0..100%)	Low
498	KNX Channel 1-...	Cool white brightness, status			1 byte	C	-	W	T	U	percentage (0..100%)	Low

RGBCW_3x1byte_Normal_Directly(..) &Warm/Cool white brightness

Number ^	Name	Object Function	Description	Group Address	Length	C	R	W	T	U	Data Type	Priority
483	KNX Channel 1-...	Device online, status			1 bit	C	-	W	T	U	switch	Low
484	KNX Channel 1-...	Locking object			1 bit	C	-	W	-	-	enable	Low
485	KNX Channel 1-...	Switch			1 bit	C	-	-	T	-	switch	Low
486	KNX Channel 1-...	RGB dimming value			3 bytes	C	-	-	T	-	RGB value 3x(0..255)	Low
489	KNX Channel 1-...	Absolute colour temperature			2 bytes	C	-	-	T	-	absolute colour tempe...	Low
490	KNX Channel 1-...	Switch, status			1 bit	C	-	W	T	U	switch	Low
491	KNX Channel 1-...	RGB brightness, status			3 bytes	C	-	W	T	U	RGB value 3x(0..255)	Low
494	KNX Channel 1-...	Absolute colour temperature, status			2 bytes	C	-	W	T	U	absolute colour tempe...	Low
495	KNX Channel 1-...	Brightness value			1 byte	C	-	-	T	-	percentage (0..100%)	Low
497	KNX Channel 1-...	Brightness, status			1 byte	C	-	W	T	U	percentage (0..100%)	Low

RGBCW_1x3byte_Normal

Number ^	Name	Object Function	Description	Group Address	Length	C	R	W	T	U	Data Type	Priority
483	KNX Channel 1-...	Device online, status			1 bit	C	-	W	T	U	switch	Low
484	KNX Channel 1-...	Locking object			1 bit	C	-	W	-	-	enable	Low
485	KNX Channel 1-...	Switch			1 bit	C	-	-	T	-	switch	Low
486	KNX Channel 1-...	RGB dimming value			3 bytes	C	-	-	T	-	RGB value 3x(0..255)	Low
490	KNX Channel 1-...	Switch, status			1 bit	C	-	W	T	U	switch	Low
491	KNX Channel 1-...	RGB brightness, status			3 bytes	C	-	W	T	U	RGB value 3x(0..255)	Low
494	KNX Channel 1-...	Absolute colour temperature, status			2 bytes	C	-	W	T	U	absolute colour tempe...	Low
495	KNX Channel 1-...	Warm white brightness			1 byte	C	-	-	T	-	percentage (0..100%)	Low
496	KNX Channel 1-...	Cool white brightness			1 byte	C	-	-	T	-	percentage (0..100%)	Low
497	KNX Channel 1-...	Brightness, status			1 byte	C	-	W	T	U	percentage (0..100%)	Low

RGBCW_1x3byte_Directly(..) &Brightness+Colour Temperature

Number ^	Name	Object Function	Description	Group Address	Length	C	R	W	T	U	Data Type	Priority
483	KNX Channel 1-...	Device online, status			1 bit	C	-	W	T	U	switch	Low
484	KNX Channel 1-...	Locking object			1 bit	C	-	W	-	-	enable	Low
485	KNX Channel 1-...	Switch			1 bit	C	-	-	T	-	switch	Low
486	KNX Channel 1-...	RGB dimming value			3 bytes	C	-	-	T	-	RGB value 3x(0..255)	Low
490	KNX Channel 1-...	Switch, status			1 bit	C	-	W	T	U	switch	Low
491	KNX Channel 1-...	RGB brightness, status			3 bytes	C	-	W	T	U	RGB value 3x(0..255)	Low
495	KNX Channel 1-...	Warm white brightness			1 byte	C	-	-	T	-	percentage (0..100%)	Low
496	KNX Channel 1-...	Cool white brightness			1 byte	C	-	-	T	-	percentage (0..100%)	Low
497	KNX Channel 1-...	Warm white brightness, status			1 byte	C	-	W	T	U	percentage (0..100%)	Low
498	KNX Channel 1-...	Cool white brightness, status			1 byte	C	-	W	T	U	percentage (0..100%)	Low

RGBCW_1x3byte_Directly(..) &Warm/Cool white brightness

Number ^	Name	Object Function	Description	Group Address	Length	C	R	W	T	U	Data Type	Priority
483	KNX Channel 1-...	Device online, status			1 bit	C	-	W	T	U	switch	Low
484	KNX Channel 1-...	Locking object			1 bit	C	-	W	-	-	enable	Low
485	KNX Channel 1-...	Switch			1 bit	C	-	-	T	-	switch	Low
490	KNX Channel 1-...	Switch, status			1 bit	C	-	W	T	U	switch	Low
494	KNX Channel 1-...	Absolute colour temperature, status			2 bytes	C	-	W	T	U	absolute colour tempe...	Low
495	KNX Channel 1-...	Warm white brightness			1 byte	C	-	-	T	-	percentage (0..100%)	Low
496	KNX Channel 1-...	Cool white brightness			1 byte	C	-	-	T	-	percentage (0..100%)	Low
497	KNX Channel 1-...	Brightness, status			1 byte	C	-	W	T	U	percentage (0..100%)	Low
495	KNX Channel 1-...	Warm white brightness			1 byte	C	-	-	T	-	percentage (0..100%)	低
496	KNX Channel 1-...	Cool white brightness			1 byte	C	-	-	T	-	percentage (0..100%)	低
497	KNX Channel 1-...	Warm white brightness, status			1 byte	C	-	W	T	U	percentage (0..100%)	低
498	KNX Channel 1-...	Cool white brightness, status			1 byte	C	-	W	T	U	percentage (0..100%)	低

Colour temperature dimming

图 6.10.3 “Colour and colour temperature control”通讯对象

编号	名称	对象功能	类型	属性	DPT
48 6	KNX Channel X-{{...}}	RGB dimming value	3byte e	C,T	232.600 RGB value 3x(0..255)
49 1	KNX Channel X-{{...}}	RGB brightness, status	3byte e	C,W,T, U	232.600 RGB value 3x(0..255)

这两个通讯对象在 RGB 对象类型选择 1x3byte 或者 RGBCW 对象类型选择 1x3byte 时可见，适用于多色灯的亮度控制。

Obj.486: 用于发送 RGB 三色灯的亮度值到总线上。

Obj.491: 用于接收总线上 RGB 三色灯的亮度值的报文。

3 字节的 RGB 调光对象数据类型的编码: U8 U8 U8, 详情如下:

3 _{MSB}	2	1 _{LSB}
R	G	B
UUUUUUUU	UUUUUUUU	UUUUUUUU

R: 红色调光值; G: 绿色调光值; B: 蓝色调光值。

48 6	KNX Channel X-{{...}}	RGBW dimming value	6byte e	C,T	251.600 DPT_Colour_RGBW
49 1	KNX Channel X-{{...}}	RGBW brightness, status	6byte e	C,W,T, U	251.600 DPT_Colour_RGBW

这两个通讯对象在 RGBW 对象类型选择 1x6byte 时可见，适用于多色灯的亮度控制。

Obj.486: 用于发送 RGBW 四色灯的亮度值到总线上。

Obj.491: 用于接收总线上 RGBW 四色灯的亮度值的报文。

6 字节的 RGBW 调光对象数据类型的编码: U8 U8 U8 U8 R8 R4 B4, 详情如下:

6 _{MSB}	5	4	3	2	1 _{LSB}
R	G	B	W	保留	r r r r mR mG mB mW
UUUUUUUU	UUUUUUUU	UUUUUUUU	UUUUUUUU	000000 00	0000BBBB

R: 红色调光值; G: 绿色调光值; B: 蓝色调光值; W: 白色调光值;

mR: 决定红色的调光值是否有效, 0=无效, 1=有效;

mG: 决定绿色的调光值是否有效, 0=无效, 1=有效;

mB: 决定蓝色的调光值是否有效, 0=无效, 1=有效;

mW: 决定白色的调光值是否有效, 0=无效, 1=有效。

48	KNX Channel	Red dimming	1byte	C,T	5.001
6	X-{{...}}	value	e		percentage(0..100%)
49	KNX Channel	Red brightness,	1byte	C,W,T,	5.001
1	X-{{...}}	status	e	U	percentage(0..100%)

这两个通讯对象在 RGB 对象选择类型 3x1byte 或 RGBW 对象类型选择 4x1byte 时可见, 适用于灯的亮度控制。报文值: 0...100%

Obj.486: 用于发送控制 R (红色)通道的亮度值到总线上。

Obj.491: 用于接收总线上 R (红色)通道反馈的亮度状态。

48	KNX Channel	Green dimming	1byte	C,T	5.001
7	X-{{...}}	value	e		percentage(0..100%)
49	KNX Channel	Green brightness,	1byte	C,W,T,	5.001

2	X-{{...}}	status	e	U	percentage(0..100%)
<p>这两个通讯对象在 RGB 对象选择类型 3x1byte 或 RGBW 对象类型选择 4x1byte 时可见，适用于灯的亮度控制，也支持色温调节。报文值：0...100%</p> <p>Obj.487：用于发送控制 G(绿色)通道的亮度值到总线上。</p> <p>Obj.492：用于接收总线上 G(绿色)通道反馈的亮度状态。</p>					
48	KNX Channel	Blue dimming	1byt	C,T	5.001
8	X-{{...}}	value	e		percentage(0..100%)
49	KNX Channel	Blue brightness,	1byt	C,W,T,	5.001
3	X-{{...}}	status	e	U	percentage(0..100%)
<p>这两个通讯对象在 RGB 对象选择类型 3x1byte 或 RGBW 对象类型选择 4x1byte 时可见，适用于灯的亮度控制。报文值：0...100%</p> <p>Obj.488：用于发送控制 B(蓝色)通道的亮度值到总线上。</p> <p>Obj.493：用于接收总线上 B(蓝色)通道反馈的的亮度状态。</p>					
48	KNX Channel	White dimming	1byt	C,T	5.001
9	X-{{...}}	value	e		percentage(0..100%)
49	KNX Channel	White brightness,	1byt	C,W,T,	5.001
4	X-{{...}}	status	e	U	percentage(0..100%)
<p>这两个通讯对象在 RGBW 对象类型选择 4x1byte 时可见，适用于灯的亮度控制。</p>					

报文值：0...100%

Obj.489：用于发送控制 W(白色)通道的亮度值到总线上。

Obj.494：用于接收总线上 W(白色)通道反馈的的亮度状态。

489	KNX Channel X-{{...}}	Absolute colour temperature Percentage colour temperature	2byte e 1byte e	C,T	7.600 absolute colour temperature 5.001 percentage(0..100 %)
------------	------------------------------	----------------------------------------------------------------------------	------------------------------------------------------	------------	-------------------------------------------------------------------------------

该通讯对象适用于双色灯的色温调节。报文值：2000...7000 K

普通控制下，用于发送色温控制报文到总线上。

494	KNX Channel X-{{...}}	Absolute colour temperature, status	2byte e	C,W,T, U	7.600 absolute colour temperature
------------	------------------------------	--------------------------------------------	--------------------------	-----------------	------------------------------------------

该通讯对象适用于双色灯的色温调节。报文值：2000...7000 K

普通或直接控制&（亮度值+色温值）下，用于接收总线上反馈色温状态的报文。

494	KNX Channel X-{{...}}	Percentage colour temperature, status	1byte e	C,W,T, U	5.001 percentage(0..100 %)
------------	------------------------------	----------------------------------------------	--------------------------	-----------------	-----------------------------------

该通讯对象适用于双色灯的色温调节。报文值：2000...7000 K

普通控制下，用于接收总线上反馈色温状态的报文。

495	KNX Channel X-{{...}}	Brightness value	1byte e	C,T	5.001 percentage(0..100 %)
------------	------------------------------	-------------------------	--------------------------	------------	-----------------------------------

						%)
49 7	KNX X-{{...}}	Channel Brightness, status	1byt e	C,W,T, U	5.001 percentage(0..100 %)	
<p>这两个通讯对象适用于单色灯/双色灯的亮度控制。报文值：0...100%</p> <p>Obj.495：普通控制下，用于发送调光报文到总线上，即发送亮度值。</p> <p>Obj.497：普通控制或直接控制&（亮度值+色温值）下，用于接收调光器回应的灯光亮度状态。</p>						
49 5	KNX X-{{...}}	Channel Warm white brightness	1byt e	C,T	5.001 percentage(0..100 %)	
49 7	KNX X-{{...}}	Channel Warm white brightness, status	1byt e	C,W,T, U	5.001 percentage(0..100 %)	
<p>这两个通讯对象适用于直接控制下双色灯的暖白亮度控制。报文值：0...100%</p> <p>Obj.495：直接控制下，用于发送暖白调光报文到总线上，即发送暖白亮度值。</p> <p>Obj.497：直接控制&（暖/冷白亮度）下，用于接收调光器回应的暖白灯亮度状态。</p>						
49 6	KNX X-{{...}}	Channel Cool white brightness	1byt e	C,T	5.001 percentage(0..100 %)	
49 8	KNX X-{{...}}	Channel Cool white brightness, status	1byt e	C,W,T, U	5.001 percentage(0..100 %)	
<p>这两个通讯对象适用于直接控制下双色灯的冷白亮度控制。报文值：0...100%</p>						

Obj.496: 直接控制下, 用于发送冷白调光报文到总线上, 即发送冷白亮度值。

Obj.498: 直接控制&(暖/冷白亮度)下, 用于接收调光器回应的冷白灯亮度状态。

48	KNX Channel	Switch	1bit	C,T	1.001 switch
5	X-{{...}}				
49	KNX Channel	Switch, status	1bit	C,W,T,	1.001 switch
0	X-{{...}}			U	

这两个通讯对象适用于控制灯的开关。报文值:

0——关灯

1——开灯

Obj.485: 用于发送开/关报文到总线上, 控制灯的开/关。

Obj.490: 用于接收其它总线设备回应的开/关状态。

表 6.10.3 “Colour and colour temperature control”通讯对象

6.10.4 “Blind”通讯对象

485	KNX Channel 1-...	Open/Close	1 bit	C - - T -	open/close	低
486	KNX Channel 1-...	Stop	1 bit	C - - T -	step	低
487	KNX Channel 1-...	Curtain position	1 byte	C - - T -	percentage (0..100%)	低
490	KNX Channel 1-...	Curtain position, status	1 byte	C - W T U	percentage (0..100%)	低

Curtain position

485	KNX Channel 1-...	Up/Down	1 bit	C - - T -	up/down	低
486	KNX Channel 1-...	Stop	1 bit	C - - T -	step	低
487	KNX Channel 1-...	Blind position	1 byte	C - - T -	percentage (0..100%)	低
490	KNX Channel 1-...	Blind position, status	1 byte	C - W T U	percentage (0..100%)	低

Roller blind position

485	KNX Channel 1-...	Up/Down	1 bit	C - - T -	up/down	低
486	KNX Channel 1-...	Stop/Slat adj.	1 bit	C - - T -	step	低
487	KNX Channel 1-...	Blind position	1 byte	C - - T -	percentage (0..100%)	低
488	KNX Channel 1-...	Slat position	1 byte	C - - T -	percentage (0..100%)	低
490	KNX Channel 1-...	Blind position, status	1 byte	C - W T U	percentage (0..100%)	低
491	KNX Channel 1-...	Slat position, status	1 byte	C - W T U	percentage (0..100%)	低

Venetian blind position and slat

485	KNX Channel 1-...	Open/Close	1 bit	C - - T -	open/close	低
486	KNX Channel 1-...	Stop	1 bit	C - - T -	step	低

Curtain step/move

485	KNX Channel 1-...	Up/Down	1 bit	C - - T -	up/down	低
486	KNX Channel 1-...	Stop	1 bit	C - - T -	step	低

Roller blind step/move

图 6.10.4 “Blind”通讯对象

编号	名称	对象功能	类型	属性	DPT
485	KNX Channel X-{{...}}	Open/Close	1bit	C,T	1.009 open/close
486	KNX Channel X-{{...}}	Stop	1bit	C,T	1.007 step
487	KNX Channel X-{{...}}	Curtain position	1byte	C,T	5.001 percentage(0..100%)
490	KNX Channel X-{{...}}	Curtain position, status	1byte	C,W,T,U	5.001 percentage(0..100%)

Curtain position: 适用于开合帘。支持打开、关闭、停止、位置调整 and 位置状态反馈。

Obj.485: 用于发送控制开合帘开/闭的报文到总线上。报文值:

1——关闭窗帘

0——打开窗帘

Obj.486: 用于发送停止窗帘移动的报文到总线上。报文值:

0/1——停止

Obj.487: 用于发送控制窗帘位置的报文到总线上。报文值: 0...100%

Obj.490: 用于接收总线上窗帘执行器回应的窗帘位置状态。报文值: 0...100%

485	KNX X-{{...}}	Channel	Up/Down	1bit	C,T	1.008 up/down
486	KNX X-{{...}}	Channel	Stop	1bit	C,T	1.007 step
487	KNX X-{{...}}	Channel	Blind position	1byte	C,T	5.001 percentage(0..100%)
490	KNX X-{{...}}	Channel	Blind position, status	1byte	C,W,T, U	5.001 percentage(0..100%)

Roller blind position: 适用于卷帘, 不带百叶。支持打开、关闭、停止、位置调整和位置状态反馈。

Obj.485: 该通讯对象用于发送控制升降帘开/闭的报文到总线上。报文值:

1——向下关闭窗帘

0——向上打开窗帘

Obj.487: 用于发送控制卷帘位置的报文到总线上。报文值: 0...100%

Obj.490: 用于接收总线上卷帘执行器回应的窗帘位置状态。报文值: 0...100%

Obj.486 同上。						
485	KNX Channel X-{{...}}	Up/Down	1bit	C,T	1.008 up/down	
486	KNX Channel X-{{...}}	Stop/Slat adj.	1bit	C,T	1.007 step	
487	KNX Channel X-{{...}}	Blind position	1byte	C,T	5.001 percentage(0..100 %)	
488	KNX Channel X-{{...}}	Slat position	1byte	C,T	5.001 percentage(0..100 %)	
490	KNX Channel X-{{...}}	Blind position, status	1byte	C,W,T, U	5.001 percentage(0..100 %)	
491	KNX Channel X-{{...}}	Slat position, status	1byte	C,W,T, U	5.001 percentage(0..100 %)	
<p>Venetian blind position and slat 功能：适用于百叶帘，带百叶角度调整。支持打开、关闭、停止、位置和角度调整、位置和角度状态反馈</p> <p>Obj.486、Obj.487 和 Obj.490 同上。</p> <p>Obj.486：用于向总线发送停止窗帘移动或调整百叶角度的报文。报文值：</p> <p>1——停止/下调百叶角度</p> <p>0——停止/上调百叶角度</p>						

485	KNX	Channel	Open/Close	1bit	C, T	1.009 open/close
		X-{{...}}				
486	KNX	Channel	Stop	1bit	C, T	1.007 step
		X-{{...}}				
<p>Curtain step/move: 这两个通讯对象适用于开合帘。支持打开、关闭、停止。</p> <p>Obj.485: 该通讯对象用于发送控制开合帘开/闭的报文到总线上。报文值:</p> <p style="padding-left: 40px;">1——关闭窗帘</p> <p style="padding-left: 40px;">0——打开窗帘</p> <p>Obj.486: 该通讯对象用于向总线发送停止窗帘移动的报文。报文值:</p> <p style="padding-left: 40px;">0/1——停止</p>						
485	KNX	Channel	Up/Down	1bit	C, T	1.008 up/down
		X-{{...}}				
486	KNX	Channel	Stop	1bit	C, T	1.007 step
		X-{{...}}				
<p>Roller blind step/move: 这两个通讯对象适用于卷帘。支持打开、关闭、停止。</p> <p>Obj.485: 该通讯对象用于发送控制卷帘开/闭的报文到总线上。报文值:</p> <p style="padding-left: 40px;">1——向下关闭窗帘</p> <p style="padding-left: 40px;">0——向上打开窗帘</p> <p>Obj.486 同上。</p>						

表 6.10.4 “Blind”通讯对象

6.10.5 “Air conditioner”通讯对象

Number ^	Name	Object Function	Description	Group Address	Length	C	R	W	T	U	Data Type	Priority
483	KNX Channel 1-...	Device online, status			1 bit	C	-	W	T	U	switch	Low
484	KNX Channel 1-...	Locking object			1 bit	C	-	W	-	-	enable	Low
485	KNX Channel 1-...	Power on/off			1 bit	C	-	-	T	-	switch	Low
486	KNX Channel 1-...	Current setpoint adjustment			2 bytes	C	-	-	T	-	temperature (°C)	Low
488	KNX Channel 1-...	Fan speed			1 byte	C	-	-	T	-	percentage (0..100%)	Low
491	KNX Channel 1-...	Control mode			1 byte	C	-	-	T	-	HVAC control mode	Low
492	KNX Channel 1-...	Power on/off, status			1 bit	C	-	W	T	U	switch	Low
493	KNX Channel 1-...	External temperature sensor			2 bytes	C	-	W	T	U	temperature (°C)	Low
494	KNX Channel 1-...	Current temperature setpoint, status			2 bytes	C	-	W	T	U	temperature (°C)	Low
496	KNX Channel 1-...	Fan speed, status			1 byte	C	-	W	T	U	percentage (0..100%)	Low
498	KNX Channel 1-...	Control mode, status			1 byte	C	-	W	T	U	HVAC control mode	Low
500	KNX Channel 1-...	Timer			1 bit	C	-	W	-	-	enable	Low

Air conditioner

485	KNX Channel 1-...	Power on/off	1 bit	C	-	-	T	-	switch	低
486	KNX Channel 1-...	Current setpoint adjustment	1 byte	C	-	-	T	-	counter pulses (0..255)	低
488	KNX Channel 1-...	Fan speed	1 byte	C	-	-	T	-	percentage (0..100%)	低
489	KNX Channel 1-...	Vanes swing (1-swing,0-stop)	1 bit	C	-	-	T	-	start/stop	低
491	KNX Channel 1-...	Control mode	1 byte	C	-	-	T	-	HVAC control mode	低
492	KNX Channel 1-...	Power on/off, status	1 bit	C	-	W	T	U	switch	低
493	KNX Channel 1-...	External temperature sensor	2 bytes	C	-	W	T	U	temperature (°C)	低
494	KNX Channel 1-...	Current temperature setpoint, status	1 byte	C	-	W	T	U	counter pulses (0..255)	低
496	KNX Channel 1-...	Fan speed, status	1 byte	C	-	W	T	U	percentage (0..100%)	低
497	KNX Channel 1-...	Vanes swing (1-swing,0-stop), status	1 bit	C	-	W	T	U	start/stop	低
498	KNX Channel 1-...	Control mode, status	1 byte	C	-	W	T	U	HVAC control mode	低
500	KNX Channel 1-...	Timer	1 bit	C	-	W	-	-	enable	低

Air conditioner(with swing)

图 6.10.5 “Air conditioner”通讯对象

编号	名称	对象功能	类型	属性	DPT
48	KNX Channel	Power on/off	1bit	C,T	1.001 switch
5	X-{{...}}				

该通讯对象用于发送空调的开关报文到 KNX 总线上						
48	KNX	Channel	Current setpoint	2byte	C,T	9.001
6	X-{{...}}		adjustment	e		temperature
				1byte		5.010 counter
				e		pulses
<p>该通讯对象用于调节设定温度值，并且发送报文值到总线上。</p> <p>注：对象类型由参数设置，2byte 适用于 KNX 标准；1byte 为 KNX 非标，通常适用于一些自定义控制类，报文值为实际温度值，比如 17℃的报文值为 17（十进制数）。</p>						
48	KNX	Channel	Fan speed	1byte	C,T	5.001 percentage
8	X-{{...}}			e		5.100 fan stage
该通讯对象用于发送各档风速的控制报文到总线上。报文值由参数设置的数据类型决定						
48	KNX	Channel	Vanes swing	1bit	C,T	1.010 start/stop
9	X-{{...}}		(1-swing,0-stop)			
选择“Air conditioner(with swing)”时该通讯对象时可见。用于发送控制风速摆动的报文到总线上。						
49	KNX	Channel	Control mode	1byte	C,T	20.105 HVAC
1	X-{{...}}			e		control mode
<p>该通讯对象用于发送空调各模式的控制报文到总线上。不同的报文值意味着不同的工作模式：</p> <p>0-自动，1-加热，3-制冷，9-送风，14-除湿，其他保留。</p>						
49	KNX	Channel	Power on/off, status	1bit	C,	1.001 switch
2	X-{{...}}				W,	
					T,U	
<p>该通讯对象用于接收总线上空调的开关状态，并反馈到屏上显示。报文值：</p> <p>1——开机</p>						

0——关机						
49 3	KNX X-{{...}}	Channel	External temperature sensor	2byte	C, W, T,U	9.001 temperature
该通讯对象用于接收总线上室内温度传感器发送来的温度测量值，并在屏上显示室内温度。						
49 4	KNX X-{{...}}	Channel	Current temperature setpoint, status	2byte 1byte	C, W, T,U	9.001 temperature 5.010 counter pulses
该通讯对象用于接收总线上的当前设定温度值，并反馈到屏上显示。						
49 6	KNX X-{{...}}	Channel	Fan speed, status	1byte	C, W, T,U	5.001 percentage 5.100 fan stage
该通讯对象用于接收总线上当前的风速，并反馈到屏上显示。报文值由参数设置的数据类型决定。						
49 7	KNX X-{{...}}	Channel	Vanes swing (1-swing,0-stop), status	1bit	C, W, T,U	1.010 start/stop
选择“Air conditioner(with swing)”时该通讯对象可见。用于接收总线上叶片摆动的状态。报文值： 1——摆动风向 0——固定风向						
49 8	KNX X-{{...}}	Channel	Control mode, status	1byte	C, W, T,U	20.105 HVAC control mode

该通讯对象用于接收总线上当前的控制模式，并反馈到屏上显示。不同的报文值意味着不同的工作模式：0-自动，1-加热，3-制冷，9-送风，14-除湿，其他保留。

500	KNX Channel X-{{...}}	Timer	1bit	C, W	1.003 enable
<p>定时使能时该通讯对象可见。用于通过总线启用定时，或关闭定时。报文值：</p> <p>1-启用定时</p> <p>2-关闭定时</p>					

表 6.10.5 “Air conditioner”通讯对象

6.10.6 “Room temperature unit control”通讯对象

Number ^	Name	Object Function	Description	Group Address	Length	C	R	W	T	U	Data Type	Priority
483	KNX Channel 1-...	Device online, status			1 bit	C	-	W	T	U	switch	Low
484	KNX Channel 1-...	Locking object			1 bit	C	-	W	-	-	enable	Low
486	KNX Channel 1-...	Current setpoint adjustment			2 bytes	C	-	-	T	-	temperature (°C)	Low
487	KNX Channel 1-...	Current setpoint adjustment(1bit)			1 bit	C	-	-	T	-	step	Low
490	KNX Channel 1-...	Heating/Cooling mode			1 bit	C	-	-	T	-	cooling/heating	Low
493	KNX Channel 1-...	External temperature sensor			2 bytes	C	-	W	T	U	temperature (°C)	Low
494	KNX Channel 1-...	Current setpoint adjustment, status			2 bytes	C	-	W	T	U	temperature (°C)	Low
495	KNX Channel 1-...	Current setpoint display, status			2 bytes	C	-	W	T	U	temperature (°C)	Low
498	KNX Channel 1-...	Heating/Cooling mode, status			1 bit	C	-	W	T	U	cooling/heating	Low
500	KNX Channel 1-...	Timer			1 bit	C	-	W	-	-	enable	Low

Room temperature unit

Number ^	Name	Object Function	Description	Group Address	Length	C	R	W	T	U	Data Type	Priority
483	KNX Channel 1-...	Device online, status			1 bit	C	-	W	T	U	switch	Low
484	KNX Channel 1-...	Locking object			1 bit	C	-	W	-	-	enable	Low
485	KNX Channel 1-...	Power on/off			1 bit	C	-	-	T	-	switch	Low
486	KNX Channel 1-...	Current setpoint adjustment			2 bytes	C	-	-	T	-	temperature (°C)	Low
487	KNX Channel 1-...	Current setpoint adjustment(1bit)			1 bit	C	-	-	T	-	step	Low
490	KNX Channel 1-...	Heating/Cooling mode			1 bit	C	-	-	T	-	cooling/heating	Low
492	KNX Channel 1-...	Power on/off, status			1 bit	C	-	W	-	-	switch	Low
493	KNX Channel 1-...	External temperature sensor			2 bytes	C	-	W	T	U	temperature (°C)	Low
494	KNX Channel 1-...	Current setpoint adjustment, status			2 bytes	C	-	W	T	U	temperature (°C)	Low
495	KNX Channel 1-...	Current setpoint display, status			2 bytes	C	-	W	T	U	temperature (°C)	Low
498	KNX Channel 1-...	Heating/Cooling mode, status			1 bit	C	-	W	T	U	cooling/heating	Low
500	KNX Channel 1-...	Timer			1 bit	C	-	W	-	-	enable	Low

Room temperature unit(with on/off)

Number ^	Name	Object Function	Description	Group Address	Length	C	R	W	T	U	Data Type	Priority
483	KNX Channel 1-...	Device online, status			1 bit	C	-	W	T	U	switch	Low
484	KNX Channel 1-...	Locking object			1 bit	C	-	W	-	-	enable	Low
486	KNX Channel 1-...	Current setpoint adjustment			2 bytes	C	-	-	T	-	temperature (°C)	Low
487	KNX Channel 1-...	Current setpoint adjustment(1bit)			1 bit	C	-	-	T	-	step	Low
490	KNX Channel 1-...	Heating/Cooling mode			1 bit	C	-	-	T	-	cooling/heating	Low
491	KNX Channel 1-...	Operation mode			1 byte	C	-	-	T	-	HVAC mode	Low
493	KNX Channel 1-...	External temperature sensor			2 bytes	C	-	W	T	U	temperature (°C)	Low
494	KNX Channel 1-...	Current setpoint adjustment, status			2 bytes	C	-	W	T	U	temperature (°C)	Low
495	KNX Channel 1-...	Current setpoint display, status			2 bytes	C	-	W	T	U	temperature (°C)	Low
498	KNX Channel 1-...	Heating/Cooling mode, status			1 bit	C	-	W	T	U	cooling/heating	Low
499	KNX Channel 1-...	Operation mode, status			1 byte	C	-	W	T	U	HVAC mode	Low
500	KNX Channel 1-...	Timer			1 bit	C	-	W	-	-	enable	Low

Room temperature unit(with operation mode)

Number ^	Name	Object Function	Description	Group Address	Length	C	R	W	T	U	Data Type	Priority
483	KNX Channel 1-...	Device online, status			1 bit	C	-	W	T	U	switch	Low
484	KNX Channel 1-...	Locking object			1 bit	C	-	W	-	-	enable	Low
485	KNX Channel 1-...	Power on/off			1 bit	C	-	-	T	-	switch	Low
486	KNX Channel 1-...	Current setpoint adjustment			2 bytes	C	-	-	T	-	temperature (°C)	Low
487	KNX Channel 1-...	Current setpoint adjustment(1bit)			1 bit	C	-	-	T	-	step	Low
490	KNX Channel 1-...	Heating/Cooling mode			1 bit	C	-	-	T	-	cooling/heating	Low
491	KNX Channel 1-...	Operation mode			1 byte	C	-	-	T	-	HVAC mode	Low
492	KNX Channel 1-...	Power on/off, status			1 bit	C	-	W	-	-	switch	Low
493	KNX Channel 1-...	External temperature sensor			2 bytes	C	-	W	T	U	temperature (°C)	Low
494	KNX Channel 1-...	Current setpoint adjustment, status			2 bytes	C	-	W	T	U	temperature (°C)	Low
495	KNX Channel 1-...	Current setpoint display, status			2 bytes	C	-	W	T	U	temperature (°C)	Low
498	KNX Channel 1-...	Heating/Cooling mode, status			1 bit	C	-	W	T	U	cooling/heating	Low
499	KNX Channel 1-...	Operation mode, status			1 byte	C	-	W	T	U	HVAC mode	Low
500	KNX Channel 1-...	Timer			1 bit	C	-	W	-	-	enable	Low

Room temperature unit(with on/off & operation mode)

Number *	Name	Object Function	Description	Group Address	Length	C	R	W	T	U	Data Type	Priority
483	KNX Channel 1-...	Device online, status			1 bit	C	-	W	T	U	switch	Low
484	KNX Channel 1-...	Locking object			1 bit	C	-	W	-	-	enable	Low
486	KNX Channel 1-...	Current setpoint adjustment			2 bytes	C	-	-	T	-	temperature (°C)	Low
487	KNX Channel 1-...	Current setpoint adjustment(1bit)			1 bit	C	-	-	T	-	step	Low
488	KNX Channel 1-...	Fan speed			1 byte	C	-	-	T	-	percentage (0..100%)	Low
490	KNX Channel 1-...	Heating/Cooling mode			1 bit	C	-	-	T	-	cooling/heating	Low
491	KNX Channel 1-...	Operation mode			1 byte	C	-	-	T	-	HVAC mode	Low
493	KNX Channel 1-...	External temperature sensor			2 bytes	C	-	W	T	U	temperature (°C)	Low
494	KNX Channel 1-...	Current setpoint adjustment, status			2 bytes	C	-	W	T	U	temperature (°C)	Low
495	KNX Channel 1-...	Current setpoint display, status			2 bytes	C	-	W	T	U	temperature (°C)	Low
496	KNX Channel 1-...	Fan speed, status			1 byte	C	-	W	T	U	percentage (0..100%)	Low
498	KNX Channel 1-...	Heating/Cooling mode, status			1 bit	C	-	W	T	U	cooling/heating	Low
499	KNX Channel 1-...	Operation mode, status			1 byte	C	-	W	T	U	HVAC mode	Low
500	KNX Channel 1-...	Timer			1 bit	C	-	W	-	-	enable	Low

Room temperature unit(with operation mode & fan speed)

Number *	Name	Object Function	Description	Group Address	Length	C	R	W	T	U	Data Type	Priority
483	KNX Channel 1-...	Device online, status			1 bit	C	-	W	T	U	switch	Low
484	KNX Channel 1-...	Locking object			1 bit	C	-	W	-	-	enable	Low
485	KNX Channel 1-...	Power on/off			1 bit	C	-	-	T	-	switch	Low
486	KNX Channel 1-...	Current setpoint adjustment			2 bytes	C	-	-	T	-	temperature (°C)	Low
487	KNX Channel 1-...	Current setpoint adjustment(1bit)			1 bit	C	-	-	T	-	step	Low
488	KNX Channel 1-...	Fan speed			1 byte	C	-	-	T	-	percentage (0..100%)	Low
490	KNX Channel 1-...	Heating/Cooling mode			1 bit	C	-	-	T	-	cooling/heating	Low
491	KNX Channel 1-...	Operation mode			1 byte	C	-	-	T	-	HVAC mode	Low
492	KNX Channel 1-...	Power on/off, status			1 bit	C	-	W	-	-	switch	Low
493	KNX Channel 1-...	External temperature sensor			2 bytes	C	-	W	T	U	temperature (°C)	Low
494	KNX Channel 1-...	Current setpoint adjustment, status			2 bytes	C	-	W	T	U	temperature (°C)	Low
495	KNX Channel 1-...	Current setpoint display, status			2 bytes	C	-	W	T	U	temperature (°C)	Low
496	KNX Channel 1-...	Fan speed, status			1 byte	C	-	W	T	U	percentage (0..100%)	Low
498	KNX Channel 1-...	Heating/Cooling mode, status			1 bit	C	-	W	T	U	cooling/heating	Low
499	KNX Channel 1-...	Operation mode, status			1 byte	C	-	W	T	U	HVAC mode	Low
500	KNX Channel 1-...	Timer			1 bit	C	-	W	-	-	enable	Low

Room temperature unit(with on/off & operation mode & fan speed)

图 6.10.6 “Room temperature unit control”通讯对象

编号	名称	对象功能	类型	属性	DPT
485	KNX Channel X-{{...}}	Power on/off	1bit	C,T	1.001 switch

该通讯对象用于发送温控的开关报文，控制 KNX 总线上温控的开关。

系统上电时需恢复到掉电前的状态且总线掉电恢复时需发送功能点的状态请求：控制模式、操作模式、风速、设定温度和外部温度传感器。

486	KNX	Channel	Current setpoint	2byte	C,T	9.001
	X-{{...}}		adjustment	e		temperature
<p>设定温度调整对象类型为 2byte 或者 1bit&定时使能时，该通讯对象可见。通过屏调节设定温度值，2byte 对象绝对调整设定温度值，并且发送报文值到总线上。</p>						
487	KNX	Channel	Current setpoint	1bit	C,T	1.007 step
	X-{{...}}		adjustment(1bit)			
<p>设定温度调整对象类型为 1bit 时，该通讯对象可见。通过屏调节设定温度值，1bit 对象适用于相对调整，并且发送报文值到总线上。</p> <p>1-上调设定温度</p> <p>0-下调设定温度</p>						
488	KNX	Channel	Fan speed	1byte	C,T	5.001
	X-{{...}}			e		percentage
						5.100 fan stage
<p>该通讯对象用于发送各档风速的控制报文到总线上。报文值由参数设置的数据类型决定</p>						
489	KNX	Channel	Fan automatic operation	1bit	C,T	1.003 enable
	X-{{...}}					
<p>风速自动控制使能时该通讯对象可见。用于发送风速的自动控制报文到总线上。报文值：</p> <p>1——激活自动</p> <p>0——退出自动</p>						
490	KNX	Channel	Heating/Cooling mode	1bit	C,T	1.100
	X-{{...}}					cooling/heatin

						g
<p>该通讯对象用于发送切换制冷和制热功能的报文到总线上。报文值：</p> <p>1——加热</p> <p>0——制冷</p>						
491	KNX	Channel	Operation mode	1byte	C,T	20.102 HVAC mode
		X-{{...}}		e		
<p>该通讯对象用于发送房间操作模式的报文到总线上。不同的报文值意味着不同的工作模式：</p> <p>1-舒适，2-待机，3-节能，4-保护，其他保留。</p>						
492	KNX	Channel	Power on/off, status	1bit	C,	1.001 switch
		X-{{...}}			W	
<p>该通讯对象用于接收总线上温控的开关状态，并反馈到屏上显示。报文值：</p> <p>1——开</p> <p>0——关</p>						
493	KNX	Channel	External temperature sensor	2byte	C,	9.001 temperature
		X-{{...}}		e	W,	
					T,U	
<p>选择外部传感器时该通讯对象可见。用于接收总线上的房间温度，及周期发送读请求，并反馈到屏上显示。</p>						
494	KNX	Channel	Current setpoint adjustment, status	2byte	C,	9.001 temperature
		X-{{...}}		e	W,	
					T,U	
<p>该通讯对象用于接收总线上的当前设定温度值，并反馈到屏上显示。</p>						

495	KNX	Channel	Current setpoint display, status	2byte	C, W, T,U	9.001 temperature
<p>参数“Interface display temperature”选择 Setpoint temperature 时该通讯对象可见。用于接收当前的温度设定值的反馈，并在屏上显示。</p>						
496	KNX	Channel	Fan speed, status	1byte	C, W, T,U	5.001 percentage 5.100 fan stage
<p>该通讯对象用于接收总线上当前的风速，并反馈到屏上显示。报文值由参数设置的数据类型决定。</p>						
497	KNX	Channel	Fan automatic operation, status	1bit	C, W, T,U	1.003 enable
<p>该对象用于接收风速自动控制的状态反馈。报文值：</p> <p>1——自动</p> <p>0——退出自动</p>						
498	KNX	Channel	Heating/Cooling mode, status	1bit	C, W, T,U	1.100 cooling/heating
<p>该通讯对象用于接收总线上加热和制冷的状态，并反馈到屏上显示。报文值：</p> <p>1——加热</p> <p>0——制冷</p>						
499	KNX	Channel	Operation mode, status	1byte	C,	20.102 HVAC

	X-{{...}}		e	W, T,U	mode
<p>该通讯对象用于接收总线上房间操作模式的报文。不同的报文值意味着不同的工作模式： 1-舒适，2-待机，3-节能，4-保护，其他保留。</p>					
500	KNX Channel X-{{...}}	Timer	1bit	C, W	1.003 enable
<p>定时功能使能时，该通讯对象时可见。用于通过总线启用/关闭定时。</p>					

表 6.10.6 “Room temperature control”通讯对象

6.10.7 “Ventilation system”通讯对象

Number ^	Name	Object Function	Description	Group Address	Length	C	R	W	T	U	Data Type	Priority
483	KNX Channel 1-...	Device online, status			1 bit	C	-	W	T	U	switch	Low
484	KNX Channel 1-...	Locking object			1 bit	C	-	W	-	-	enable	Low
485	KNX Channel 1-...	Power on/off			1 bit	C	-	-	T	-	switch	Low
486	KNX Channel 1-...	Filter timer counter			2 bytes	C	-	-	T	-	time (h)	Low
487	KNX Channel 1-...	Filter alarm			1 bit	C	-	-	T	-	alarm	Low
488	KNX Channel 1-...	Fan speed			1 byte	C	-	-	T	-	percentage (0..100%)	Low
490	KNX Channel 1-...	Heat recovery			1 bit	C	-	-	T	-	enable	Low
492	KNX Channel 1-...	Power on/off, status			1 bit	C	-	W	-	-	switch	Low
493	KNX Channel 1-...	Filter timer counter change			2 bytes	C	-	W	-	-	time (h)	Low
496	KNX Channel 1-...	Fan speed, status			1 byte	C	-	W	-	-	percentage (0..100%)	Low
498	KNX Channel 1-...	Heat recovery, status			1 bit	C	-	W	-	-	enable	Low
499	KNX Channel 1-...	Filter timer reset			1 bit	C	-	W	-	-	reset	Low

Ventilation system

Number ^	Name	Object Function	Description	Group Address	Length	C	R	W	T	U	Data Type	Priority
483	KNX Channel 1-...	Device online, status			1 bit	C	-	W	T	U	switch	Low
484	KNX Channel 1-...	Locking object			1 bit	C	-	W	-	-	enable	Low
485	KNX Channel 1-...	Power on/off			1 bit	C	-	-	T	-	switch	Low
486	KNX Channel 1-...	Filter timer counter			2 bytes	C	-	-	T	-	time (h)	Low
487	KNX Channel 1-...	Filter alarm			1 bit	C	-	-	T	-	alarm	Low
488	KNX Channel 1-...	Fan speed			1 byte	C	-	-	T	-	percentage (0..100%)	Low
489	KNX Channel 1-...	Fan automatic operation			1 bit	C	-	-	T	-	enable	Low
490	KNX Channel 1-...	Heat recovery			1 bit	C	-	-	T	-	enable	Low
492	KNX Channel 1-...	Power on/off, status			1 bit	C	-	W	-	-	switch	Low
493	KNX Channel 1-...	Filter timer counter change			2 bytes	C	-	W	-	-	time (h)	Low
494	KNX Channel 1-...	PM 2.5 value			2 bytes	C	-	W	T	U	pulses	Low
496	KNX Channel 1-...	Fan speed, status			1 byte	C	-	W	-	-	percentage (0..100%)	Low
497	KNX Channel 1-...	Fan automatic operation, status			1 bit	C	-	W	-	-	enable	Low
498	KNX Channel 1-...	Heat recovery, status			1 bit	C	-	W	-	-	enable	Low
499	KNX Channel 1-...	Filter timer reset			1 bit	C	-	W	-	-	reset	Low

Ventilation system(with auto fan speed)

图 6.10.7“Ventilation system”通讯对象

编号	名称	对象功能	类型	属性	DPT
485	KNX Channel X-{{...}}	Power on/off	1bit	C,T	1.001 switch
<p>该通讯对象用于发送新风控制的开关报文到 KNX 总线上。报文值：</p> <p>1——开机</p> <p>0——关机</p>					
486	KNX Channel X-{{...}}	Filter timer counter	2byte	C,T	7.007 time(h)
<p>该通讯对象用于计数滤网使用时长，当计数值改变时发送到总线上。滤网使用时长以小时为单位。</p>					
487	KNX Channel X-{{...}}	Filter alarm	1bit	C,T	1.005 alarm
<p>在滤网使用时长超出设定值时，该通讯对象发出警报，以便提醒用户更换滤网。报文值：</p> <p>1——警报</p> <p>0——无警报</p>					
488	KNX Channel X-{{...}}	Fan speed	1byte	C,T	5.001 percentage 5.100 fan stage
<p>该通讯对象用于发送各档风速的控制报文到总线上。报文值由参数设置的数据类型决定。</p>					
489	KNX Channel X-{{...}}	Fan automatic operation	1bit	C,T	1.003 enable
<p>在选择 Ventilation system(with auto fan speed)时该通讯对象可见，用于使能新风的自动操作功能。</p> <p>在设备上电复位或编程后，自动操作默认是没使能的。关机、手动调风速、场景可以把自动操作退出。</p> <p>没有参数定义，默认 1-激活，0-不激活。</p>					
490	KNX Channel	Heat recovery	1bit	C,T	1.003 enable

	X-{{...}}					
<p>参数“Heat recovery function”使能时该通讯对象可见，用于发送开/关新风热交换的控制命令。报文值：</p> <p style="text-align: center;">1——开</p> <p style="text-align: center;">0——关</p>						
492	KNX Channel X-{{...}}	Power on/off, status	1bit	C, W	1.001 switch	
<p>该通讯对象用于接收总线上新风控制开关状态的反馈。</p>						
493	KNX Channel X-{{...}}	Filter timer counter change	2byte	C, W	7.007 time(h)	
<p>参数“Filter timer counter”使能时显示该通讯对象可见。用于通过总线更改滤网使用时长。</p>						
494	KNX Channel X-{{...}}	CO2 value	2byte	C, W, T, U	7.001 pulse 9.030 concentration(ug/m3) 9.008 parts/million(ppm)	
<p>在选择 Ventilation system(with auto fan speed)时该通讯对象可见。数据点根据参数选项显示。</p> <p>该通讯对象用于接收 CO2 值的输入，从总线上获取相应的值更新到显示，单位为 ppm。范围： 0~4000ppm</p> <p>如果自动操作的控制值为 CO2，那么自动下，将可以设置新风系统根据 CO2 的浓度自动调整风速大小。</p>						
494	KNX Channel X-{{...}}	VOC value	2byte	C, W, T	7.001 pulse 9.030	

					,U	concentration(ug/m³) 9.008 parts/million(ppm)
<p>该通讯对象用于接收 VOC 值的输入，从总线上获取相应的值更新到显示，单位为 ppm。范围：0~4000ppm</p> <p>如果自动操作的控制值为 VOC，那么自动下，将可以设置新风系统根据 VOC 的浓度自动调整风速大小。</p>						
494	KNX Channel X-{{...}}	PM 2.5 value	2byte	C, W,T ,U	7.001 pulse 9.030 concentration(ug/m³) 9.008 parts/million(ppm)	
<p>该通讯对象用于接收 PM2.5 值的输入，从总线上获取相应的值更新到显示，单位为 ug/m³。范围：0~999ug/m³</p> <p>如果自动操作的控制值为 PM2.5，那么自动下，将可以设置新风系统根据 PM2.5 的浓度自动调整风速大小。</p>						
496	KNX Channel X-{{...}}	Fan speed, status	1byte	C, W	5.001 percentage 5.100 fan stage	
<p>该通讯对象用于接收风速的状态反馈。每档风速对应的具体报文值由参数定义。</p>						
497	KNX Channel X-{{...}}	Fan automatic operation, status	1bit	C, W	1.003 enable	
<p>选择 Ventilation system(with auto fan speed)时该通讯对象可见，用于接收反馈的风速自动控制状态到屏上。</p>						

498	KNX Channel X-{{...}}	Heat recovery, status	1bit	C, W	1.003 enable
<p>参数“Heat recovery function”使能时该通讯对象可见。用于接收总线上热交换开关状态的反馈，并更新到屏上显示。</p>					
499	KNX Channel X-{{...}}	Filter timer reset	1bit	C, W	1.015 reset
<p>参数“Filter timer counter”使能时该通讯对象可见。用于重置滤网时间，重置后，滤网使用时长重新开始计数。报文值：</p> <p style="text-align: center;">1——重置</p>					

表 6.10.7“Ventilation system”通讯对象

6.10.8 “Audio control”通讯对象

Number ^	Name	Object Function	Description	Group Address	Length	C	R	W	T	U	Data Type	Priority
483	KNX Channel 1-...	Device online, status			1 bit	C	-	W	T	U	switch	Low
484	KNX Channel 1-...	Locking object			1 bit	C	-	W	-	-	enable	Low
486	KNX Channel 1-...	Play=1/Pause=0			1 bit	C	-	-	T	-	start/stop	Low
488	KNX Channel 1-...	Next track=1/Previous track=0			1 bit	C	-	-	T	-	step	Low
490	KNX Channel 1-...	Volume+=1/Volume-=0			1 bit	C	-	-	T	-	step	Low
491	KNX Channel 1-...	Mute			1 bit	C	-	-	T	-	enable	Low
493	KNX Channel 1-...	Absolute volume			1 byte	C	-	-	T	-	percentage (0..100%)	Low
495	KNX Channel 1-...	Play=1/Pause=0, status			1 bit	C	-	W	T	U	start/stop	Low
497	KNX Channel 1-...	Volume, status			1 byte	C	-	W	T	U	percentage (0..100%)	Low
498	KNX Channel 1-...	Mute, status			1 bit	C	-	W	T	U	enable	Low

Audio control

Number ^	Name	Object Function	Description	Group Address	Length	C	R	W	T	U	Data Type	Priority
483	KNX Channel 1-...	Device online, status			1 bit	C	-	W	T	U	switch	Low
484	KNX Channel 1-...	Locking object			1 bit	C	-	W	-	-	enable	Low
485	KNX Channel 1-...	Power on/off			1 bit	C	-	-	T	-	switch	Low
486	KNX Channel 1-...	Play=1/Pause=0			1 bit	C	-	-	T	-	start/stop	Low
488	KNX Channel 1-...	Next track=1/Previous track=0			1 bit	C	-	-	T	-	step	Low
490	KNX Channel 1-...	Volume+=1/Volume-=0			1 bit	C	-	-	T	-	step	Low
491	KNX Channel 1-...	Mute			1 bit	C	-	-	T	-	enable	Low
494	KNX Channel 1-...	Power on/off, status			1 bit	C	-	W	-	-	switch	Low
495	KNX Channel 1-...	Play=1/Pause=0, status			1 bit	C	-	W	T	U	start/stop	Low
498	KNX Channel 1-...	Mute, status			1 bit	C	-	W	T	U	enable	Low

Audio control(with on/off)

Number ^	Name	Object Function	Description	Group Address	Length	C	R	W	T	U	Data Type	Priority
483	KNX Channel 1-...	Device online, status			1 bit	C	-	W	T	U	switch	Low
484	KNX Channel 1-...	Locking object			1 bit	C	-	W	-	-	enable	Low
486	KNX Channel 1-...	Play			1 bit	C	-	-	T	-	enable	Low
487	KNX Channel 1-...	Pause			1 bit	C	-	-	T	-	enable	Low
488	KNX Channel 1-...	Next track			1 bit	C	-	-	T	-	enable	Low
489	KNX Channel 1-...	Previous track			1 bit	C	-	-	T	-	enable	Low
490	KNX Channel 1-...	Volume+=1/Volume-=0			1 bit	C	-	-	T	-	step	Low
491	KNX Channel 1-...	Mute			1 bit	C	-	-	T	-	enable	Low
493	KNX Channel 1-...	Play mode			1 byte	C	-	-	T	-	counter pulses (0..255)	Low
495	KNX Channel 1-...	Play, status			1 bit	C	-	W	T	U	enable	Low
496	KNX Channel 1-...	Pause, status			1 bit	C	-	W	T	U	enable	Low
498	KNX Channel 1-...	Mute, status			1 bit	C	-	W	T	U	enable	Low
499	KNX Channel 1-...	Play mode, status			1 byte	C	-	W	T	U	counter pulses (0..255)	Low

Audio control(play mode)

Number ^	Name	Object Function	Description	Group Address	Length	C	R	W	T	U	Data Type	Priority
483	KNX Channel 1-...	Device online, status			1 bit	C	-	W	T	U	switch	Low
484	KNX Channel 1-...	Locking object			1 bit	C	-	W	-	-	enable	Low
486	KNX Channel 1-...	Play			1 bit	C	-	-	T	-	enable	Low
487	KNX Channel 1-...	Pause			1 bit	C	-	-	T	-	enable	Low
488	KNX Channel 1-...	Next track			1 bit	C	-	-	T	-	enable	Low
489	KNX Channel 1-...	Previous track			1 bit	C	-	-	T	-	enable	Low
490	KNX Channel 1-...	Volume+=1/Volume-=0			1 bit	C	-	-	T	-	step	Low
491	KNX Channel 1-...	Mute			1 bit	C	-	-	T	-	enable	Low
493	KNX Channel 1-...	Absolute volume			1 byte	C	-	-	T	-	percentage (0..100%)	Low
495	KNX Channel 1-...	Play, status			1 bit	C	-	W	T	U	enable	Low
496	KNX Channel 1-...	Pause, status			1 bit	C	-	W	T	U	enable	Low
497	KNX Channel 1-...	Volume, status			1 byte	C	-	W	T	U	percentage (0..100%)	Low
498	KNX Channel 1-...	Mute, status			1 bit	C	-	W	T	U	enable	Low
500	KNX Channel 1-...	Track name			14 bytes	C	-	W	T	U	Character String (ISO 8...	Low
501	KNX Channel 1-...	Album name			14 bytes	C	-	W	T	U	Character String (ISO 8...	Low
502	KNX Channel 1-...	Artist name			14 bytes	C	-	W	T	U	Character String (ISO 8...	Low

Audio control(track information)

Number ^	Name	Object Function	Description	Group Address	Length	C	R	W	T	U	Data Type	Priority
483	KNX Channel 1-...	Device online, status			1 bit	C	-	W	T	U	switch	Low
484	KNX Channel 1-...	Locking object			1 bit	C	-	W	-	-	enable	Low
486	KNX Channel 1-...	Play			1 bit	C	-	-	T	-	enable	Low
487	KNX Channel 1-...	Pause			1 bit	C	-	-	T	-	enable	Low
488	KNX Channel 1-...	Next track			1 bit	C	-	-	T	-	enable	Low
489	KNX Channel 1-...	Previous track			1 bit	C	-	-	T	-	enable	Low
490	KNX Channel 1-...	Volume+=1/Volume-=0			1 bit	C	-	-	T	-	step	Low
491	KNX Channel 1-...	Mute			1 bit	C	-	-	T	-	enable	Low
492	KNX Channel 1-...	Next playlist=1/Previous playlist=0			1 bit	C	-	-	T	-	step	Low
493	KNX Channel 1-...	Absolute volume			1 byte	C	-	-	T	-	percentage (0..100%)	Low
495	KNX Channel 1-...	Play, status			1 bit	C	-	W	T	U	enable	Low
496	KNX Channel 1-...	Pause, status			1 bit	C	-	W	T	U	enable	Low
497	KNX Channel 1-...	Volume, status			1 byte	C	-	W	T	U	percentage (0..100%)	Low
498	KNX Channel 1-...	Mute, status			1 bit	C	-	W	T	U	enable	Low
500	KNX Channel 1-...	Track name			14 bytes	C	-	W	T	U	Character String (ISO 8...Low	
501	KNX Channel 1-...	Album name			14 bytes	C	-	W	T	U	Character String (ISO 8...Low	
502	KNX Channel 1-...	Artist name			14 bytes	C	-	W	T	U	Character String (ISO 8...Low	
503	KNX Channel 1-...	Playlist name			14 bytes	C	-	W	T	U	Character String (ISO 8...Low	

Audio control(track information+playlist)

图 6.10.8 “Audio control”通讯对象

编号	名称	对象功能	类型	属性	DPT
485	KNX Channel X-{{...}}	Power on/off	1bit	C,T	1.001 switch
<p>开关机功能使能时，该通讯对象可见。用于发送背景音乐开/关控制的报文到 KNX 总线上。</p> <p>报文值：</p> <p>1——开机</p> <p>0——关机</p>					
486	KNX Channel X-{{...}}	Play=1/Pause=0 Play	1bit	C,T	1.010 start/stop
<p>控制播放/暂停共用 1 个对象时，该通讯对象可见。用于播放/暂停背景音乐模块中的音乐。报文值：</p> <p>1——播放音乐</p> <p>0——暂停音乐</p>					

486	KNX Channel X-{{...}}	Play	1bit	C,T	1.003 enable
<p>控制播放/暂停独立 2 个对象时, 该通讯对象可见。用于播放背景音乐模块中的音乐。报文值:</p> <p>1——播放音乐</p>					
487	KNX Channel X-{{...}}	Pause	1bit	C,T	1.003 enable
<p>控制播放/暂停独立 2 个对象时, 该通讯对象可见。该通讯对象用于暂停背景音乐模块中的音乐。</p> <p>报文值:</p> <p>1——播放音乐</p>					
488	KNX Channel X-{{...}}	Next track=1/Previous track=0	1bit	C,T	1.007 step
<p>控制切换下一首/上一首曲目共用 1 个对象时, 该通讯对象可见。用于切换背景音乐模块的播放歌曲, 切换到上一首/下一首歌曲。报文值:</p> <p>1——播放下一首歌曲</p> <p>0——播放上一首歌曲</p>					
488	KNX Channel X-{{...}}	Next track	1bit	C,T	1.003 enable
<p>控制切换下一首/上一首曲目独立 2 个对象时, 该通讯对象可见。用于切换背景音乐模块的播放歌曲, 切换到下一首歌曲。报文值:</p> <p>1——播放下一首歌曲</p>					
489	KNX Channel X-{{...}}	Previous track	1bit	C,T	1.003 enable

<p>控制切换下一首/上一首曲目独立 2 个对象时，该通讯对象可见。用于切换背景音乐模块的播放歌曲，切换到上一首歌曲。报文值：</p> <p>1——播放上一首歌曲</p>						
490	KNX	Channel	Volume+=1/Volume-=0	1bit	C,T	1.007 step
		X-{{...}}				
<p>1bit 时，该通讯对象用于调节背景音乐模块的音量。报文值：</p> <p>1——音量增</p> <p>0——音量减</p>						
493	KNX	Channel	Absolute volume	1byte	C,T	5.001
		X-{{...}}		e		percentage
						5.004
						percentage
<p>1byte 时，该通讯对象用于调节背景音乐模块的音量。</p> <p>报文值由不同的对象类型决定：0..100 / 0..255</p>						
491	KNX	Channel	Mute	1bit	C,T	1.003 enable
		X-{{...}}				
<p>静音使能时，该通讯对象可见。用于通过屏静音控制背景音乐。报文值：</p> <p>1——静音</p> <p>0——取消静音</p>						
492	KNX	Channel	Next playlist=1/Previous playlist=0	1bit	C,T	1.007 step
		X-{{...}}				
<p>控制切换下一首/上一首曲目共用 1 个对象时，该通讯对象可见。用于切换背景音乐模块的播放列表。</p>						

报文值： 1——播放下一个列表 0——播放上一个列表						
493	KNX	Channel	Play mode	1byte	C,T	5.010 counter pulses
		X-{{...}}		e		
该通讯对象用于发送背景音乐播放模式的控制报文，不同模式的报文由参数预设。						
494	KNX	Channel	Power on/off, status	1bit	C,W	1.001 switch
		X-{{...}}			,T,U	
开关机功能使能时，该通讯对象可见。用于接收来自总线上背景音乐开关状态的反馈。						
495	KNX	Channel	Play=1/Pause=0, status	1bit	C,W	1.010 start/stop
		X-{{...}}			,T,U	
该通讯对象用于接收总线上反馈的音乐播放/暂停状态，并反馈到屏上显示。						
495	KNX	Channel	Play, status	1bit	C,W	1.003 enable
		X-{{...}}			,T,U	
控制播放/暂停独立 2 个对象时，该通讯对象可见。用于接收总线上反馈的音乐播放状态，并反馈到屏上显示。报文值： 1——开启播放						
496	KNX	Channel	Pause, status	1bit	C,W	1.003 enable
		X-{{...}}			,T,U	
控制播放/暂停独立 2 个对象时，该通讯对象可见。用于接收总线上反馈的音乐暂停状态，并反馈到屏上显示。报文值：						

1——暂停播放						
497	KNX X-{{...}}	Channel	Volume, status	1byte	C,W ,T,U	5.001 percentage 5.004 percentage
1byte 时, 该通讯对象用于接收背景音乐模块的音量状态, 并反馈到屏上显示。 报文值由不同的对象类型决定: 0..100 / 0..255。						
498	KNX X-{{...}}	Channel	Mute, status	1bit	C,W ,T,U	1.003 enable
静音使能时, 该通讯对象可见。用于接收背景音乐模块的静音状态, 并反馈到屏上显示。						
499	KNX X-{{...}}	Channel	Play mode, status	1byte	C,W ,T,U	5.010 counter pulses
该通讯对象用于接收背景音乐播放模式的状态反馈报文, 接收的报文须为参数指定的报文才会更新屏上的显示状态。						
500	KNX X-{{...}}	Channel	Track name	14byte	C,W ,T,U	16.001 character string (ISO 8859-1)
该通讯对象用于通过总线接收歌曲名, 并在屏上显示。						
501	KNX X-{{...}}	Channel	Album name	14byte	C,W ,T,U	16.001 character string (ISO 8859-1)

该通讯对象用于通过总线接收专辑名，并在屏上显示。						
502	KNX	Channel	Artist name	14byte	C,W,T,U	16.001 character string (ISO 8859-1)
		X-{{...}}				
该通讯对象用于通过总线接收歌手名，并在屏上显示。						
503	KNX	Channel	Playlist name	14byte	C,W,T,U	16.001 character string (ISO 8859-1)
		X-{{...}}				
该通讯对象用于通过总线接收播放列表名，并在屏上显示。						

图 10.6.8 “Audio control”通讯对象

6.10.9 “Energy Metering display”参数对象

Number *	Name	Object Function	Description	Group Address	Length	C	R	W	T	U	Data Type	Priority
483	KNX Channel 1-...	Device online, status			1 bit	C	-	W	T	U	switch	Low
487	KNX Channel 1-...	Power value			2 bytes	C	-	W	T	U	power (kW)	Low
488	KNX Channel 1-...	Energy value			4 bytes	C	-	W	T	U	active energy (kWh)	Low

Energy metering(power & energy)

Number *	Name	Object Function	Description	Group Address	Length	C	R	W	T	U	Data Type	Priority
483	KNX Channel 1-...	Device online, status			1 bit	C	-	W	T	U	switch	Low
485	KNX Channel 1-...	Current value			2 bytes	C	-	W	T	U	current (mA)	Low
487	KNX Channel 1-...	Power value			2 bytes	C	-	W	T	U	power (kW)	Low
488	KNX Channel 1-...	Energy value			4 bytes	C	-	W	T	U	active energy (kWh)	Low

Energy metering(power & energy & current)

Number *	Name	Object Function	Description	Group Address	Length	C	R	W	T	U	Data Type	Priority
483	KNX Channel 1-...	Device online, status			1 bit	C	-	W	T	U	switch	Low
485	KNX Channel 1-...	Current value			2 bytes	C	-	W	T	U	current (mA)	Low
486	KNX Channel 1-...	Voltage value			4 bytes	C	-	W	T	U	electric potential (V)	Low
487	KNX Channel 1-...	Power value			2 bytes	C	-	W	T	U	power (kW)	Low
488	KNX Channel 1-...	Energy value			4 bytes	C	-	W	T	U	active energy (kWh)	Low

Energy metering(power & energy & current & voltage)

图 6.10.9 “Energy Metering display”参数对象

编号	名称	对象功能	类型	属性	DPT
485	KNX Channel X-{{...}}	Current value	2byte	C,W,T,U	7.012 current(mA)
<p>该通讯对象用于接收来自总线上的电流值，并更新到屏上显示。</p> <p>报文值：0~65535mA，分辨率 1mA。</p>					
485	KNX Channel X-{{...}}	Current value	2byte	C,W,T,U	9.021 current(mA)
<p>该通讯对象用于接收来自总线上的电流值，并更新到屏上显示。</p> <p>报文值：-670760~670760mA，分辨率 0.1mA。</p>					
485	KNX Channel X-{{...}}	Current value	4byte	C,W,T,U	14.019 electric current(A)
<p>该通讯对象用于接收来自总线上的电流值，并更新到屏上显示。</p> <p>报文值：-99999999.9~99999999.9A，分辨率 0.1A。</p>					
486	KNX Channel X-{{...}}	Voltage value	2byte	C,W,T,U	9.020 voltage(mV)
<p>该通讯对象用于接收来自总线上的电压值，并更新到屏上显示。</p> <p>报文值：-670760mV~670760mV，分辨率 0.1mV。</p>					
486	KNX Channel X-{{...}}	Voltage value	4byte	C,W,T,U	14.027 electric potential(V)
<p>该通讯对象用于接收来自总线上的电压值，并更新到屏上显示。</p> <p>报文值：-99999999.9~99999999.9V，分辨率 0.1V。</p>					

487	KNX	Channel	Power	2byte	C,W,T,U	9.024 power(kW)	
	X-{{...}}		value				
<p>该通讯对象用于接收来自总线上的功率值，并更新到屏上显示。</p> <p>报文值：-670760~670760kW，分辨率 0.1kW。</p>							
487	KNX	Channel	Power	4byte	C,W,T,U	14.056 power(W)	
	X-{{...}}		value				
<p>该通讯对象用于接收来自总线上的功率值，并更新到屏上显示。</p> <p>报文值：-99999999.9~99999999.9W，分辨率 0.1W。</p>							
488	KNX	Channel	Energy	4byte	C,W,T,U	13.010	active
	X-{{...}}		value			energy(Wh)	
<p>该通讯对象用于接收来自总线上的电量值，并更新到屏上显示。</p> <p>报文值：-2147483648~2147483647Wh，分辨率 1Wh。</p>							
488	KNX	Channel	Energy	4byte	C,W,T,U	13.013	active
	X-{{...}}		value			energy(kWh)	
<p>该通讯对象用于接收来自总线上的电量值，并更新到屏上显示。</p> <p>报文值：-2147483648~2147483647kWh，分辨率 1kWh。</p>							

表 10.10.1 “Energy Metering display”参数对象

6.10.10 “Sensor”通讯对象

Number ^	Name	Object Function	Description	Group Address	Length	C	R	W	T	U	Data Type	Priority
483	KNX Channel 1-...	Device online, status			1 bit	C	-	W	T	U	switch	Low
485	KNX Channel 1-...	Temperature value			2 bytes	C	-	W	T	U	temperature (°C)	Low
486	KNX Channel 1-...	Low temperature alarm			1 bit	C	R	-	T	-	alarm	Low
487	KNX Channel 1-...	High temperature alarm			1 bit	C	R	-	T	-	alarm	Low

Temperature sensor

Number ^	Name	Object Function	Description	Group Address	Length	C	R	W	T	U	Data Type	Priority
483	KNX Channel 1-...	Device online, status			1 bit	C	-	W	T	U	switch	Low
485	KNX Channel 1-...	Humidity value			2 bytes	C	-	W	T	U	humidity (%)	Low
486	KNX Channel 1-...	Low humidity alarm			1 bit	C	R	-	T	-	alarm	Low
487	KNX Channel 1-...	High humidity alarm			1 bit	C	R	-	T	-	alarm	Low

Humidity sensor

Number ^	Name	Object Function	Description	Group Address	Length	C	R	W	T	U	Data Type	Priority
483	KNX Channel 1-...	Device online, status			1 bit	C	-	W	T	U	switch	Low
485	KNX Channel 1-...	PM2.5 value			2 bytes	C	-	W	T	U	pulses	Low
486	KNX Channel 1-...	PM2.5 alarm			1 bit	C	R	-	T	-	alarm	Low

PM2.5 sensor

Number ^	Name	Object Function	Description	Group Address	Length	C	R	W	T	U	Data Type	Priority
483	KNX Channel 1-...	Device online, status			1 bit	C	-	W	T	U	switch	Low
485	KNX Channel 1-...	PM10 value			2 bytes	C	-	W	T	U	pulses	Low
486	KNX Channel 1-...	PM10 alarm			1 bit	C	R	-	T	-	alarm	Low

PM10 sensor

Number ^	Name	Object Function	Description	Group Address	Length	C	R	W	T	U	Data Type	Priority
483	KNX Channel 1-...	Device online, status			1 bit	C	-	W	T	U	switch	Low
485	KNX Channel 1-...	VOC value			2 bytes	C	-	W	T	U	pulses	Low
486	KNX Channel 1-...	VOC alarm			1 bit	C	R	-	T	-	alarm	Low

VOC sensor

Number ^	Name	Object Function	Description	Group Address	Length	C	R	W	T	U	Data Type	Priority
483	KNX Channel 1-...	Device online, status			1 bit	C	-	W	T	U	switch	Low
485	KNX Channel 1-...	AQI value			2 bytes	C	-	W	T	U	pulses	Low
486	KNX Channel 1-...	AQI alarm			1 bit	C	R	-	T	-	alarm	Low

AQI sensor

Number ^	Name	Object Function	Description	Group Address	Length	C	R	W	T	U	Data Type	Priority
483	KNX Channel 1-...	Device online, status			1 bit	C	-	W	T	U	switch	Low
485	KNX Channel 1-...	CO2 value			2 bytes	C	-	W	T	U	parts/million (ppm)	Low
486	KNX Channel 1-...	CO2 alarm			1 bit	C	R	-	T	-	alarm	Low

CO2 sensor

Number ^	Name	Object Function	Description	Group Address	Length	C	R	W	T	U	Data Type	Priority
483	KNX Channel 1-...	Device online, status			1 bit	C	-	W	T	U	switch	Low
485	KNX Channel 1-...	Brightness value(lux)			2 bytes	C	-	W	T	U	lux (Lux)	Low

Brightness sensor

Number ^	Name	Object Function	Description	Group Address	Length	C	R	W	T	U	Data Type	Priority
483	KNX Channel 1-...	Device online, status			1 bit	C	-	W	T	U	switch	Low
485	KNX Channel 1-...	Wind speed			2 bytes	C	-	W	T	U	speed (m/s)	Low
486	KNX Channel 1-...	Wind alarm			1 bit	C	R	-	T	-	alarm	Low

Wind sensor

Number ^	Name	Object Function	Description	Group Address	Length	C	R	W	T	U	Data Type	Priority
483	KNX Channel 1-...	Device online, status			1 bit	C	-	W	T	U	switch	Low
485	KNX Channel 1-...	I/O signal			1 bit	C	-	W	T	U	switch	Low

I/O sensor

图 6.10.10 “Sensor”通讯对象

编号	名称	对象功能	类型	属性	DPT
485	KNX Channel X-{{...}}	Temperature value	2byte	C,W,T,U	9.001 temperature
485	KNX Channel X-{{...}}	Humidity value	2byte	C,W,T,U	9.007 humidity
485	KNX Channel X-{{...}}	PM2.5 value	2byte	C,W,T,U	7.001 pulse 9.030 concentration(ug/m3)
485	KNX Channel X-{{...}}	PM10 value	2byte	C,W,T,U	7.001 pulse 9.030 concentration(ug/m3)
485	KNX Channel X-{{...}}	VOC value	2byte	C,W,T,U	7.001 pulse 9.030 concentration(ug/m3)
485	KNX Channel X-{{...}}	AQI value	2byte	C,W,T,U	7.001 pulses
485	KNX Channel X-{{...}}	CO2 value	2byte	C,W,T,U	7.001 pulse 9.008 parts/million(ppm)
485	KNX Channel X-{{...}}	Brightness value(lux)	2byte	C,W,T,U	7.013 brightness(lux) 9.004 lux(lux)
485	KNX Channel X-{{...}}	Wind speed	2byte	C,W,T,U	9.005 speed 9.028 wind speed

485	KNX Channel X-{{...}}	I/O signal	1bit	C,W,T,U	1.001 switch
<p>这些通讯对象用于接收来自总线上的空气质量信息，获取相应的值并更新到屏保上显示。屏保上可显示设置为温度、湿度、PM2.5、PM10、VOC、AQI、CO2、光照度、风速和输入输出信号值。</p> <p>对象的数据类型由参数设定。重启时所有对象往总线上发送读请求。</p>					
486	KNX Channel X-{{...}}	Low temperature alarm	1bit	C,R,T	1.005 alarm
<p>该通讯对象用于当温度低于低阈值时，阈值由参数定义，低温警报对象发送警报信号到总线上。</p> <p>报文值：</p> <p style="padding-left: 40px;">1——低温警报</p> <p style="padding-left: 40px;">0——无警报</p>					
487	KNX Channel X-{{...}}	High temperature alarm	1bit	C,R,T	1.005 alarm
<p>该通讯对象用于当温度高于高阈值时，阈值由参数定义，高温警报对象发送警报信号到总线上。</p> <p>报文值：</p> <p style="padding-left: 40px;">1——高温警报</p> <p style="padding-left: 40px;">0——无警报</p>					
486	KNX Channel X-{{...}}	Low humidity alarm	1bit	C,R,T	1.005 alarm
<p>该通讯对象用于当湿度低于低阈值时，阈值由参数定义，低湿度警报对象发送警报信号到总线上。</p>					

报文值:

1——低湿警报

0——无警报

487	KNX Channel X-{{...}}	High humidity alarm	1bit	C,R,T	1.005 alarm
<p>该通讯对象用于当湿度低于高阈值时，阈值由参数定义，高湿度警报对象发送警报信号到总线上。</p> <p>报文值:</p> <p>1——高湿警报</p> <p>0——无警报</p>					
486	KNX Channel X-{{...}}	PM2.5 alarm	1bit	C,R,T	1.005 alarm
486	KNX Channel X-{{...}}	PM10 alarm	1bit	C,R,T	1.005 alarm
486	KNX Channel X-{{...}}	AQI alarm	1bit	C,R,T	1.005 alarm
486	KNX Channel X-{{...}}	CO2 alarm	1bit	C,R,T	1.005 alarm
486	KNX Channel X-{{...}}	VOC alarm	1bit	C,R,T	1.005 alarm
486	KNX Channel X-{{...}}	Wind alarm	1bit	C,R,T	1.005 alarm
<p>这些通讯对象用于 PM2.5/PM10/AQI/CO2/VOC/Wind 超出警报值时，</p>					

PM2.5/PM10/AQI/CO2/VOC/Wind 警报对象发送警报信号到总线上。

报文值：

1——警报

0——无警报

表 6.10.10 “Sensor”通讯对象

6.10.11 “Value sender”通讯对象

Number ^	Name	Object Function	Description	Group Address	Length	C	R	W	T	U	Data Type	Priority
484	KNX Channel 1-...	Locking object			1 bit	C	-	W	-	-	enable	Low
485	KNX Channel 1-...	Send 1bit value			1 bit	C	-	W	T	-	switch	Low
487	KNX Channel 1-...	Send 1bit value, long			1 bit	C	-	W	T	-	switch	Low

1bit value[ON/OFF]

Number ^	Name	Object Function	Description	Group Address	Length	C	R	W	T	U	Data Type	Priority
484	KNX Channel 1-...	Locking object			1 bit	C	-	W	-	-	enable	Low
485	KNX Channel 1-...	Send 2bit value			2 bit	C	-	W	T	-	switch control	Low
487	KNX Channel 1-...	Send 2bit value, long			2 bit	C	-	W	T	-	switch control	Low

2bit value[0...3]

Number ^	Name	Object Function	Description	Group Address	Length	C	R	W	T	U	Data Type	Priority
484	KNX Channel 1-...	Locking object			1 bit	C	-	W	-	-	enable	Low
485	KNX Channel 1-...	Send 4bit value			4 bit	C	-	W	T	-	dimming control	Low
487	KNX Channel 1-...	Send 4bit value, long			4 bit	C	-	W	T	-	dimming control	Low

4bit value[0...15]

Number ^	Name	Object Function	Description	Group Address	Length	C	R	W	T	U	Data Type	Priority
484	KNX Channel 1-...	Locking object			1 bit	C	-	W	-	-	enable	Low
485	KNX Channel 1-...	Send 1byte value			1 byte	C	-	W	T	-	counter pulses (0..255)	Low
487	KNX Channel 1-...	Send 1byte value, long			1 byte	C	-	W	T	-	counter pulses (0..255)	Low

1byte value[0...255]

Number ^	Name	Object Function	Description	Group Address	Length	C	R	W	T	U	Data Type	Priority
484	KNX Channel 1-...	Locking object			1 bit	C	-	W	-	-	enable	Low
485	KNX Channel 1-...	Send 2byte value			2 bytes	C	-	W	T	-	pulses	Low
487	KNX Channel 1-...	Send 2byte value, long			2 bytes	C	-	W	T	-	pulses	Low

2byte value[0...65535]

Number ^	Name	Object Function	Description	Group Address	Length	C	R	W	T	U	Data Type	Priority
484	KNX Channel 1-...	Locking object			1 bit	C	-	W	-	-	enable	Low
485	KNX Channel 1-...	Send 2byte float value			2 bytes	C	-	W	T	-	2-byte float value	Low
487	KNX Channel 1-...	Send 2byte float value, long			2 bytes	C	-	W	T	-	2-byte float value	Low

2byte float value

Number ^	Name	Object Function	Description	Group Address	Length	C	R	W	T	U	Data Type	Priority
484	KNX Channel 1-...	Locking object			1 bit	C	-	W	-	-	enable	Low
485	KNX Channel 1-...	Send 4byte value			4 bytes	C	-	W	T	-	counter pulses (unsign...	Low
487	KNX Channel 1-...	Send 4byte value, long			4 bytes	C	-	W	T	-	counter pulses (unsign...	Low

4byte value[0...4294967295]

Number ^	Name	Object Function	Description	Group Address	Length	C	R	W	T	U	Data Type	Priority
484	KNX Channel 1-...	Locking object			1 bit	C	-	W	-	-	enable	Low
485	KNX Channel 1-...	Send 4byte float value			4 bytes	C	-	W	T	-	4-byte float value	Low
487	KNX Channel 1-...	Send 4byte float value, long			4 bytes	C	-	W	T	-	4-byte float value	Low

4byte float value

图 6.10.11 “Value sender”

编号	名称	对象功能	类型	属性	DPT
485	KNX Channel X-{{...}}	Send 1bit value	1bit	C,T,W	1.001 switch
485	KNX Channel X-{{...}}	Send 2bit value	2bit	C,T,W	2.001 switch control
485	KNX Channel X-{{...}}	Send 4bit value	4bit	C,T,W	3.007 dimming
485	KNX Channel X-{{...}}	Send 1byte value	1byte	C,T,W	5.010 counter pulses
485	KNX Channel X-{{...}}	Send 2byte value	2byte	C,T,W	7.001 pulses
485	KNX Channel X-{{...}}	Send 2byte float value	2byte	C,T,W	9.x float value
485	KNX Channel X-{{...}}	Send 4byte value	4byte	C,T,W	12.001 counter pulses
485	KNX Channel X-{{...}}	Send 4byte float value	4byte	C,T,W	14.x float value

	X-{{...}}		e	W	
<p>这些通讯对象用于发送参数预设的输出值, 如果区分长按和短按操作时, 仅发送短按操作时的输出值。</p> <p>对象类型和数值范围由参数设置的数据类型决定。</p>					
487	KNX Channel X-{{...}}	Send 1bit value, long	1bit	C,T, W	1.001 switch
487	KNX Channel X-{{...}}	Send 2bit value, long	2bit	C,T, W	2.001 switch control
487	KNX Channel X-{{...}}	Send 4bit value, long	4bit	C,T, W	3.007 dimming
487	KNX Channel X-{{...}}	Send 1byte value, long	1byte e	C,T, W	5.010 counter pulses
487	KNX Channel X-{{...}}	Send 2byte value, long	2byte e	C,T, W	7.001 pulses
487	KNX Channel X-{{...}}	Send 2byte float value, long	2byte e	C,T, W	9.x float value
487	KNX Channel X-{{...}}	Send 4byte value, long	4byte e	C,T, W	12.001 counter pulses
487	KNX Channel X-{{...}}	Send 4byte float value, long	4byte e	C,T, W	14.x float value
<p>该通讯对象在区分长按和短按操作时可见, 用于发送长按操作时的输出值。</p>					

表 6.10.11 "Value sender"

6.11 "KNX Scene"通讯对象

Number	Name	Object Function	Linked with	Other Linked	Length	C	R	W	T	U	Data Type	Priority
4923	Scene 1-...	Scene			1 byte	C	-	W	T	-	scene con...	Low

图 6.11 “KNX Scene”通讯对象

编号	名称	对象功能	类型	属性	DPT
4923/.../4	Scene	Scene	1byte	C,T,W	18.001 scene control
952	X-{{...}}	control	e		

场景功能使能时，该通讯对象时可见。用于通过总线调用/保存场景。

表 6.11 “KNX Scene”通讯对象

6.12 “Input x”通讯对象

4953	Input 1 - ...	Disable			1 bit	C	-	W	-	-	enable	Low
------	---------------	---------	--	--	-------	---	---	---	---	---	--------	-----

图 6.12 “Input x”通讯对象

编号	名称	对象功能	类型	属性	DPT
4953	Input X-{{...}}	Disable	1bit	C,W	1.003 enable

功能禁止/使能 Input 功能

表 6.12 “Input x”通讯对象

6.12.1 “Switch”通讯对象

Number	Name	Object Function	Linked with	Other Linked	Length	C	R	W	T	U	Data Type	Priority
4954	Input 1 - ...	Switch			1 bit	C	-	W	T	U	switch	Low
4954	Input 1 - ...	Close, Switch			1 bit	C	-	W	T	U	switch	Low
4955	Input 1 - ...	Open, Switch			1 bit	C	-	W	T	U	switch	Low

图 6.12.1 “Switch”通讯对象

编号	名称	对象功能	类型	属性	DPT
4954	Input X-{{...}}	Switch	1bit	C,W,T ,U	1.001 switch
4954	Input X-{{...}}	Close, Switch	1bit	C,W,T ,U	1.001 switch
4954	Input X-{{...}}	Short, Switch	1bit	C,W,T ,U	1.001 switch
4955	Input X-{{...}}	Open, Switch	1bit	C,W,T ,U	1.001 switch
4955	Input X-{{...}}	Long, Switch	1bit	C,W,T ,U	1.001 switch

one object 选项或长操作/释放操作 no action 时显示。

two object 选项, 区分长短操作时, 显示 short../long...; 不区分时显示 close.../open...

表 6.12.1 “Switch”通讯对象

6.12.2 “Actual temperature, Sensor”通讯对象

Number	Name	Object Function	Linked with	Other Linked	Length	C	R	W	T	U	Data Type	Priority
4954	Input 1 - ...	Actual temperature, Sensor			2 bytes	C	R	-	T	-	temperature (°C)	Low

图 6.12.2 “Actual temperature, Sensor”通讯对象

编号	名称	对象功能	类型	属性	DPT
----	----	------	----	----	-----

4954	Input X-{{...}}	Actual temperature, Sensor	2byte	Actual temperature, Sensor	9.001 temperature
4955	Input X-{{...}}	Temperature error report, Sensor	1bit	C,R,T	1.005 alarm

one object 选项或长操作/释放操作 no action 时显示。

选择选项 External NTC sensor 时可见

表 6.12.2 “Actual temperature, Sensor”通讯对象

6.12.3 “Scene”通讯对象

Number	Name ▾	Object Function	Linked with	Other Linked	Length	C	R	W	T	U	Data Type	Priority
4954	Input 1 - ...	Scene			1 byte	C	-	-	T	-	scene control	Low
4954	Input 1 - ...	Close, Scene			1 byte	C	-	-	T	-	scene control	Low
4955	Input 1 - ...	Open, Scene			1 byte	C	-	-	T	-	scene control	Low

图 6.12.3 “Scene”通讯对象

编号	名称	对象功能	类型	属性	DPT
4954	Input X-{{...}}	Scene	1byte	C,T	18.001 scene control
4954	Input	Close,	1byte	C,T	18.001 scene control

	X-{{...}}	Scene	e		
4954	Input X-{{...}}	Short, Scene	1byt e	C,T	18.001 scene control
4955	Input X-{{...}}	Open, Scene	1byt e	C,T	18.001 scene control
4955	Input X-{{...}}	Long, Scene	1byt e	C,T	18.001 scene control
<p>one object 选项或长操作/释放操作 no action 时显示。</p> <p>two object 选项, 区分长短操作时, 显示 short../long...; 不区分时显示 close../open...</p>					

表 6.12.3 “Scene”通讯对象

6.12.4 “String”通讯对象

Number	Name	Object Function	Linked with	Other Linked	Length	C	R	W	T	U	Data Type	Priority
4954	Input 1 - ...	String			14 bytes	C	-	-	T	-	Character Strin...	Low

图 6.12.4 “String”通讯对象

编号	名称	对象功能	类型	属性	DPT
4954	Input X-{{...}}	String	14by te	C,T	16.001 character string (ISO 8859-1)
4954	Input X-{{...}}	Close, String	14by te	C,T	16.001 character string (ISO 8859-1)
4954	Input X-{{...}}	Short, String	14by te	C,T	16.001 character string (ISO 8859-1)
4955	Input	Open,	14by	C,T	16.001 character string

	X-{{...}}	String	te		(ISO 8859-1)
4955	Input X-{{...}}	Long, String	14by te	C,T	16.001 character string (ISO 8859-1)
<p>one object 选项或长操作/释放操作 no action 时显示。</p> <p>two object 选项, 区分长短操作时, 显示 short../long...; 不区分时显示 close.../open...</p>					

表 6.12.4 “String”通讯对象

6.12.5 “Security area status”通讯对象

Number	Name	Object Function	Linked with	Other Linked	Length	C	R	W	T	U	Data Type	Priority
4954	Input 1 - ...	Security area status			1 byte	C	-	-	T	-	counter pulses (...Low	

图 6.12.5 “Security area status”通讯对象

编号	名称	对象功能	类型	属性	DPT
4954	Input X-{{...}}	Security area status	1byt e	C,R,T	5.010 counter pulses
<p>发送标准防区下断线报警、正常状态、触发状态下的值</p>					

表 6.12.5 “Security area status”通讯对象

6.13 “Extension function”通讯对象

4977	Extension function	Screen locking	1 bit	C - W - - enable	Low
4978	Extension function	Screen on/off	1 bit	C - W - - switch	Low
4979	Extension function	Wake-up screen trigger,1bit value	1 bit	C - - T - switch	Low
4982	Extension function	Night mode	1 bit	C R - T - day/night	Low
4983	Extension function	Summer time status	1 bit	C - - T - enable	Low
4984	Extension function	Dis/En Proximity function	1 bit	C - W - - enable	Low
4985	Extension function	Proximity input	1 bit	C - W - - switch	Low
4986	Extension function	Proximity output	1 bit	C - - T - switch	Low

图 6.13 “Extension function, Screensaver”通讯对象

编号	名称	对象功能	类型	属性	DPT
4977	Extension function	Screen locking	1bit	C,W	1.003 enable
<p>该通讯对象用于锁屏，锁屏后将不能对整个屏幕界面进行任何操作，但仍可接收总线报文。报文值：</p> <p>1 —— 解锁</p> <p>0 —— 锁屏</p>					
4978	Extension function	Screen on/off	1bit	C,W	1.001 switch
<p>该通讯对象用于控制亮屏/灭屏。</p> <p>报文值：</p> <p>1 —— 亮屏</p> <p>0 —— 灭屏</p>					
4979	Extension function	Wake-up screen trigger,1bit value/1byte value/scene NO.	1bit 1byte	C,T	1.001 switch 5.010 counter pulses 5.001 percentage

					17.001 scene number
<p>该通讯对象在使能唤醒密码功能，且选择输出值时可见。对象可分别向总线发送报文，值的范围由选择的数据类型决定。</p>					
498 2	Extension function	Night mode	1bit	C,R, T C,W, T,U	1.024 day/night
<p>该通讯对象用于往总线上发送白天/夜晚状态，报文值由参数定义。</p> <p>白天/夜晚状态根据对象切换时，可通过总线接收报文值切换，对象属性为 C,W,T,U；</p> <p>当根据时间点或日出日落切换时，不可通过总线切换，对象属性为 C,R,T。</p>					
498 3	Extension function	Summer time status	1bit	C,T	1.003 enable
<p>该通讯对象用于通过总线发送夏令时的状态报文。报文值：</p> <p>1 —— 处于夏令时的状态中</p> <p>0 —— 处于非夏令时的状态中</p>					
498 4	Extension function	Dis/En Proximity function	1bit	C,W	1.003 enable
<p>该通讯对象用于使能/禁止靠近感应功能。</p>					
498 5	Extension function	Proximity input	1bit	C,W	1.001 switch
<p>当靠近感应功能通过对象触发时，该通讯对象可见。接收总线上的报文值：</p> <p>1——用于触发靠近感应</p>					

0——用于离开（无靠近）					
498	Extension	Proximity output	1bit	C,T	1.001 switch
6	function		1byte		5.010 counter pulses
					17.001 scene number
					5.001 percentage
<p>该通讯对象由参数“Object type of output value”决定，当检测到人体靠近感应区域时，对象可分别向总线发送参数指定值（1byte）或 ON(1bit)到总线上。值的范围由选择的数据类型决定。</p>					

表 6.13 “Extension function, Screensaver”通讯对象