

User manual

K-BUS S series

KNX Push Button Sensor with Display, 1/2/3-gang_V1.5

CHPBD-02/12.x.1y

CHPBD-04/24.x.1y

CHPBD-06/36.x.1y

(x=1: Normal glass; x=2: Mirror glass)

(y=0: White; y=1: Black)



KNX/EIB Home and Building Control System

Attentions

1. Please keep devices away from strong magnetic field, high temperature, wet environment;

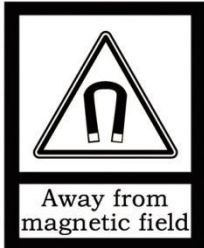

2. Do not fall the device to the ground or make them get hard impact;



3. Do not use wet cloth or volatile reagent to wipe the device;



4. Do not disassemble the devices.

Contents

Chapter 1 Summary	1
Chapter 2 Technical Data	2
Chapter 3 Dimension and Structural Diagram	3
3.2.Dimension Diagram	3
3.3.Structural Diagram	4
Chapter 4 Project Design and Programming	6
Chapter 5 Parameter setting description in the ETS	8
5.1. KNX Secure	8
5.2.Parameter window "General"	12
5.2.1.Parameter window "General setting"	12
5.2.2.Parameter window "Proximity setting"	20
5.2.3.Parameter window "Advanced setting"	21
5.3.Parameter window "Internal temperature measurement"	22
5.4.Parameter window "Button"	25
5.4.1.Switch	28
5.4.2.Dimming	31
5.4.3.RGB switching/send value	33
5.4.4.RGBW switching/send value	34
5.4.5.Colour temperature switching/send value	36
5.4.6.Value sender	37
5.4.7.Scene control	38
5.4.8.Blind	40
5.4.9.Shift register	41
5.4.10.Multiple operation	44
5.4.11.Delay mode	46
5.4.12.LED indication	47
5.4.13.Parameter window "Customized colour"	52
5.5.Parameter window "Logic"	53
5.5.1.Parameter window "AND/OR/XOR"	54
5.5.2.Parameter window "Gate forwarding"	57
5.5.3.Parameter window "Threshold comparator"	58
5.5.4.Parameter window "Format convert"	61
5.5.5.Parameter window "Gate function"	62
5.5.6.Parameter window "Delay function"	63
5.5.7.Parameter window "Staircase lighting"	64
5.6.Parameter window "Scene Group"	66
Chapter 6 Description of Communication Object	69
6.1."General" Communication Object	69

6.2. "Internal sensor" Communication Object	71
6.3. "Button" Communication Object	72
6.4. "Logic" Communication Object	80
6.4.1. "AND/OR/XOR" Communication Object	80
6.4.2. "Gate forwarding" Communication Object	80
6.4.3. "Threshold comparator" Communication Object	81
6.4.4. "Format convert" Communication Object	82
6.4.5. "Gate function" Communication Object	84
6.4.6. "Delay function" Communication Object	85
6.4.7. "Staircase lighting" Communication Object	86
6.5. "Scene Group" Communication Object	87
Chapter 7 Icon list	88
7.1. Device icon	88
7.2. Scene icon	91

Chapter 1 Summary

KNX Push Button Sensor with Display,1/2/3-gang integrates the basic control functions of Switch, Dimming, RGB/RGBW lighting, Colour temperature control, Blind, Scene, Value sender, Shift register, Multiple operation, Delay mode, and has a built-in temperature sensor to detect the local ambient temperature and supports RGB indication function.

In addition, the series products support Logic function and Scene Group function, provide more possibilities for special and complex applications.

KNX Push Button Sensor with Display,1/2/3-gang is powered from KNX bus. It is available to assign the physical address and configure the parameters by engineering design tools ETS with .knxprod (support edition ETS5.7 or higher).

The functions are summarized as followed:

- 1/2-gang: 0.96 inch colour LCD, display area resolution 160x80
- 3-gang: 0.85 inch colour LCD, display area resolution 128x80
- Support vertical or horizontal display via ETS
- Switch and Dimming
- Blind control
- Value sender
- Scene control
- Shift register
- RGB , RGBW and colour temperature control
- Multiple operation
- Delay mode
- Built-in temperature sensor
- Logic output, Scene group conversion
- RGB LED indication function
- Support the KNX Data Secure

Chapter 2 Technical Data

Power Supply	Bus voltage	21-30V DC, via the KNX bus
	Bus current	<15mA/24V; <13mA/30V (1-gang)
		<20mA/24V; <15mA/30V (2-gang)
		<26mA/24V; <20mA/30V (3-gang)
	Bus consumption	<0.4W (1-gang)
		<0.48W (2-gang)
<0.63W (3-gang)		
Connection	KNX	Bus connection terminal(Red/Black)
Operation and display	Programming LED and button	For assigning the physical address
Temperature	Operation	-5 °C ... 45 °C
	Storage	-25 °C ... 55 °C
	Transport	-25 °C ... 70 °C
Environment	Humidity	<93%, except dewing
Dimension	86 × 86 × 35.6mm	
Weight	0.17kg	
Mounting	European 80 type wall-mounted box or 86 type wall-mounted box	

Chapter 3 Dimension and Structural Diagram

3.2. Dimension Diagram

KNX Push Button Sensor with Display, 1/2/3-gang are the same size, and only take 3-gang as example:

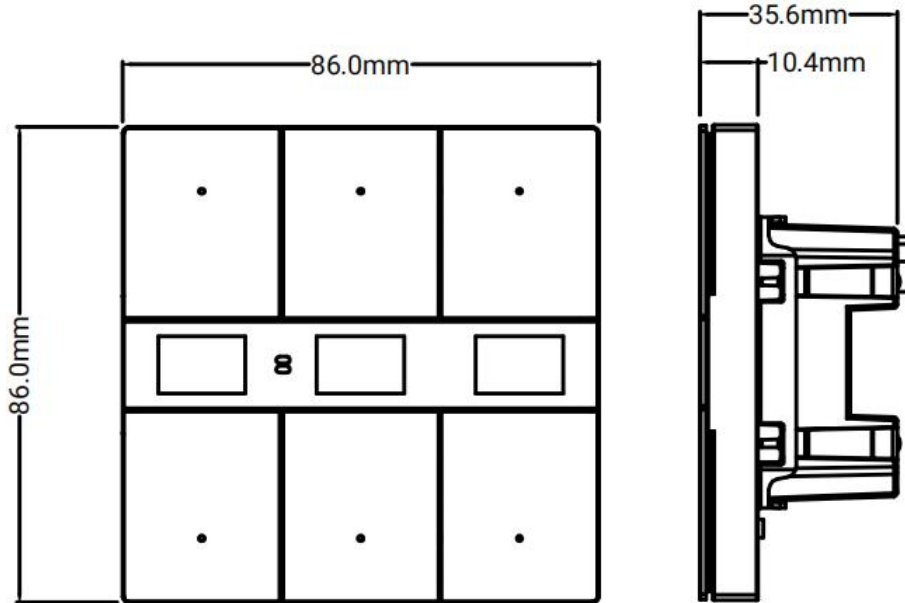

Panel dimension

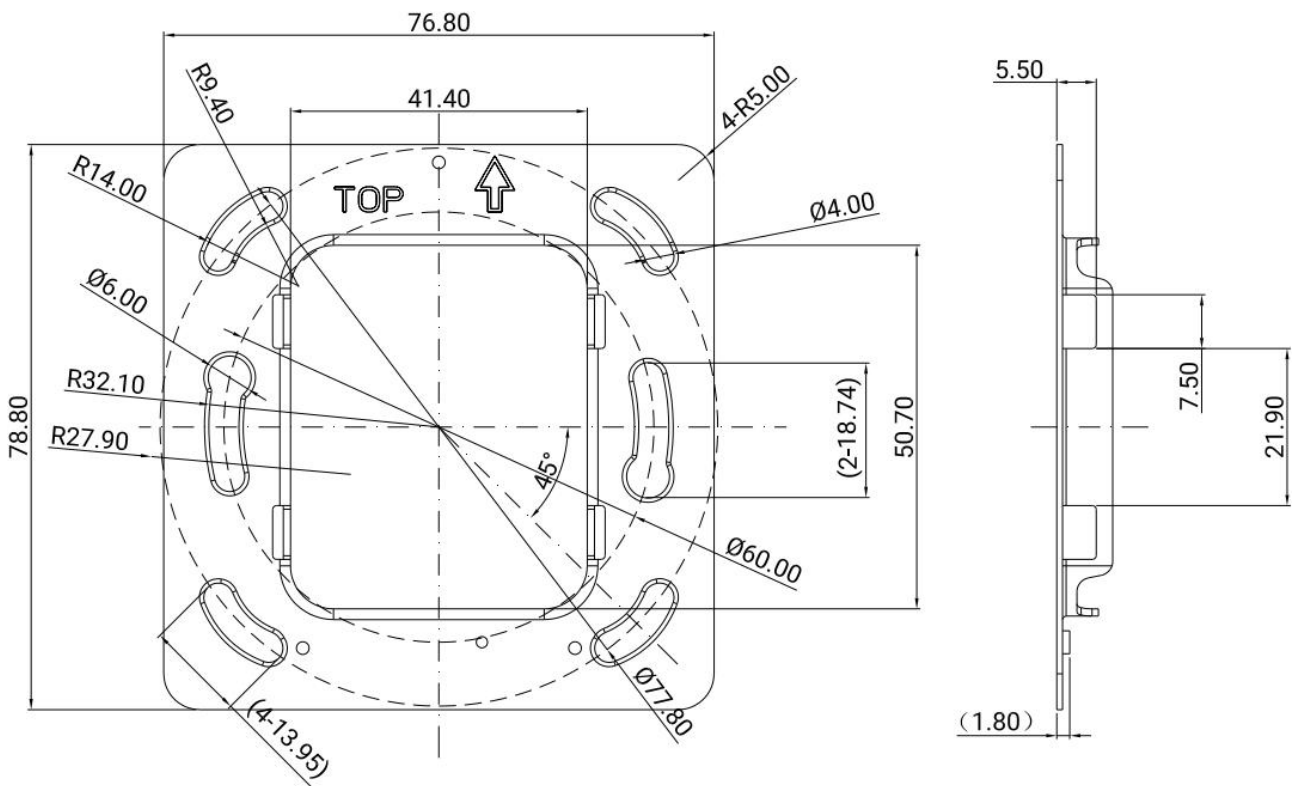

Metal plate dimension

3.3. Structural Diagram

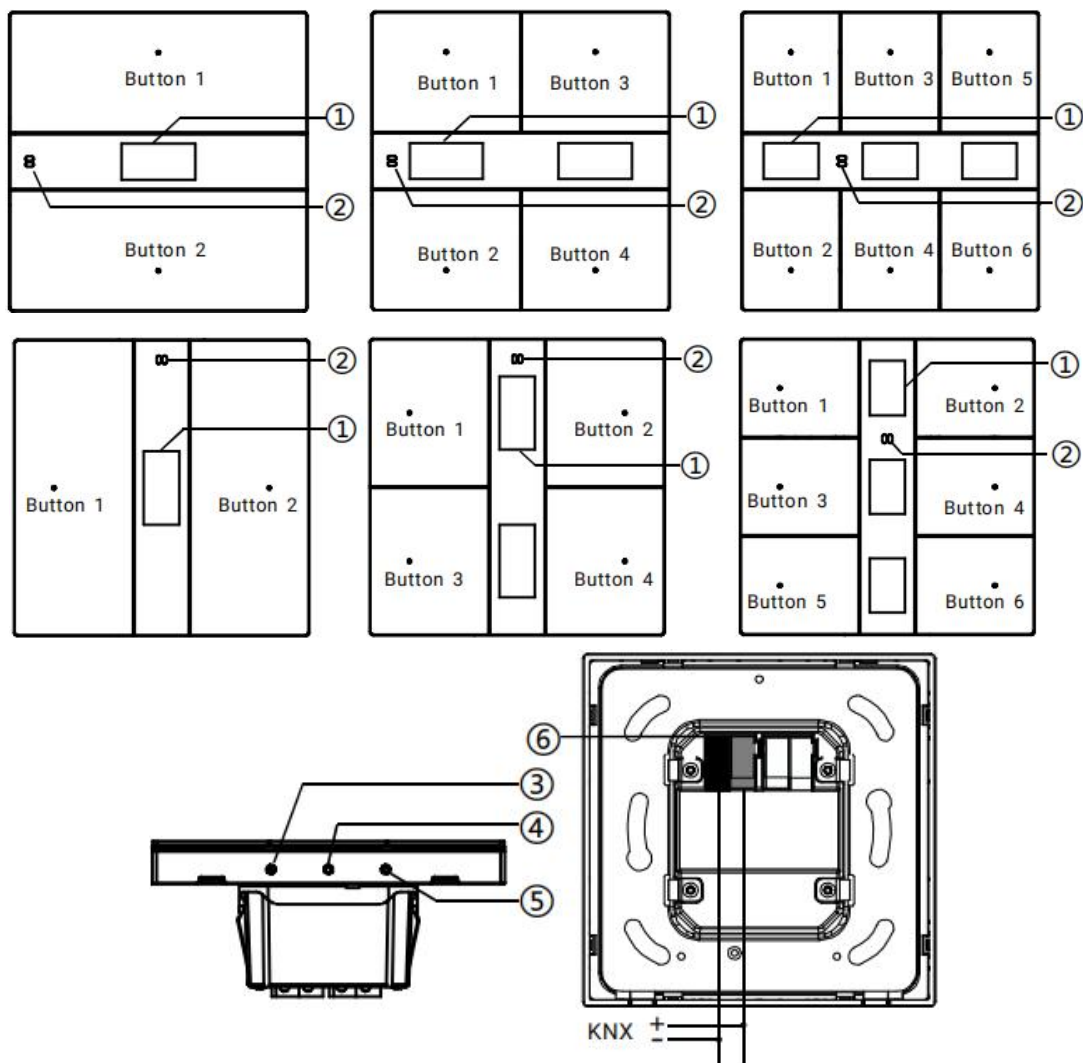

- ① Display area
- ② Proximity sensor
- ③ Programming LED
- ④ Programming button
- ⑤ Internal temperature sensor
- ⑥ KNX bus connection terminal

Reset the device to the factory configuration: press the programming button and hold for 4 seconds then release, repeat the operation for 4 times, and the interval between each operation is less than 3 seconds

Note: In horizontal display mode, the screw holes of the wall-mounted box are fixed in the left and right, as shown in Fig.1; while in vertical display mode, rotate the product clockwise by 90° during installation, and the screw holes of the wall-mounted box must be fixed in the up and bottom, as shown in Fig.2.

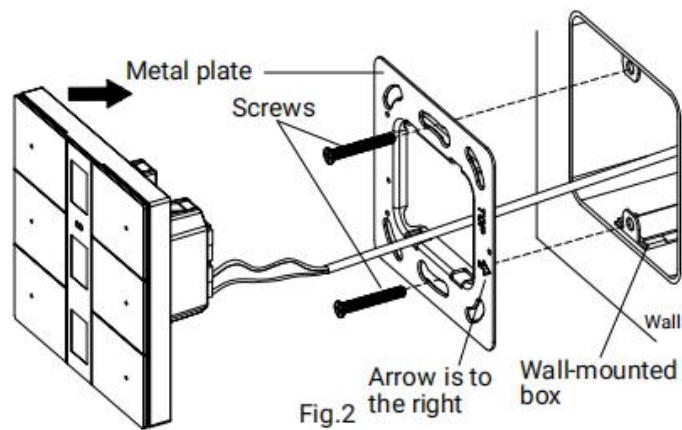
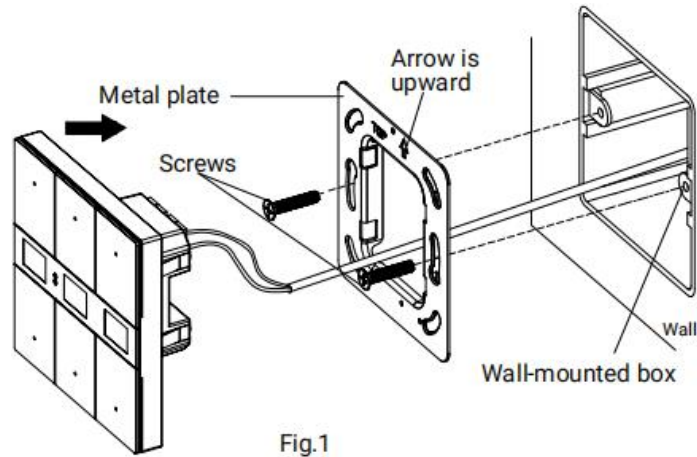

Chapter 4 Project Design and Programming

Application	Maximum of communication objects	Maximum number of group addresses	Maximum number of associations	Secure group addresses
Button/Display/1.2	189	300	300	300

General function

General function includes device In operation setting, KNX telegrams delay time setting, request device status after voltage recovery. And support whether to enable normal/night mode.

Temperature measurement function

Support internal temperature measurement, and can be sent to the bus after change or cyclically;
Support high or low temperature alarm, and can be sent to the bus.

Button function

Each button can be configured as independent function, and can activate disable function. Support the functions, including switch, dimming, blind, scene, value sender, shift register, multiple operation, delay mode.

For switch and scene functions, it is possible to configure whether long and short operation to select common 1 object or separate 2 objects.

Indication LED function

Brightness level of indication LED is adjustable, and adjusted according to normal/night status. And set the delay time for entering standby mode and for LED status all turned off.

When the delay time is not 0, enable/disable panel orientation indication function, support to set the work mode, colour, indication period time and brightness.

The indication settings for button functions:

①Disable, Control by button switch object, Control by external object (1bit/1byte), Indicate button press (Flash and Always on), Always on.

②The LED indication colours can be set independently. When customized colours are used, Customized colour configuration is required.

Logic function

Up to support 8 channels of logic, each channel up to support 8 inputs and 1 logic result.

Logic function support functions, including AND, OR, XOR, Gate forwarding, Threshold comparator, Format convert, Gate function, Delay function and Staircase lighting.

Scene group function

Up to support 8 channels of scene group forward, each group up to support 8 configurable output, datatype is optional 1bit/1byte/2byte.

Chapter 5 Parameter setting description in the ETS

5.1. KNX Secure

KNX Push Button Sensor with Display,1/2/3-gang are KNX devices those comply with the KNX secure standard. That is, you can run the device in safe way.



Fig.5.1 (1) "KNX Secure" parameter window

The device with KNX secure will be displayed notes on ETS, as shown as Fig.5.1(1).

If secure commissioning is activated in ETS project, the following information must be considered during device debugging:



- ❖ It is essential to assign a project password as soon as a KNX Secure device is imported into a project. This will protect the project against unauthorized access.

The password must be kept in a safe place – access to the project is not possible without it (not even the KNX Association or device manufacturer will be able to access it)!

Without the project password, the commissioning key will not be able to be imported.

- ❖ A commissioning key is required when commissioning a KNX Secure device (first download). This key (FDSK = Factory Default Setup Key) is included on a sticker on the side of the device, and it must be imported into the ETS prior to the first download:

- ❖ On the first download of the device, a window pops up in the ETS to prompt the user to enter the key, as shown in Fig.5.1 (2) below.

The certificate can also be read from the device using a QR scanner (recommended).

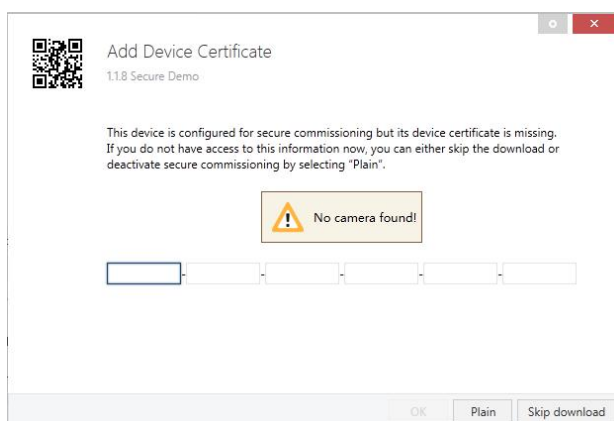

Fig.5.1(2) Add Device Certificate window

✧ Alternatively, the certificates of all Secure devices can be entered in the ETS beforehand.

This is done on the "Security" tab on the project overview page, as shown in Fig.5.1(3) below.

The certificates can be also added to the selected device in the project, as shown in Fig.5.1(4).

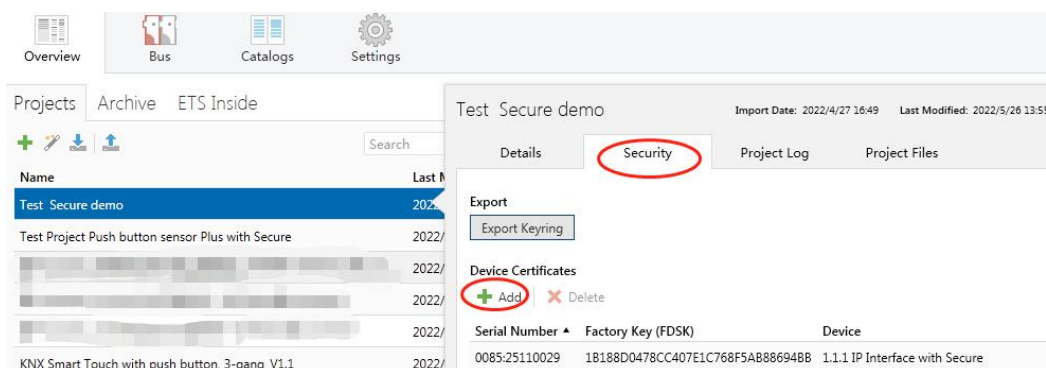

Fig.5.1(3) Add Device Certificate

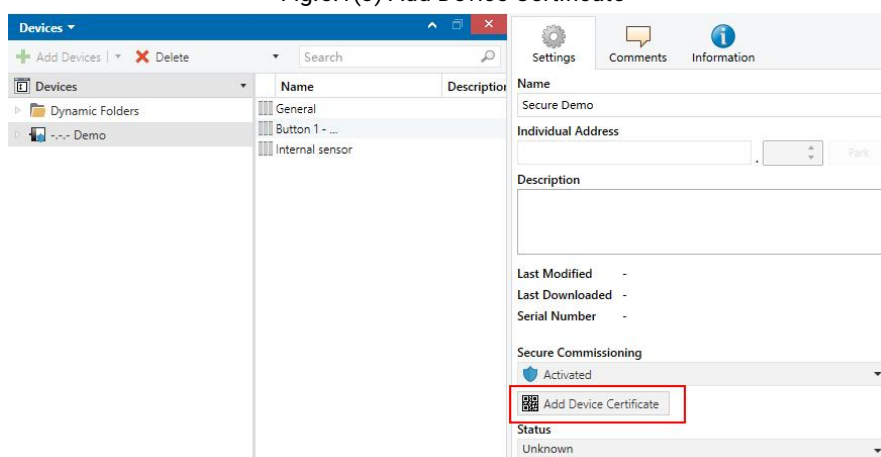

Fig.5.1(4) Add Device Certificate

✧ There is a FDSK sticker on the device, which is used for viewing FDSK number.

Without the FDSK, it will no longer be possible to operate the device in KNX Secure mode after a reset.

The FDSK is required only for initial commissioning. After entering the initial FDSK, the ETS will assign a new key, as shown in Fig.5.1(5) below.

The FDSK will be required again only if the device was reset to its factory settings (e.g. If the device is to be used in a different ETS project).

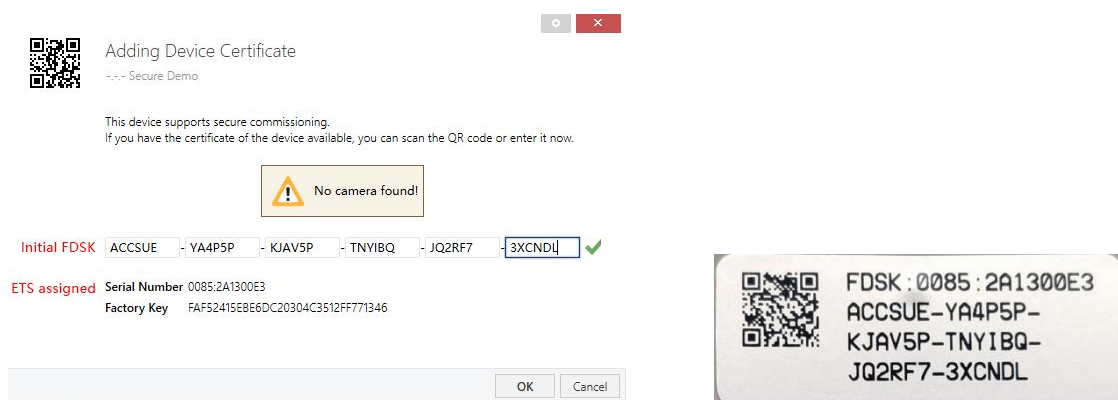

Fig.5.1(5)

Example:

If this application in the project needs to be tried with another device, it is no longer the original device. When the application is downloaded to a new device, the following prompt will appear on the left of Fig.5.1(6), click yes, the Add Device Certificate window will appear, then enter the initial FDSK of the new device, and you need to reset the device to the factory settings (it is not required if the device is still factory default; If it has been used, it will be required to reset, otherwise the following error message will appear on the right of Fig.5.1(6)), and then the device can be successfully downloaded again.

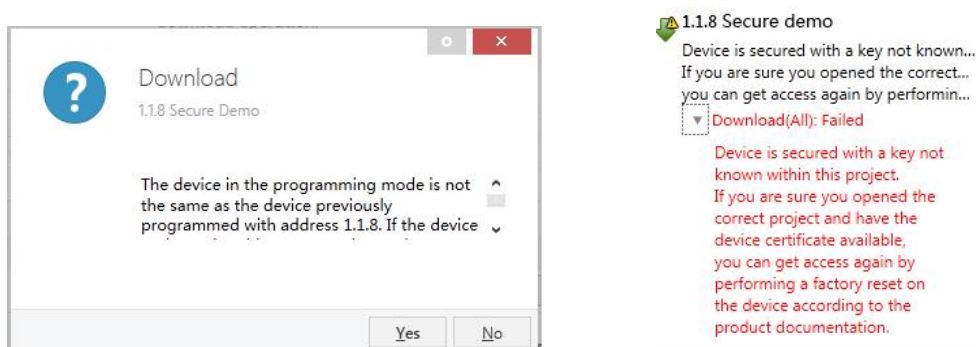

Fig.5.1(6) Example

Whether the device is replaced in the same project, or the device is replaced in a different project, the processing is similar: **Reset the device to the factory settings, then reassign the FDSK.**

After the device is downloaded successfully, the label Add Device Certificate turns gray, indicating that the key for this device has been assigned successfully, as shown in Fig.5.1(7) below.

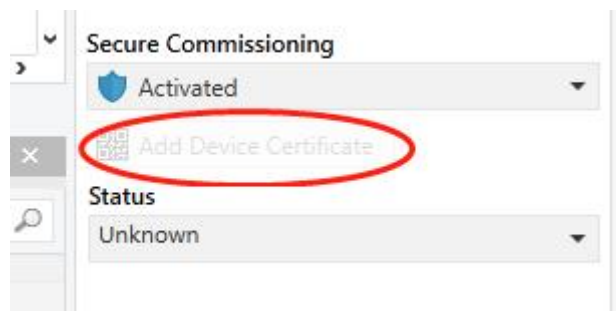

Fig.5.1(7)

ETS generates and manages keys:

Keys and passwords can be exported as needed to the use of security keys outside of the associated ETS projects. As shown in Fig.5.1(8) below, the file extension is .knxkeys.

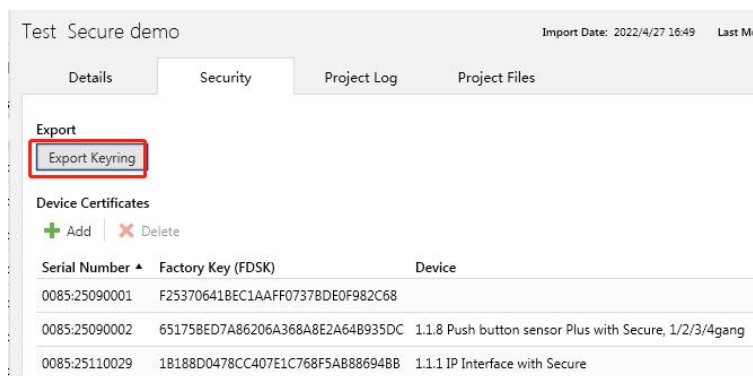

Fig.5.1(8)

Note: Any USB interface used for programming a KNX Secure device must support "long frames".

Otherwise ETS will report a download failure information, as shown below.



Fig.5.1(9)

5.2.Parameter window “General”

5.2.1.Parameter window “General setting”

Send delay after voltage recovery [0..15]	5	s
Send cycle of "In operation" telegram [1..240,0=inactive]	0	s
Extension function		
Night mode	<input checked="" type="checkbox"/>	
Night mode need send read request after voltage recovery	<input checked="" type="checkbox"/>	
<div style="border: 1px solid #ccc; padding: 5px; background-color: #e6f2ff;"> <p>i Note: Default to normal mode if no response when request after startup</p> </div>		
Proximity function	<input type="checkbox"/>	
Screen display setting		
<div style="border: 1px solid #ccc; padding: 5px; background-color: #e6f2ff;"> <p>i Note:The codepage option in the property of project must select the Unicode(UTF-8) 警告：请务必确保工程属性里的编码页选项为UTF-8，否则中文显示将会异常</p> </div>		
Display mode	<input checked="" type="radio"/> Vertical <input type="radio"/> Horizontal	
Font size	<input type="radio"/> Large <input checked="" type="radio"/> Normal	
Brightness setting		
Status LED brightness in normal mode	50	%
Status LED brightness in night mode	5	%
Status LED brightness in standby mode	5	%
Screen brightness in normal mode	80	%
Screen brightness in night mode	30	%
Screen brightness in standby mode	50	%
Delay time after no operation for standby mode [0...255,0=inactive]	10	s
Delay time for turn off all status LED after standby mode [0...255,0=inactive]	10	s
Delay time for turn off Screen after standby mode [0...255,0=inactive]	20	s



Fig.5.1.1 "General setting" parameter window

Parameter "Send delay after voltage recovery [0..15]"

This parameter is for setting the delay time that sends status request telegram to bus after the device voltage recovery. Options: **0..15 s**

The setting dose not contain the device initialization time, and bus telegrams received during delay time will be recorded.

Parameter "Send cycle of "In operation" telegram [1..240,0=inactive]"

This parameter is for setting the time interval when this device cycle send telegrams through the bus to indicate this device in normal operation. When set to "0", the object "In operation" will not send a telegram. If the setting is not "0", the object "In operation" will send a telegram according to the set period time with logic "1" to the bus. Options: **0...240s, 0= inactive**

As to reduce the bus load as much as possible, the maximum time interval should be selected according to actual needs.

Extension function

Parameter "Night mode"

Parameters as follow are visible when the parameter enabled, to set night mode.

Parameter "Night mode need send read request after voltage recovery"

This parameter is for setting whether the object "Night mode" to send read request when bus recovery or finish programming.

If send the read request, LED indicates according to setting brightness of responded normal/night mode.

Note: Default to normal mode if no response when request after startup

This note is visible when previous parameter is enabled.

Parameter "Proximity function"

Setting page of input interface is visible after this parameter enabled.

Note: When disabled, the proximity function is automatically activated by button presses.

Screen display setting

Note:The codepage option in the property of project must select the Unicode(UTF-8)
 警告：请务必确保工程属性里的编码页选项为UTF-8，否则中文显示将会异常

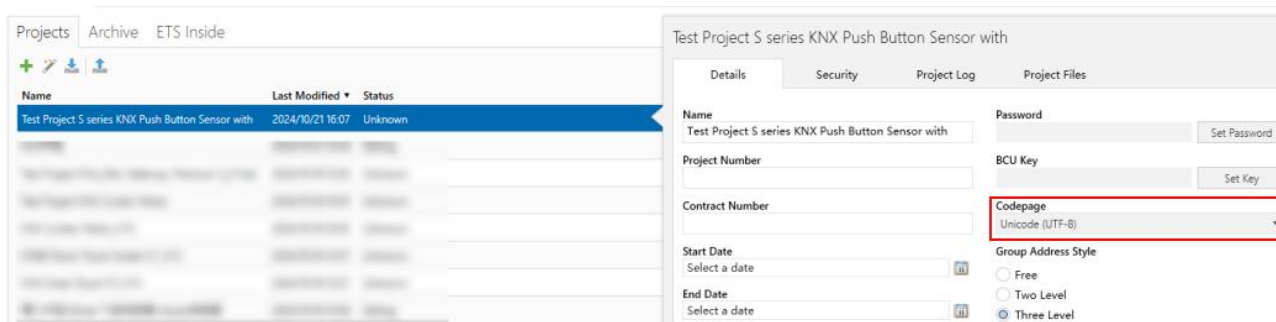

Parameter "Display mode"

This parameter is for setting display mode, according to the installation direction of the device.

Options:

Vertical

Horizontal

Parameter "Font size"

This parameter is for setting the font size for display. Options:

Large

Normal

The custom description is limited in 16 bytes, and the maximum number of characters that can be displayed for each font size is shown in the following tables.

When display mode is Horizontal, only one line of characters can be displayed, the number of words that can be displayed as follows:

Font type	Large (height 3.2mm)				Normal (height 2.4mm)			
	Chinese	Capitalization in English	Lowercase in English	Number	Chinese	Capitalization in English	Lowercase in English	Number
1/2-gang	5	10	11	11	5	12	14	13
3-gang	4	7	7	7	5	8	10	9

When display mode is Vertical, the number of lines that can be displayed and the number of words that can be displayed in each line is as follows:

Font type	Large (height 3.2mm) Up to one line displayed				Normal (height 2.4mm) Word wrap with up to two lines displayed			
	Chinese	Capitalization in English	Lowercase in English	Number	Chinese	Capitalization in English	Lowercase in English	Number
1/2-gang	2	4	5	5	3	5	6	6
3-gang	2	4	5	5	3	5	6	6

Note: the number of characters for display is related to the actual font width, this table is for reference only.

Brightness setting

Parameter "Status LED brightness in normal mode"

This parameter is for setting the button LED brightness when indicated during normal or day mode.

Options:

- 0%
- 5%
- 10%
- 20%
- ...
- 100%

Parameter "Status LED brightness in night mode"

This parameter is visible when night mode enabled. Set the button LED brightness when indicated during night mode. Options:

- 0%
- 5%
- 10%
- 20%
- ...
- 100%

Parameter "Status LED brightness in standby mode"

This parameter is visible when the delay time for the normal mode to enter the standby mode is not 0. Set the button LED brightness when indicated during standby mode. Options:

- 5%
- 10%
- 20%
- ...
- 70%

Parameter "Screen brightness in normal mode"

This parameter is for setting the screen brightness when indicated during normal or day mode. Options:

- 20%
- 30%
- ...
- 100%

Parameter "Screen brightness in night mode"

This parameter is visible when night mode enabled. Set the screen brightness when indicated during night mode. Options:

- 20%
- 30%
- ...
- 100%

Parameter "Screen brightness in standby mode"

This parameter is visible when the delay time for the normal mode to enter the standby mode is not

0. Set the screen brightness when indicated during standby mode. Options:

20%

30%

40%

50%

Parameter "Delay time after no operation for standby mode [0...255,0=inactive]"

This parameter is for setting the delay time for the normal mode to enter the standby mode. When 0, it will not activate standby mode. Options: **0...255 s,0=inactive**

Parameter "Delay time for turn off all status LED after standby mode[0...255,0=inactive]"

Parameter "Delay time for turn off Screen after standby mode[0...255,0=inactive]"

These two parameters are visible when the delay time for the normal mode to enter the standby mode is not 0. Set the delay time for turn off all indication LED and screen after standby mode. When 0, the command to turn off all LED will not be executed. Options: **0...255 s,0=inactive**

Parameter "Delay time for turn off all status LED [0...255,0=inactive]"

Parameter "Delay time for turn off Screen [0...255,0=inactive]"

These two parameters are visible when the delay time for the normal mode to enter the standby mode is 0. Set the delay time for turn off all indication LED and screen after normal mode. When 0, the command to turn off all LED will not be executed. Options: **0...255 s,0=inactive**

When the delay time for turn off screen is set to 0, the following warning is prompted:



Note: It is only recommend that this option is used for demonstration purpose,screen may be damaged when permanent on for long time

Parameter "Screen&LED on/off function"

This parameter is visible when the delay time for turn off screen is 0, or when the delay time for turn off LED and screen are both 0. Control on/off screen via the 1bit object "Screen&LED on/off" when not enable delay time for turn off screen function, and also set whether to control LED on/off status at the same time. When open the LED indication, according to the current status to indicate.

Options:

Only apply to screen

Apply to Both Screen and Status LED

Note: LED on/off status can not be controlled via this function object when only the delay time for turn off LED is 0.

Parameter "Panel orientation indication when turn off status LED"

This parameter is visible when the delay time for the indication LED all to go off is not 0. Set whether to activate panel orientation indication when turn off all LED. Options:

Disable

Always trigger

Trigger via object

Parameters as follow are visible when panel orientation indication function is enabled:

LED x reuse as indication LED(x=2/4/6, display according to push button type)

Parameter "Work mode"

This parameter is visible when panel orientation indication function is enabled and selected "Trigger via object". Set the work mode for panel orientation indication. Options:

0=trigger/1=no trigger

1=trigger/0=no trigger

0 is trigger,1 is no reaction

1 is trigger,0 is no reaction

Parameter "Colour of indication LED"

This parameter is for setting the colour of panel orientation indication LED. Options:

Red	Orange
Green	Cyan blue
Blue	Customized colour 1
White	Customized colour 2
Yellow	Customized colour 3
Cyan	Customized colour 4
Magenta	Customized colour 5

Parameter “Indication period time”

Orientation indication LED lights up is a fading soft flashing effect, with a fixed time of approx. 5s from dark to light and back again. This parameter defines a full cycle, that is including two periods, 5s for the soft flashing effect and always off. The longer the set time is, the longer the time of always off is longer.

Options:

10s

20s

...

60s

Parameter “Brightness of indication LED”

This parameter is for setting the brightness of panel orientation indication LED. Options:

5%

10%

20%

...

50%

5.2.2.Parameter window “Proximity setting”

The Proximity function triggered via	Sensor
Sensor sensitivity	Low
Object type of output value	1bit[On/Off]
Output value	<input type="radio"/> OFF <input checked="" type="radio"/> ON
Delay time for sending [0..65535]	0 s

Fig.5.2.2 “Proximity setting” parameter window

Parameter “The Proximity function triggered via”

This parameter is for setting the trigger way of proximity function. Options:

- Sensor**
- Proximity object**
- Sensor or Proximity object**

When “Sensor or Proximity object” is selected, not send output value when proximity triggered via object.

Parameters as follow are visible when “Sensor” or “Sensor or Proximity object” is selected.

Parameter “Proximity Sensitivity ”

This parameter is for setting the proximity sensitivity. The low sensitivity is 30cm, medium is 70cm, high is 120cm, and difference in +10cm. Options:

- Low**
- Medium**
- High**

Note: When the device is powered on or restarted, the program blocks the sensing area within 10 cm of the device during the first proximity sensing. After the device detects proximity and leave, the blocked area is released.

Parameter “Object type of output value”

This parameter is for setting the object type of output value to the bus when proximity approaching or leaving.

Options:

No reaction

1bit[On/Off]

1byte[scene control]

1byte[0..255]

1byte[0..100%]

Parameter "Output value"

This parameter is visible when "No reaction" is not selected. Set the output value sending to the bus when proximity approaching, the range of value is determined by the data type.

—Parameter "Delay time for sending [0..65535]"

This parameter is visible when "Send a value" is selected. Set the delay time for sending telegram.

Options: **0..65535 s**

Note: During the delay time, telegram only send once when status of proximity approaching has changed.

5.2.3.Parameter window "Advanced setting"



Fig.5.2.3 "Advanced setting" parameter window

Parameter "Logic function"

Setting page of logic function is visible after this parameter enabled.

Parameter "Scene group function"

Setting page of scene group function is visible after this parameter enabled.

5.3.Parameter window “Internal temperature measurement”

Temperature sensor setting	
Temperature calibration	0.0 K
Send temperature when the result change by	1.0 K
Cyclically send temperature [0...255,0=inactive]	10 min
Send alarm telegram for low/high temperature	Respond after read only
Threshold value for low temperature alarm [0..15]	0 °C
Threshold value for high temperature alarm [30..45]	45 °C

Fig.5.3 “Internal temperature measurement” parameter window

The following parameters is used for setting the calibration value, sending condition and error report of internal sensor. If internal sensor is selected for other functions as well, please refer to this section.

Temperature sensor setting

Parameter “Temperature calibration”

This parameter is for setting the temperature calibration value of the internal sensor, that is, to calibrate the measured value of internal sensor to make it closer to the current ambient temperature.

Options:

- 5.0K
- ...
- 0.0K
- ...
- 5.0K

Note: after the device is powered on, the stability time of internal sensor detection will take 30 minutes, therefore, the detected temperature value in the early stage of device work may be inaccurate.

Parameter “Send temperature when the result change by”

This parameter is for setting when temperature turns to a certain value, whether to enable to send the current temperature value to the bus. Not send when disable.

Options:

Disable

0.1K

0.2K

0.3K

0.5K

1.0K

...

10K

Parameter "Cyclically send temperature [0...255,0=inactive]"

Setting the time for cyclically sending the temperature detection value to the bus.

Options: **0..255 min**

This period is independent and starts time counting after programming completion or reset.

Transmission change has no affect on this period.

Parameter "Send alarm telegram for low/high temperature"

This parameter is for setting condition of sending telegram when low/high temperature alarm.

Options:

No respond

Respond after read only

Respond after change

Respond after read only: Only when the device receives a read alarm from other bus device or bus will the object "Low temperature alarm"/" High temperature alarm" send the alarm status to the bus;

Respond after change: the object " Low temperature alarm"/" High temperature alarm" will immediately send the telegram to the bus to report the alarm value when the alarm status has changed.

These two parameters as follow are visible when "Respond after read only" or "Respond after change" are selected.

—Parameter “Threshold value for low temperature alarm [0..15]”

This parameter is for setting the threshold value for low temperature alarm. When the temperature lower than low threshold, low temperature alarm object will send telegram. Options:

0°C

1°C

...

15°C

—Parameter “Threshold value for high temperature alarm [30..45]”

This parameter is for setting the threshold value for high temperature alarm. When the temperature higher than high threshold, high temperature alarm object will send telegram. Options:

30°C

31°C

...

45°C

5.4.Parameter window “Button”

This series of products has several panels, including 1-gang, 2-gang and 3-gang. The function of the button panels is similar, so the 3-gang panel is used as an example below.

Push button type

Panel preview

3-gang

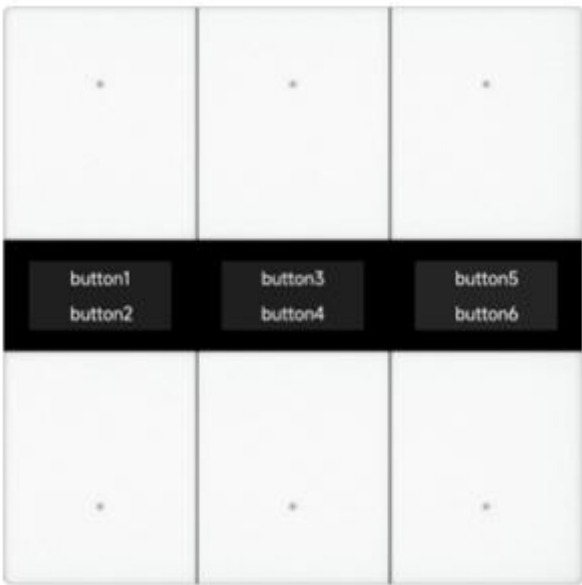

Long operation for button after [3..250] *0.1s

Button 1	<input checked="" type="checkbox"/>
Button 2	<input checked="" type="checkbox"/>
Button 3	<input checked="" type="checkbox"/>
Button 4	<input checked="" type="checkbox"/>
Button 5	<input checked="" type="checkbox"/>
Button 6	<input checked="" type="checkbox"/>

Function of Channel Switch ▾

Description (max 16char.)

Display type Icon + Description of button ▾

Icon General light ▾

Icon preview



Colour of the icon and description White ▾

Fig.5.4“Button” parameter window

Parameter "Push button type"

This parameter is for setting the push button type. Under the parameter, it displays the panel preview picture according the push button type. If the type is 3-gang, shown as Fig.5.4.

—Parameter "Long operation for button after [3..250]"

Button operation is distinguished between long and short operation as default, this parameter is for setting the valid time for long operation. So, when you press longer than the time set here, it will be identified as long operation, otherwise, it will be taken as short operation. Options: **3..250 *0.1s**

Parameter "Button x" (x=1~6)

Following setting is visible after this parameter enabled.

Parameter "Function of button x" (x=1~8)

This parameter is for setting the function of button. Options:

- Switch**
- Dimming**
- RGB switching/send value**
- RGBW switching/send value**
- Colour temperature switching/send value**
- Value sender**
- Scene control**
- Blind**
- Shift register**
- Multiple operation**
- Delay mode**

Parameter "Display type"

This parameter is for setting the display type. Options:

- Description of button**
- Icon only**
- Icon + Description of button**

Parameter "Icon"

Parameter "Icon preview"

This parameter is for setting the icon for button function and you can preview the icon effect in ETS. Options:

General light

Ceiling light

...

Not Disturb

See Chapter 7 for the icon list.

Parameter "Description (max 16char.)"

This parameter is for setting the description of button. Up to input 16 characters. The number of characters displayed is determined by the font size.

Parameter "Colour of the icon and description"

This parameter is displayed according to the display type. Used for setting the colour of the icon and description. Options:

Red

Orange

Green

Cyan blue

Blue

Customized colour 1

White

Customized colour 2

Yellow

Customized colour 3

Cyan

Customized colour 4

Magenta

Customized colour 5

Chapters as follow explain the button functions separately.

5.4.1.Switch

Function of Channel	Switch
Description (max 16char.)	
Display type	Icon + Description of button
Icon	General light
Icon preview	
Colour of the icon and description	White
<hr/>	
Distinction between short and long operation	<input checked="" type="radio"/> No <input type="radio"/> Yes
Reaction on press operation	TOGGLE
Reaction on release operation	No reaction
Number of objects	1
<hr/>	
Disable function	Disable=1/Enable=0
Status LED indication when button disable	<input checked="" type="radio"/> No <input type="radio"/> Flashing

Fig.5.4.1 Parameter setting of switch function

Parameter "Distinction between short and long operation"

This parameter is for setting whether to distinction the contact operation between short and long operation. Options:

No

Yes

When select "Yes", the operation reaches a certain time to determine whether the operation is a long or short operation before the contact performs the setting action.

Parameter "Reaction on short/press operation"

Parameter "Reaction on long/release operation"

These parameters are for setting the performed actions when press/release the contact or long/short operation. The object value is updated when the input is determined.

Options:

No reaction

OFF

ON

TOGGLE

No reaction: No telegrams have been sent.

ON: Send the on telegram.

OFF: Send the off telegram.

TOGGLE: Each operation will alternate between on and off. For example, if the last telegram was sent (or received) for on, then the next operation will trigger a telegram for off. When the switch is operated again, it will send a telegram for on etc., So the switch will always remember the previous state and covert to opposite value during next operation.

Parameter "Number of objects"

This parameter is visible when the parameters "Reaction on short/press operation" and "Reaction on long/release operation" are not both selected "No reaction". Set the number of objects when short/long or press/release operation:

1

2

Parameter "Disable function"

This parameter is for setting trigger value to disable/enable contacts. Options:

Disable

Disable=1/Enable=0

Disable=0/Enable=1

Parameter "Status LED indication when button disable"

This parameter is visible when previous parameter is selected "Disable=1/Enable=0" or "Disable=0/Enable=1". Set the LED indication status when button disable.

Options:

No

Flashing

No: no indication and stay the normal indication status;

Flashing: always flashing until receive the "Enable" telegram it will back to normal indication, the flashing period is 1s on and 1s off.

——**Parameter "LED indication colour"**

This parameter is visible when previous parameter is selected "Flashing". Set the LED indication colour, and when it is a customized colour, you need to configure the the colour in the "Customized colour" interface.Options:

Red	Orange
Green	Cyan blue
Blue	Customized colour 1
White	Customized colour 2
Yellow	Customized colour 3
Cyan	Customized colour 4
Magenta	Customized colour 5

Repeat parameters will not be illustrated in next chapters; the usage is similar.

5.4.2.Dimming

Function of Channel	Dimming
Description (max 16char.)	
Display type	Icon + Description of button
Icon	General light
Icon preview	
Colour of the icon and description	White
Reaction on short operation	TOGGLE
Reaction on long operation	Brighter/Darker
Dimming mode	<input checked="" type="radio"/> Start-Stop dimming <input type="radio"/> Step dimming
Disable function	Disable=1/Enable=0
Status LED indication when button disable	<input checked="" type="radio"/> No <input type="radio"/> Flashing

Fig.5.4.2 Parameter setting of dimming function

Parameter "Reaction on short operation"

This parameter is for setting the the switch value to send when short operation. Options:

No reaction

OFF

ON

TOGGLE

No reaction: No telegrams have been sent.

ON: Send the on telegram.

OFF: Send the off telegram.

TOGGLE: Each operation will alternate between on and off.

Parameter "Reaction on long operation"

This parameter is for setting the the relative dimming value to send when long operation, with dimming brightness or darker; when release the contact stop dimming.

Options:

- No reaction**
- Brighter**
- Darker**
- Brighter/Darker**

No reaction: No telegrams have been sent.

Brighter: The dimming up value will be sent.

Darker: The dimming down value will be sent.

Brighter/Darker: Dimming up and down will be sent alternately.

Note: In "TOGGLE" mode of this parameter setting, the value sent will be linked. For example, if the last value is switching on status, then it will be dimmed down in next dimming operation; if the last value is switching off, then it will be dimmed up in next dimming operation.

Parameter "Dimming mode"

This parameter is visible when previous parameter is not "No reaction". Set the way of relative dimming. Options:

- Start-Stop dimming**
- Step dimming**

Start-stop dimming: The dimming mode will be start-stop, a dimming up or down telegram will be sent when the dimming starts, and a stop telegram will be sent when dimming ends. Here the dimming telegram will not be sent cyclically.

Steps dimming: The dimming mode will be a step one and the dimming telegram will be sent cyclically. When dimming ends, a stop dimming telegram will be sent immediately.

—Parameter " Step size"

This parameter is visible when the dimming way is selected "Step dimming". Set a cyclically sending dimming telegram which changes the brightness percentage, Options:

- 100%**
- 50%**
- ...**
- 1.56%**

—Parameter “Interval of tele. cyclic send [0..25,0=send once]”

This parameter is visible when the dimming way is selected “Step dimming”. Set intervals of two cyclically sending dimming telegram. Options: **0..25 *0.1s, 0=send once**

5.4.3.RGB switching/send value

Fig.5.4.3 Parameter setting of RGB lighting function

Parameter “Object datatype of absolute brightness”

This parameter is for setting the object datatype for RGB lighting. Options:

1x3byte

3x1byte

Parameter “Reaction on short operation”

Parameter “Reaction on long operation”

These parameters are for setting the performed actions when long/short operation.

Options:

- No reaction**
- OFF**
- ON**
- TOGGLE**
- Absolute value**

— Parameter "RGB value"

This parameter is visible when previous parameter is selected "Absolute value". Set the sending RGB value when long/short operation. Options: **#000000..#FFFFFF**

5.4.4.RGBW switching/send value



Function of Channel	RGBW switching/send value
Description (max 16char.)	<input type="text"/>
Display type	Icon + Description of button
Icon	RGB light
Icon preview	
Colour of the icon and description	White
<hr/>	
Object datatype of absolute brightness	<input checked="" type="radio"/> 1x6byte <input type="radio"/> 4x1byte
Reaction on short operation	TOGGLE
Reaction on long operation	Absolute value
RGB Value	<input type="text" value="#FFFFFF"/> 
White Value	255 <input type="range" value="255"/>
<hr/>	
Disable function	Disable=1/Enable=0
Status LED indication when button disable	<input checked="" type="radio"/> No <input type="radio"/> Flashing

Fig.5.4.4 Parameter setting of RGBW lighting function

Parameter "Object datatype of absolute brightness"

This parameter is for setting the object datatype for RGBW lighting. Options:

1x6byte

4x1byte

Parameter "Reaction on short operation"

Parameter "Reaction on long operation"

These parameters are for setting the performed actions when long/short operation. Options:

No reaction

OFF

ON

TOGGLE

Absolute value

— Parameter "RGB value"

This parameter is visible when previous parameter is selected "Absolute value". Set the sending RGB value when long/short operation. Options: **#000000..#FFFFFF**

— Parameter "White Value"

This parameter is visible when previous parameter is selected "Absolute value". Set the sending white brightness value when long/short operation. Options: **0..255**

5.4.5. Colour temperature switching/send value

Function of Channel	Colour temperature switching/send value
Description (max 16char.)	
Display type	Icon + Description of button
Icon	Downlight 1
Icon preview	
Colour of the icon and description	White
Reaction on short operation	TOGGLE
Reaction on long operation	Absolute value
Send brightness value	100 %
Send Colour temperature value	4000 K
Disable function	Disable=1/Enable=0
Status LED indication when button disable	<input checked="" type="radio"/> No <input type="radio"/> Flashing

Fig.5.4.5 Parameter setting of colour temperature control function

Parameter "Reaction on short operation"

Parameter "Reaction on long operation"

These parameters are for setting the performed actions when long/short operation. Options:

No reaction

OFF

ON

TOGGLE

Absolute value

Parameter "Send brightness value"

This parameter is visible when previous parameter is selected "Absolute value". Set the sending brightness value when long/short operation. Options: **0..100%**

Parameter "Send Colour temperature value"

This parameter is visible when previous parameter is selected "Absolute value". Set the sending colour temperature value when long/short operation. Options: **1000...10000K**

5.4.6.Value sender

Function of Channel	Value sender
Description (max 16char.)	<input type="text"/>
Display type	Icon + Description of button
Icon	General light
Icon preview	
Colour of the icon and description	White
<hr/>	
Reaction on short operation	1bit value[ON/OFF]
Value 1	<input type="radio"/> OFF <input checked="" type="radio"/> ON
Reaction on long operation	No reaction
<hr/>	
Disable function	Disable=1/Enable=0
Status LED indication when button disable	<input checked="" type="radio"/> No <input type="radio"/> Flashing

Fig.5.4.6 Parameter setting of value sender

Parameter "Reaction on short operation"
Parameter "Reaction on long operation"

These parameters are for setting the datatype to send when long/short operation. Options:

- No reaction**
- 1bit value[On/Off]**
- 2bit value[0..3]**
- 4bit value[0..15]**
- 1byte value[0..255]**
- 2byte value[0..65535]**

2byte float value

4byte value[0..4294967295]

4byte float value

Parameter "Value 1/2"

These parameters are visible when "No reaction" is not selected. Set the data value to send when perform short/long operation. Range of value is determined according to the previous parameter selected datatype.

5.4.7.Scene control

Function of Channel	Scene control
Description (max 16char.)	
Display type	Icon + Description of button
Icon	General scene 1
Icon preview	
Colour of the icon and description	White
<hr/>	
Reaction on short operation	Recall scene
8 bit scene number	Scene No.1
Reaction on long operation	Store scene
8 bit scene number	Scene No.1
Number of objects	<input checked="" type="radio"/> 1 <input type="radio"/> 2
<hr/>	
Disable function	Disable=1/Enable=0
Status LED indication when button disable	<input checked="" type="radio"/> No <input type="radio"/> Flashing

Fig.5.4.7 Parameter setting of scene function

Parameter "Reaction on short operation"
Parameter "Reaction on long operation"

These parameters are for setting to recall or storage scene when long/short operation. Options:

No reaction

Recall scene

Store scene

— Parameter "8 bit scene number"

This parameter is visible when "No reaction" is not selected. Set the scene number. Options:

Scene NO.1

Scene NO.2

Scene NO.3

...

Scene NO.64

Corresponding telegram is 0~63

Parameter "Number of objects"

This parameter is visible when the parameters "Reaction on short operation" and "Reaction on long operation" is not both selected "No reaction". Set the number of objects when short/long operation:

1

2

5.4.8.Blind

Function of Channel	Blind
Description (max 16char.)	
Display type	Icon + Description of button
Icon	Curtain
Icon preview	
Colour of the icon and description	White
Reaction on short operation	Stop(Adjust Up/Down)
Reaction on long operation	Up/Down
Disable function	Disable=1/Enable=0
Status LED indication when button disable	<input checked="" type="radio"/> No <input type="radio"/> Flashing

Fig.5.4.8 Parameter setting of blind function

Parameter "Reaction on short operation"

Parameter "Reaction on long operation"

These parameters are for setting to performed actions when long/short operation. Options:

No reaction

Up

Down

Up/Down

Stop(Adjust Up)

Stop(Adjust Down)

Stop(Adjust Up/Down)

No reaction: No reaction is performed.

Up: The curtains/blinds will be opened or moved up.

Down: The curtains/blinds will be closed or moved down.

Up/Down: Alternately open/close or move up/down the curtains/blinds.

Stop (Adjust Up): Stop the curtain movement or move up the angle of blinds.

Stop (Adjust Down): Stop the curtain movement or move down the angle of blinds.

Stop (Adjust Up/Down): Stop the curtain movement or move up/down the angle of blinds alternately.

——Parameter “ Interval of tele. cyclic send [0..25,0=send once] ”

This parameter is visible when previous parameter is selected “Stop...”. Set the time interval of cyclical blinds angle adjustment telegram sent. Options: **0..25 *0.1s,0=send once**

5.4.9.Shift register

Function of Channel	Shift register
Description (max 16char.)	
Display type	Icon + Description of button
Icon	General light
Icon preview	
Colour of the icon and description	White
Shift type	<input checked="" type="radio"/> Shift by step value <input type="radio"/> Shift without step value
Value begin with	0
Value end with(must be larger than value begin with)	10
Step size	2
Direction	From lowest to highest and cyclically
Reset function	<input checked="" type="radio"/> Disable <input type="radio"/> Enable by long operation
Disable function	Disable=1/Enable=0
Status LED indication when button disable	<input checked="" type="radio"/> No <input type="radio"/> Flashing

Shift by step value

Function of Channel	Shift register
Description (max 16char.)	
Display type	Icon + Description of button
Icon	General light
Icon preview	
Colour of the icon and description	White
Shift type	<input type="radio"/> Shift by step value <input checked="" type="radio"/> Shift without step value
Object datatype	1byte unsigned value
Shift number	1
Value 1	0
Direction	From lowest to highest and cyclically
Reset function	<input checked="" type="radio"/> Disable <input type="radio"/> Enable by long operation
Disable function	Disable=1/Enable=0
Status LED indication when button disable	<input checked="" type="radio"/> No <input type="radio"/> Flashing

Shift without step value

Fig.5.4.9 Parameter setting of shift register function

Parameter "Shift type"

This parameter is for setting the shift type. Options:

Shift by step value

Shift without step value

Shift by step value: Here the lowest value and highest value of shift can be set, the value increased (from lowest to highest) or decreased (from highest to lowest) from every shift can also be set.

Shift without step value: When there's no step value, the actual value sent by each shift can be set (max. 10 value), in every operation one value will be sent.

Three parameters as follow are visible when "Shift by step value" is selected

—Parameter "Value begin with"

This parameter is for setting the lowest value of the shift. Options: **0..240**

—Parameter “Value end with(must be larger than value begin with)”

This parameter is for setting the highest value of the shift. Options: **1..250**

The highest value must be larger than lowest value.

—Parameter “Step size”

This parameter is for setting the increase (from low to high) or decrease (from high to low) value.

Options: **0..240**

Parameters as follow are visible when “Shift without step value” is selected

Parameter “Object datatype”

This parameter is for setting the object datatype for the shift object.

Option is only **1byte unsigned value/Scene number/HVAC mode**

—Parameter “Shift number”

This parameter is for setting the number of shift, up to set maximum 10 values, Options: **0/1/2../10**

—Parameter “Value x”(x=1~10)

This parameter is for setting the value when each shift operation to send,display according to data type. Options: **0..255/Scene No.1~64/Comfort mode/Standby mode/Economy mode/Frost/heat protection**

Parameter “Direction”

This parameter is for setting the shift direction. Options:

From lowest to highest and stop to the end

From highest to lowest and stop to the begin

From lowest to highest and cyclically

From highest to lowest and cyclically

From lowest to highest and stop to the end: Shift from low to high.

From highest to lowest and stop to the begin: Shift from high to low.

From lowest to highest and cyclically: once to the end value, shift direction starts over again and constantly cycling from low to high operation.

From highest to lowest and cyclically: once to the start value, shift direction starts over again and constantly cycling from high to low operation.

Parameter "Reset function"

This parameter is for setting whether to enable shift reset function. Options:

Disable

Enable by long operation

Disable: Not possible to reset shift;

Enable by long operation: Possible to reset shift by long operation, when reset, shift will start new.

5.4.10. Multiple operation

Function of Channel	Multiple operation
Description (max 16char.)	
Display type	Icon + Description of button
Icon	General light
Icon preview	
Colour of the icon and description	White
Object type for object1	1Bit_On/Off
Function of short operation	TOGGLE
Function of long operation	No reaction
Object type for object2	Disable
Object type for object3	Disable
Object type for object4	Disable
Disable function	Disable=1/Enable=0
Status LED indication when button disable	<input checked="" type="radio"/> No <input type="radio"/> Flashing

Fig.5.4.10 Parameter setting of multiple operation function

Parameter "Object type for object x" (x=1~4)

This parameter is for setting the datatype when long/short operation to send. Options:

- Disable**
- 1Bit_On/Off**
- 1Bit_Up/Down**
- 1Byte_RecallScene**
- 1Byte_StoreScene**
- 1Byte_Percentage**
- 1Byte_Unsigned value**

——Parameter "Function of short operation"

——Parameter "Function of long operation"

This parameter is for setting the specific values to send when perform the operation, either no action or sending value (the specific value will be set in next parameter).

——Parameter "Value x..." (x=1~2)

This parameter is visible when object type is selected "1byte_RecallScene", "1byte_StoreScene", "1byte_Percentage", "1byte_Unsigned value". Set sending values when perform operations. The range of value is up to the datatype selected by the parameter before last one.

5.4.11.Delay mode

Function of Channel	Delay mode
Description (max 16char.)	
Display type	Icon + Description of button
Icon	General light
Icon preview	
Colour of the icon and description	White
Object type for short operation	1Bit_On/Off
Send mode	No action when operation,delay then send value1
Delay time [0..6500]	10 s
Value 1	<input checked="" type="radio"/> OFF <input type="radio"/> ON
Value 2	<input type="radio"/> OFF <input checked="" type="radio"/> ON
Object type for long operation	Disable
Disable function	Disable=1/Enable=0
Status LED indication when button disable	<input checked="" type="radio"/> No <input type="radio"/> Flashing

Fig.5.4.11 Parameter setting of delay mode function

Parameter "Object type for short operation"

Parameter "Object type for long operation"

These parameters are for setting the datatype when long/short operation to send. Options:

- Disable**
- 1Bit_On/Off**
- 4Bit_Dimming**
- 1Byte_Unsigned value**

Parameter " Send mode"

This parameter is for setting the send mode. Options:

- No action when operation,delay then send value1**
- No action when operation,delay then send value2**

Send value1 when operation,delay then send value2

Send value2 when operation,delay then send value1

Parameter "Delay time [0..6500]"

This parameter is for setting the delay time. Options: **0..6500 s**

Parameter "Value x" (x=1~2)

This parameter is for setting the value 1/2 to send. The range of value is up to the datatype selected by the parameters.

5.4.12.LED indication

Status LED indication	Control by button switch object
When object value="0", LED is	OFF
When object value="1", LED is	Blue

Control by button switch object

Status LED indication	Control by external object
External object datatype	<input checked="" type="radio"/> 1bit <input type="radio"/> 1byte
When object value="0", LED is	OFF
When object value="1", LED is	Blue

Status LED indication	Control by external object
External object datatype	<input type="radio"/> 1bit <input checked="" type="radio"/> 1byte
Threshold value is	50
If object value<threshold value, LED is	OFF
If object value=threshold value, LED is	Red
If object value>threshold value, LED is	OFF

Control by external object

Status LED indication	Indicate button press
When press the button,indicator is	<input checked="" type="radio"/> On <input type="radio"/> Flashing
On duration time is	1s
LED indication colour	Red

Indicate button press-On

Status LED indication	Indicate button press
When press the button,indicator is	<input type="radio"/> On <input checked="" type="radio"/> Flashing
Flashing period time is	0.8 s
Normal indication is	<input checked="" type="radio"/> OFF <input type="radio"/> ON
LED indication colour	Red

Indicate button press-Flashing

Status LED indication	Always on
LED indication colour	Red

Always on

Fig.5.4.12 Parameter setting of LED indication function

Parameter "Status LED indication"

This parameter is for setting the LED indication status. When button function set with switch function, such as switch, dimming function. Options:

- Disable**
- Control by button switch object**
- Control by external object**
- Indicate button press**
- Always on**

There is no option "Control by button switch object" when not with switch function, such as scene, blind, value sender, delay mode and etc.

Parameters as follow are visible when LED indication status is selected "Control by button switch object".

- Parameter "When object value="0", LED is"
- Parameter "When object value="1", LED is"

These parameters are for setting the LED indication colour according to switch function and

dimming function. Options:

OFF	Orange
Red	Cyan blue
Green	Customized colour 1
Blue	Customized colour 2
White	Customized colour 3
Yellow	Customized colour 4
Cyan	Customized colour 5
Magenta	

Parameters as follow are visible when LED indication status is selected "Control by external object".

—Parameter "External object datatype"

This parameter is for setting the external object datatype. Options:

- 1bit**
- 1byte**

Note: The object will send read request when the device power on, indicate according to the response value, and no handled when no receive a response.

Two parameters as follow are visible when 1 bit is selected.

- Parameter "When object value="0", LED is"
- Parameter "When object value="1", LED is"

These parameters are for setting the LED indication colour according to 1 bit object value from the bus.

Options:

OFF	Orange
Red	Cyan blue
Green	Customized colour 1
Blue	Customized colour 2
White	Customized colour 3
Yellow	Customized colour 4
Cyan	Customized colour 5
OFF	

Four parameters as follow are visible when 1 byte is selected.

—Parameter “Threshold value is”

This parameter is for setting the threshold value. Options: 1..255

—Parameter “If object value<threshold value, LED is”

—Parameter “ If object value=threshold value, LED is”

—Parameter “ If object value>threshold value, LED is”

These parameters are for setting the LED indication colour according to the comparison of both the object value and the threshold value. Options:

OFF	Orange
Red	Cyan blue
Green	Customized colour 1
Blue	Customized colour 2
White	Customized colour 3
Yellow	Customized colour 4
Cyan	Customized colour 5
OFF	

Parameters as follow are visible when LED indication status is selected "Indicate button press".

—Parameter "When press the button,indicator is"

This parameter is for setting the LED indication status when press the button. Options:

On

Flashing

Parameter as follow is visible when On is selected.

—Parameter "On duration time is"

This parameter is for setting the LED on duration time. Options:

500ms

1s

2s

3s

Parameters as follow are visible when Flashing is selected.

—Parameter "Flashing period time is"

This parameter is for setting the LED flashing period time. options:

0.4s

0.8s

...

2.0s

—Parameter "Normal indication is"

This parameter is for setting the LED normal indication when finish flashing. Options:

OFF

ON

Parameter as follow is visible when LED indication status is selected “Indicate button press” or “Always on”.

Parameter “LED indication colour”

This parameter is for setting the LED indication colour. Options:

- | | |
|----------------|----------------------------|
| Red | Orange |
| Green | Cyan blue |
| Blue | Customized colour 1 |
| White | Customized colour 2 |
| Yellow | Customized colour 3 |
| Cyan | Customized colour 4 |
| Magenta | Customized colour 5 |

5.4.13.Parameter window “Customized colour”

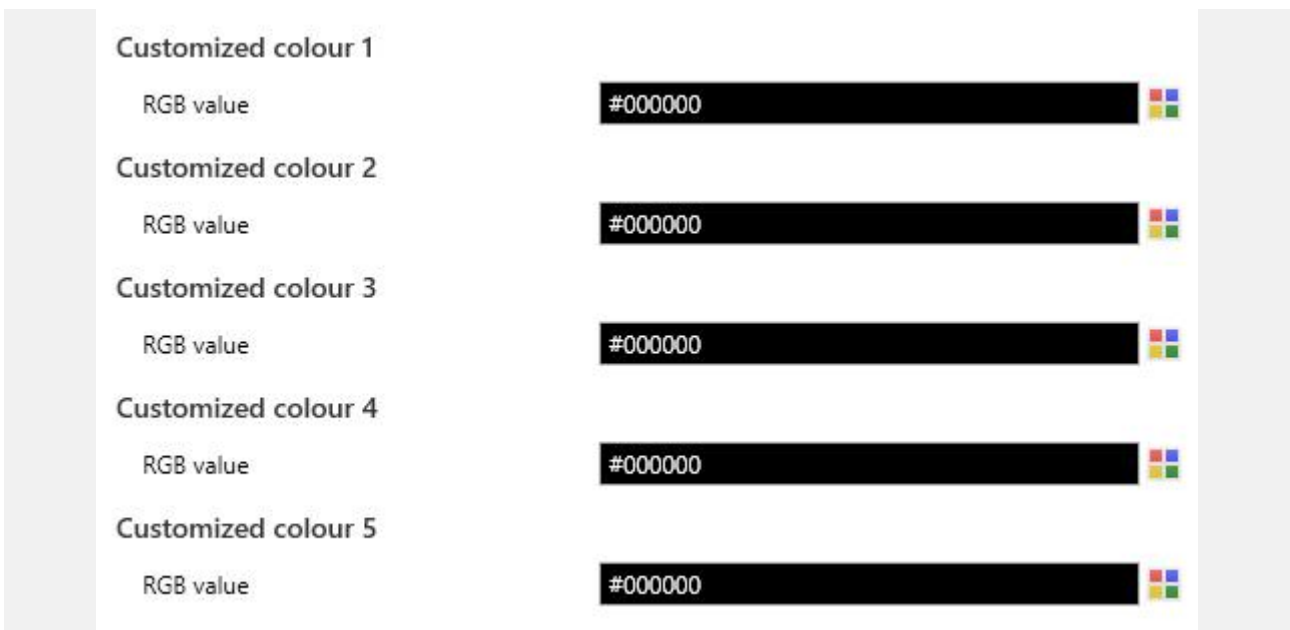

Fig.5.4.13 “Customized colour” parameter window

Customized colour x (x=1~5)

Parameter “RGB value”

This parameter is for setting the customized colour of LED indication, user up to define 5 colours.

Options: #000000#FFFFFF

5.5.Parameter window “Logic”

The screenshot shows a parameter window titled "Logic". It contains the following elements:

- 1st Logic function
- 2nd Logic function
- 3rd Logic function
- 4th Logic function
- 5th Logic function
- 6th Logic function
- 7th Logic function
- 8th Logic function
- Description for logic function:
- Function of channel: **AND** (dropdown menu)

Fig.5.5 “Logic function setting” parameter window

Parameter “1st/2nd/3rd... Logic function”

This parameter is for setting the setting interface of logic function, display corresponding logic function page when select. Up to enable 8 logic functions.

Parameter “Description for logic function”

This parameter is for setting the name description for logic function, up to input 30 characters.

Parameter “Function of channel”

This parameter is for setting function of the channel. Options:

- AND**
- OR**
- XOR**
- Gate forwarding**
- Threshold comparator**
- Format convert**
- Gate function**
- Delay function**
- Staircase lighting**

AND/OR/XOR: as the parameter is similar to the communication object (only the logic algorithm is different), the following parameters taking one options for example.

5.5.1.Parameter window “AND/OR/XOR”

Description for logic function	<input type="text"/>
Function of channel	AND ▾
Input a	Disconnected ▾
Default value	<input checked="" type="radio"/> 0 <input type="radio"/> 1
Input b	Disconnected ▾
Default value	<input checked="" type="radio"/> 0 <input type="radio"/> 1
Input c	Disconnected ▾
Default value	<input checked="" type="radio"/> 0 <input type="radio"/> 1
Input d	Disconnected ▾
Default value	<input checked="" type="radio"/> 0 <input type="radio"/> 1
Input e	Disconnected ▾
Default value	<input checked="" type="radio"/> 0 <input type="radio"/> 1
Input f	Disconnected ▾
Default value	<input checked="" type="radio"/> 0 <input type="radio"/> 1
Input g	Disconnected ▾
Default value	<input checked="" type="radio"/> 0 <input type="radio"/> 1
Input h	Disconnected ▾
Default value	<input checked="" type="radio"/> 0 <input type="radio"/> 1
<hr/>	
Result is inverted	<input checked="" type="radio"/> No <input type="radio"/> Yes
Read input object value after voltage recovery	<input checked="" type="radio"/> No <input type="radio"/> Yes
Output send when	<input checked="" type="radio"/> Receiving a new telegram <input type="radio"/> Every change of output object
Send delay time: Base	None ▾
Factor: 1..255	<input type="text" value="1"/>

Fig.5.5.1 “AND/OR/XOR” parameter window

Parameter "Input a/b/c/d/e/f/g/h"

This parameter is for setting whether input x to calculate, whether to normally calculate or inverted calculate. Options:

Disconnected

Normal

Inverted

Disconnected: not to calculate;

Normal: to directly calculate the input value;

Inverted: invert the input value, then to calculate. **Note: not to invert the initiate value.**

Parameter "Default value"

This parameter is for setting the initial value of logic input x. Options:

0

1

Parameter "Result is inverted"

This parameter is for setting whether to invert the logic calculation result. Options:

No

Yes

No: output directly;

Yes: output after inverting.

Parameter "Read input object value after bus voltage recovery"

This parameter is for setting whether to send the read request to the logic input object after device voltage recovery or finish programming. Options:

No

Yes

Parameter "Output send when"

This parameter is for setting the condition of sending logic result. Options:

Receiving a new telegram

Every change of output object

Receiving a new telegram: every time the object received a new input value will the logic result be sent to the bus;

Every change of output object: only when logic result has changed will it be sent to the bus.

Tip: when in the first time to logic calculate, the logic result will be sent even if it has no change.

Parameter "Send delay time"

Base: **None**

0.1s

1s

...

10s

25s

Factor: **1..255**

This parameter is for setting the delay time for sending the logic calculation result to the bus. Delay time = Base × Factor, if option "None" of Base is selected, then there is no delay.

5.5.2.Parameter window “Gate forwarding”

Description for logic function	<input type="text"/>
Function of channel	Gate forwarding ▼
Object type of Input/Output	1bit ▼
Default scene NO. of Gate after startup [1~64,0=inactive]	0 ▲▼
<hr/>	
1->Gate trigger scene NO. is [1~64,0=inactive]	0 ▲▼
Input A send on	Output A ▼
Input B send on	Output B ▼
Input C send on	Output C ▼
Input D send on	Output D ▼
<hr/>	
2->Gate trigger scene NO. is [1~64,0=inactive]	0 ▲▼
Input A send on	Output A ▼
Input B send on	Output B ▼
Input C send on	Output C ▼
Input D send on	Output D ▼

Fig.5.5.2 “Gate forwarding” parameter window

Parameter “Object type of Input/Output”

This parameter is for setting the object type of input/output. Options:

- 1bit**
- 4bit**
- 1byte**

Parameter “Default scene NO. of Gate after startup [1~64,0=inactive]”

This parameter is for setting the initial scene where logical gate forwarding can be performed by default after device starts, which needs to be configured in the parameters. Options: **1..64, 0=inactive**

Note: gate scene is recommended to be selected before operating, or it will enable the initiate scene by default.

Parameter "z->Gate trigger scene NO. is [1~64,0=inactive]" (z=1~8)

This parameter is for setting scene number of logic gate forwarding. Up to 8 trigger scene number can be set for each logic. Options: **1..64, 0=inactive**

Parameter "Input A/B/C/D send on"

This parameter is for setting the output of input X (X=A/B/C/D) after gate forwarding. Options:

Output A

Output B

...

Output B,C,D

According to the options, one input can be forwarded into one or more outputs, the output value is the same as the input value.

5.5.3.Parameter window "Threshold comparator"

Description for logic function	
Function of channel	Threshold comparator
Threshold value data type	1byte unsigned value (DPT5.010)
Threshold value	0
If Object value<Threshold value	Do not send telegram
If Object value=Threshold value	Do not send telegram
If Object value!=Threshold value	Do not send telegram
If Object value>Threshold value	Do not send telegram
If Object value<=Threshold value	Do not send telegram
If Object value>=Threshold value	Do not send telegram
Output send when	<input checked="" type="radio"/> Receiving a new telegram <input type="radio"/> Every change of output object
Send delay time: Base	None
Factor: 1..255	1

Fig.5.5.3 "Threshold comparator" parameter window

Parameter "Threshold value data type"

This parameter is for setting the threshold value data type. Options:

- | | |
|----------------------------------------|--------------------------------------------|
| 4bit value (DPT3.007) | 4byte unsigned value[0..4294967295] |
| 1byte unsigned value (DPT5.010) | Ext. temperature value (DPT 9.001) |
| 2byte unsigned value (DPT7.001) | Ext. humidity value (DPT 9.007) |
| 2byte signed value (DPT8.x) | Illuminance value (DPT 9.004) |
| 2byte float value (DPT9.x) | |

Parameter "Threshold value "

This parameter is for setting threshold value, the range depends on the data type. Options:

- 4bit value (DPT3.007) 0..15 / 1byte unsigned value (DPT5.010) 0..255 /**
2byte unsigned value (DPT7.001) 0..65535 / 2byte signed value (DPT8.x) -32768..32767 /
2byte float value (DPT9.x) -670760...670760 / 4byte unsigned value[0..4294967295]
0..4294967295 /
Ext. temperature value (DPT 9.001) -20..95°C / Ext. humidity value (DPT 9.007) 0..100% /
Illuminance value (DPT 9.004) 0..65535lux

Parameter "Hysteresis threshold value"

This parameter is visible when object datatype is selected "2byte float value (DPT9.x)", "Illuminance value (DPT 9.004)". Set the hysteresis threshold value. Options: **0..500**

Parameter "If Object value<Threshold value"

Parameter "If Object value=Threshold value"

Parameter "If Object value!=Threshold value"

Parameter "If Object value>Threshold value"

Parameter "If Object value<=Threshold value"

Parameter "If Object value>=Threshold value"

This parameter is for setting the logic result value that should be sent when threshold value Less than, equal to, not equal to, greater than, less than or equal to the setting valve. When object datatype is selected "2byte float value (DPT9.x)", can only set the object value less than or greater than threshold value. Options:

Do not send telegram

Send value "0"

Send value "1"

Do not send telegram: not consider to select this option;

Send value "0"/"1": when condition is satisfied, send telegram 0 or 1.

If there is a conflict between the setting options between parameters, the base on the value that should be sent when reach the final parameter condition. **For example: parameter "If Object value=Threshold value" is set to be "Send value "0" "; parameter "If Object value<=Threshold value" is set to be "Send value "1" "; when object value is equal to the threshold value, then the logic result will send "1".**

Parameter "Output send when"

This parameter is for setting the condition of sending logic result. Options:

Receiving a new telegram

Every change of output object

Receiving a new telegram: every time the object received a new input value will the logic result be sent to the bus;

Every change of output object: only when logic result has changed will it be sent to the bus.

Tip: when in the first time to logic algorithm, the logic result will be sent even if it has no change.

Parameter "Send delay time"

Base: None

0.1s

1s

...

10s

25s

Factor: 1..255

This parameter is for setting the delay time for sending the logic algorithm result to the bus. Delay time = Base x Factor, if option "None" of Base is selected, then there is no delay.

5.5.4.Parameter window “Format convert”

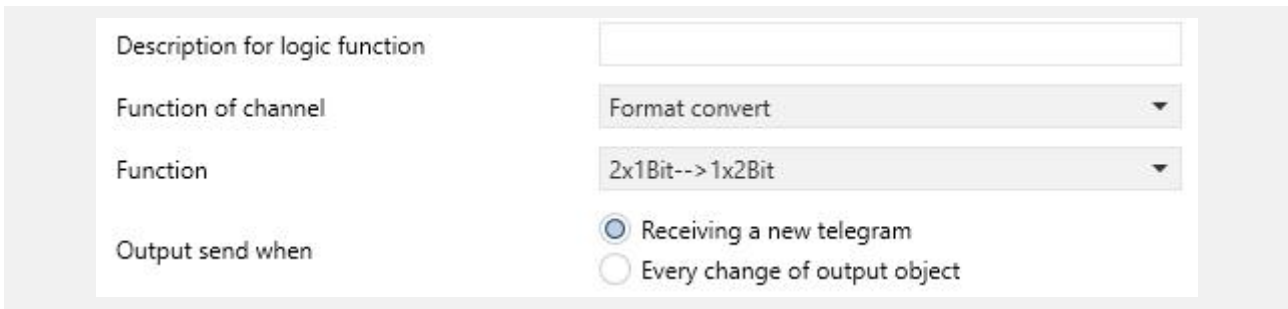

Fig.5.5.4 “Format convert” parameter window

Parameter “Function”

This parameter is for setting the format convert type. Options:

- 2x1bit-->1x2bit**
- 8x1bit-->1x1byte**
- 1x1byte-->1x2byte**
- 2x1byte-->1x2byte**
- 2x2byte-->1x4byte**
- 1x1byte-->8x1bit**
- 1x2byte-->2x1byte**
- 1x4byte-->2x2byte**
- 1x3byte-->3x1byte**
- 3x1byte-->1x3byte**

Parameter “Output send when”

This parameter is for setting the condition of sending logic result. Options:

- Receiving a new telegram**
- Every change of output object**

Receiving a new telegram: every time the object received a new input value will the logic result be sent to the bus;

Every change of output object: only when logic result has changed will it be sent to the bus.

Tip: when in the first time to logic algorithm, the logic result will be sent even if it has no change.

5.5.5.Parameter window “Gate function”

Description for logic function	<input type="text"/>
Function of channel	Gate function ▼
Object type of Input/Output	1bit[On/Off] ▼
Filter function	Deactivate ▼
Value output	<input checked="" type="radio"/> Normal <input type="radio"/> Inverted
Gate object value	<input checked="" type="radio"/> Normal <input type="radio"/> Inverted
Gate status after voltage recovery	<input type="radio"/> Disable <input checked="" type="radio"/> Enable
Save input signal when gate close	<input checked="" type="radio"/> No <input type="radio"/> Yes

Fig.5.5.5 “Gate function” parameter window

Parameter “Object type of Input/Output”

This parameter is for setting the object type of input/output. Options:

1bit[On/Off]

1byte[0..100%]

1byte[0..255]

2byte[Float]

2byte[0..65535]

Parameter “Filter function”

This parameter is visible when “1bit[On/Off]” is selected. Set whether to filter On or Off telegram, only pass one of them or pass all. Options:

Deactivate

On filter out

Off filter out

Deactivate: Do not filter the On or Off telegrams;

On filter out: Off can pass, On cannot pass;

Off filter out: On can pass, Off cannot pass.

Parameter “Value output”

This parameter is visible when “1bit[On/Off]” is selected. Set whether to invert the value then output it. Options:

Normal

Inverted

Parameter "Gate object value"

This parameter is for setting whether to invert the gate object value then output it. Options:

Normal

Inverted

Parameter "Gate status after voltage recovery"

This parameter is for setting the gate status after power on. Options:

Disable

Enable

Parameter "Save input signal when gate close"

This parameter is for setting whether to save input signal on gate close. Options:

No

Yes

No: disable to save the input, the input values received during the gate closing period are ignored;

Yes: enable to save the input, the input values received during the gate closing period are output when gate is open (whether the input value is changed or not).

5.5.6.Parameter window "Delay function"

Description for logic function	<input type="text"/>
Function of channel	Delay function ▼
Object type of Input/Output	1bit[On/Off] ▼
Delay time [0..6500]	10 ▲▼ s

Fig.5.5.6 "Delay function" parameter window

Parameter "Object type of Input/Output"

This parameter is for setting the object type of input/output. Options:

1bit[On/Off]

1byte[0..100%]

1byte[0..255]

2byte[Float]

2byte[0..65535]

Parameter "Delay time [0..6500]"

This parameter is for setting the delay time that output object forwards the value when the input object receives the telegram. Options: **0..6500 s**

Note: Receive telegram again in delay time, re-timing.

5.5.7.Parameter window "Staircase lighting"

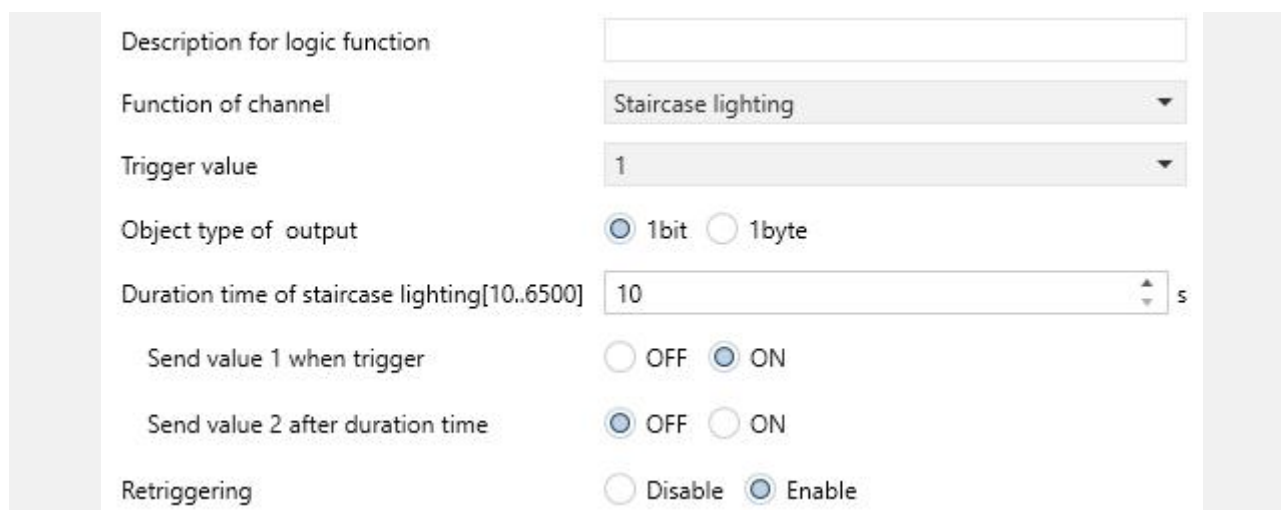

The screenshot shows a parameter configuration window for 'Staircase lighting'. The fields are as follows:

- Description for logic function: [Empty text box]
- Function of channel: Staircase lighting (dropdown menu)
- Trigger value: 1 (dropdown menu)
- Object type of output: 1bit (radio button selected), 1byte (radio button unselected)
- Duration time of staircase lighting[10..6500]: 10 (spin box), s
- Send value 1 when trigger: OFF (radio button unselected), ON (radio button selected)
- Send value 2 after duration time: OFF (radio button selected), ON (radio button unselected)
- Retriggering: Disable (radio button unselected), Enable (radio button selected)

Fig.5.5.7 "Staircase lighting" parameter window

Parameter "Trigger value"

This parameter is for setting the telegram value of the object "Trigger value". Options:

- 0**
- 1**
- 0 or 1**

Parameter "Object type of output"

This parameter is for setting the object type of output. Options:

- 1bit**
- 1byte**

Parameter "Duration time of staircase lighting[10..6500]s"

This parameter is for setting duration time of staircase lighting after the stair light power on.

Options: **10..6500**

—Parameter "Send value 1 when trigger"

—Parameter "Send value 2 after duration time"

These parameters are for setting the value to send. Send value 1 when trigger, and then send value 2 after duration time. Options display according to the output object datatype.

When 1 bit, options:

OFF

ON

When 1 byte , options: **0..255**

Parameter "Retriggering"

This parameter is for setting whether to trigger re-timing when received trigger value in delay time.

Options:

Disable

Enable

5.6.Parameter window “Scene Group”

Scene Group 1 Function	<input checked="" type="checkbox"/>
Scene Group 2 Function	<input type="checkbox"/>
Scene Group 3 Function	<input type="checkbox"/>
Scene Group 4 Function	<input type="checkbox"/>
Scene Group 5 Function	<input type="checkbox"/>
Scene Group 6 Function	<input type="checkbox"/>
Scene Group 7 Function	<input type="checkbox"/>
Scene Group 8 Function	<input type="checkbox"/>
Output 1 Function	<input checked="" type="checkbox"/>
Output 2 Function	<input type="checkbox"/>
Output 3 Function	<input type="checkbox"/>
Output 4 Function	<input type="checkbox"/>
Output 5 Function	<input type="checkbox"/>
Output 6 Function	<input type="checkbox"/>
Output 7 Function	<input type="checkbox"/>
Output 8 Function	<input type="checkbox"/>
Description for Output 1 function	<input type="text"/>
Object type of Output 1	1bit
1->Output 1 trigger scene NO. is [1~64,0=inactive]	0
Object value of Output 1	<input checked="" type="radio"/> 0 <input type="radio"/> 1
Delay time for sending [0..255]	0 *0.1s
2->Output 1 trigger scene NO. is [1~64,0=inactive]	0
Object value of Output 1	<input checked="" type="radio"/> 0 <input type="radio"/> 1
Delay time for sending [0..255]	0 *0.1s

Fig.5.6 “Scene Group” parameter window

Parameter “Scene Group x Function”(x=1~8)

This parameter is for setting whether to enable scene group x function, up to 8 scene groups.

Parameter “Output y Function”(y=1~8)

This parameter is for setting whether to enable output y of scene group x, up to 8 output functions for each scene group.

As 8 group functions are the same, and 8 output functions of each group as well, the following description only about one output of a group.

Parameter "Description for Output y function"(y=1~8)

This parameter is for setting the name description for output y of group x, up to input 30 characters.

Parameter "Object type of Output y"(y=1~8)

This parameter is for setting the object type of output y of group x. Options:

1bit

1byte

2byte

Parameter "Object datatype"

This parameter is for setting the datatype of 1byte or 2byte.

When the datatype is 1byte, options:

1byte unsigned value

HVAC mode

When the datatype is 2byte, options:

2byte unsigned value

Temperature value

Parameter "z->Output y trigger scene NO. is [1~64,0=inactive]"(z=1~8)

This parameter is for setting the triggered scene number of output y of group x. Up to 8 triggered scene of each output can be configured. Options:**0..64, 0=inactive**

Parameter "Object value of Output y"

This parameter is for setting the output value, the range depends on the data type of output y.

When the datatype is 1bit, options: **0..1**

When the datatype is 1byte-1byte unsigned value, options: **0..255**

When the datatype is 1byte-HVAC mode, options:

Comfort mode

Standby mode

Economy mode

Frost/heat protection

When the datatype is 2byte-2byte unsigned value, options: **0..65535**

When the datatype is 2byte-Temperature value, options:

-5°C

-4°C

...

45°C

— Parameter "Delay time for sending [0..255]*0.1s"

This parameter is for setting the delay time for sending the output value to the bus. Options: **0..255**

Chapter 6 Description of Communication Object

The communication object is the medium to communicate other device on the bus, namely only the communication object can communicate with the bus.

NOTE: “C” in “Flag” column in the below table means enable the communication function of the object; “W” means value of object can be written from the bus; “R” means the value of the object can be read by the other devices; “T” means the object has the transmission function; “U” means the value of the object can be updated.

6.1.“General” Communication Object

Nur	Name	Object Function	Description	Group Address	Length	C	R	W	T	U	I	Data Type	Priority
1	General	In operation			1 bit	C	R	-	T	-	-	switch	Low
184	Extension function	Night mode			1 bit	C	-	W	T	U	-	day/night	Low
185	Extension function	Dis/En Proximity function			1 bit	C	-	W	-	-	-	enable	Low
186	Extension function	Proximity input			1 bit	C	-	W	-	-	-	switch	Low
187	Extension function	Proximity output			1 bit	C	-	-	T	-	-	switch	Low
188	Extension function	Panel orientation indication			1 bit	C	-	W	-	-	-	trigger	Low
189	Extension function	Screen on/off			1 bit	C	-	W	-	-	-	switch	Low

Fig.6.1 “General” communication object

NO.	Object Function	Name	Data Type	Flag	DPT
1	In operation	General	1bit	C,R,T	1.001 switch
<p>The communication object is used to periodically send a telegram “1” to the bus to indicate that the device is working properly.</p>					
184	Night mode	Extension function	1bit	C,W C,W,T,U	1.024 day/night
<p>This communication object is used to send day/night status to the bus. Telegram value:</p> <p style="text-align: center;">0 — Day</p> <p style="text-align: center;">1 — Night</p> <p>The object flag is C,W when send read request is disabled; The object flag is C,W,T,U when it is enabled.</p>					
185	Dis/En Proximity function	Extension function	1bit	C,W	1.003 enable
<p>The communication object is used to enable/disable proximity function.</p>					

186	Proximity input	Extension function	1bit	C,W	1.001 switch
<p>The communication object is visible when proximity function is triggered by the object. Receive the telegram value from bus:</p> <p style="padding-left: 40px;">1—Trigger proximity function</p> <p style="padding-left: 40px;">0—Leaving (No proximity)</p>					
187	Proximity output	Extension function	1bit 1byte	C,T	1.001 switch 5.010 counter pulses 17.001 scene number 5.001 percentage
<p>The communication object is determined by the parameter “Object type of output value”. When detect the reaction for proximity approaching, the object can send the parameter setting value(1 byte) or ON(1 bit) to the bus separately. The range of value is determined by the selected data type.</p>					
188	Panel orientation indication	Extension function	1bit	C,W	1.017 trigger
<p>This communication object is used to receive the telegrams from the bus that trigger panel orientation indication function. Telegram value is set by the parameter.</p>					
189	Screen on/off Screen&LED on/off	Extension function	1bit	C,W	1.001 switch
<p>The communication object is displayed according to the parameter settings, used to receive the telegrams from bus to control screen on/off, or control LED indicate at the same time. Telegram value:</p> <p style="padding-left: 40px;">0 —Off</p> <p style="padding-left: 40px;">1 —On</p>					

Table 6.1 “General” communication object table

6.2. "Internal sensor" Communication Object

Number	Name	Object Function	Descr	Group	Length	C	R	W	T	U	Data Type	Priority
2	Internal sensor	Temperature value			2 bytes	C	R	-	T	-	temperature (°C)	Low
3	Internal sensor	Low temperature alarm			1 bit	C	R	-	T	-	alarm	Low
4	Internal sensor	High temperature alarm			1 bit	C	R	-	T	-	alarm	Low

Fig.6.2 "Internal sensor" communication object

NO.	Object Function	Name	Data Type	Flag	DPT
2	Temperature value	Internal sensor	2byte	C,R,T	9.001 temperature
The communication object is used for transmitting the temperature value detected by the built-in temperature sensor of the device to the bus. Range:-50~99.8°C					
3	Low temperature alarm	Internal sensor	1bit	C,R,T	1.005 alarm
The communication object is used to send the low temperature alarm signal to bus, when temperature lower than low threshold that defined by parameter.					
4	High temperature alarm	Internal sensor	1bit	C,R,T	1.005 alarm
The communication object is used to send the high temperature alarm signal to bus, when temperature higher than high threshold that defined by parameter.					

Table 6.2 "Internal sensor" communication object table

6.3. "Button" Communication Object

Number	Name	Object Function	Descr	Group #	Length	C	R	W	T	U	Data Type	Priority
142	Button 1 - Switching	Switch			1 bit	C	-	W	T	U	switch	Low
142	Button 1 - Switching	Press, Switch			1 bit	C	-	W	T	U	switch	Low
143	Button 1 - Switching	Release, Switch			1 bit	C	-	W	T	U	switch	Low
142	Button 1 - Switching	Short, Switch			1 bit	C	-	W	T	U	switch	Low
143	Button 1 - Switching	Long, Switch			1 bit	C	-	W	T	U	switch	Low
147	Button 1 - Switching	Disable			1 bit	C	-	W	-	-	enable	Low
148	Button 1 - Switching	LED status			1 bit	C	-	W	T	U	switch	Low

Switching

Number	Name	Object Function	Descr	Group #	Length	C	R	W	T	U	Data Type	Priority
142	Button 1 - Dimming	Short, Switch			1 bit	C	-	W	T	U	switch	Low
143	Button 1 - Dimming	Long, Dimming			4 bit	C	-	W	T	-	dimming control	Low
147	Button 1 - Dimming	Disable			1 bit	C	-	W	-	-	enable	Low
148	Button 1 - Dimming	LED status			1 bit	C	-	W	T	U	switch	Low

Dimming

Number	Name	Object Function	Descr	Group #	Length	C	R	W	T	U	Data Type	Priority
142	Button 1 - RGB	Switch			1 bit	C	-	W	T	U	switch	Low
143	Button 1 - RGB	RGB dimming value			3 bytes	C	-	-	T	-	RGB value 3x(0..255)	Low
143	Button 1 - RGB	Red dimming value			1 byte	C	-	-	T	-	percentage (0..100%)	Low
144	Button 1 - RGB	Green dimming value			1 byte	C	-	-	T	-	percentage (0..100%)	Low
145	Button 1 - RGB	Blue dimming value			1 byte	C	-	-	T	-	percentage (0..100%)	Low
147	Button 1 - RGB	Disable			1 bit	C	-	W	-	-	enable	Low
148	Button 1 - RGB	LED status			1 bit	C	-	W	T	U	switch	Low

RGB lighting

Number	Name	Object Function	Descr	Group #	Length	C	R	W	T	U	Data Type	Priority
142	Button 1 - RGBW	Switch			1 bit	C	-	W	T	U	switch	Low
143	Button 1 - RGBW	RGBW dimming value			6 bytes	C	-	-	T	-	RGBW value 4x(0..100%)	Low
143	Button 1 - RGBW	Red dimming value			1 byte	C	-	-	T	-	percentage (0..100%)	Low
144	Button 1 - RGBW	Green dimming value			1 byte	C	-	-	T	-	percentage (0..100%)	Low
145	Button 1 - RGBW	Blue dimming value			1 byte	C	-	-	T	-	percentage (0..100%)	Low
146	Button 1 - RGBW	White dimming value			1 byte	C	-	-	T	-	percentage (0..100%)	Low
147	Button 1 - RGBW	Disable			1 bit	C	-	W	-	-	enable	Low
148	Button 1 - RGBW	LED status			1 bit	C	-	W	T	U	switch	Low

RGBW lighting

Number	Name	Object Function	Descr	Group #	Length	C	R	W	T	U	Data Type	Priority
142	Button 1 - Colour temperature	Switch			1 bit	C	-	W	T	U	switch	Low
143	Button 1 - Colour temperature	Brightness value			1 byte	C	-	-	T	-	percentage (0..100%)	Low
144	Button 1 - Colour temperature	Colour temperature value			2 bytes	C	-	-	T	-	absolute colour temperature (K)	Low
147	Button 1 - Colour temperature	Disable			1 bit	C	-	W	-	-	enable	Low
148	Button 1 - Colour temperature	LED status			1 bit	C	-	W	T	U	switch	Low

Colour temperature control

Number	Name	Object Function	Descr	Group #	Length	C	R	W	T	U	Data Type	Priority
142	Button 1 - Value sender	Short, 1bit value			1 bit	C	-	-	T	-	switch	Low
143	Button 1 - Value sender	Long, 1bit value			1 bit	C	-	-	T	-	switch	Low
142	Button 1 - Value sender	Short, 2bit value			2 bit	C	-	-	T	-	switch control	Low
143	Button 1 - Value sender	Long, 2bit value			2 bit	C	-	-	T	-	switch control	Low
142	Button 1 - Value sender	Short, 4bit value			4 bit	C	-	-	T	-	dimming control	Low
143	Button 1 - Value sender	Long, 4bit value			4 bit	C	-	-	T	-	dimming control	Low
142	Button 1 - Value sender	Short, 1byte value			1 byte	C	-	-	T	-	counter pulses (0..255)	Low
143	Button 1 - Value sender	Long, 1byte value			1 byte	C	-	-	T	-	counter pulses (0..255)	Low
142	Button 1 - Value sender	Short, 2byte value			2 bytes	C	-	-	T	-	pulses	Low
143	Button 1 - Value sender	Long, 2byte value			2 bytes	C	-	-	T	-	pulses	Low
142	Button 1 - Value sender	Short, 2byte float value			2 bytes	C	-	-	T	-	2-byte float value	Low
143	Button 1 - Value sender	Long, 2byte float value			2 bytes	C	-	-	T	-	2-byte float value	Low

Value sender(1)

Number	Name	Object Function	Description	Group Address	Length	C	R	W	T	U	Data Type	Priority
142	Button 1 - Value sender	Short, 4byte value			4 bytes	C	-	-	T	-	counter pulses (unsig...	Low
143	Button 1 - Value sender	Long, 4byte value			4 bytes	C	-	-	T	-	counter pulses (unsig...	Low
142	Button 1 - Value sender	Short, 4byte float value			4 bytes	C	-	-	T	-	4-byte float value	Low
143	Button 1 - Value sender	Long, 4byte float value			4 bytes	C	-	-	T	-	4-byte float value	Low
Value sender(2)												
142	Button 1 - Scene	Scene			1 byte	C	-	-	T	-	scene control	Low
142	Button 1 - Scene	Short, Scene			1 byte	C	-	-	T	-	scene control	Low
143	Button 1 - Scene	Long, Scene			1 byte	C	-	-	T	-	scene control	Low
147	Button 1 - Scene	Disable			1 bit	C	-	W	-	-	enable	Low
148	Button 1 - Scene	LED status			1 bit	C	-	W	T	U	switch	Low
Scene												
142	Button 1 - Blind	Up/Down, Blind			1 bit	C	-	W	T	-	up/down	Low
143	Button 1 - Blind	Stop/Adjust, Blind			1 bit	C	-	W	T	-	step	Low
147	Button 1 - Blind	Disable			1 bit	C	-	W	-	-	enable	Low
148	Button 1 - Blind	LED status			1 bit	C	-	W	T	U	switch	Low
Blind												
142	Button 1 - Shift register	Register value			1 byte	C	-	W	T	-	counter pulses (0..255)	Low
968	Btn 1 - Shift register	Disable			1 bit	C	-	W	-	-	enable	Low
969	Btn 1 - Shift register	LED status			1 bit	C	-	W	T	U	switch	Low
Shift register												
142	Button 1 - Multiple operation	Object1-On/Off			1 bit	C	-	W	T	-	switch	Low
142	Button 1 - Multiple operation	Object1-Up/Down			1 bit	C	-	W	T	-	up/down	Low
142	Button 1 - Multiple operation	Object1-SceneControl			1 byte	C	-	-	T	-	scene control	Low
142	Button 1 - Multiple operation	Object1-Percentage			1 byte	C	-	-	T	-	percentage (0..100%)	Low
142	Button 1 - Multiple operation	Object1-Unsigned value			1 byte	C	-	-	T	-	counter pulses (0..255)	Low
147	Button 1 - Multiple operation	Disable			1 bit	C	-	W	-	-	enable	Low
148	Button 1 - Multiple operation	LED status			1 bit	C	-	W	T	U	switch	Low
Multiple operation												
142	Button 1 - Delay mode	Short, Delay mode			1 bit	C	-	-	T	-	switch	Low
143	Button 1 - Delay mode	Long, Delay mode			1 bit	C	-	-	T	-	switch	Low
142	Button 1 - Delay mode	Short, Delay mode			4 bit	C	-	-	T	-	dimming control	Low
143	Button 1 - Delay mode	Long, Delay mode			4 bit	C	-	-	T	-	dimming control	Low
142	Button 1 - Delay mode	Short, Delay mode			1 byte	C	-	-	T	-	counter pulses (0..255)	Low
143	Button 1 - Delay mode	Long, Delay mode			1 byte	C	-	-	T	-	counter pulses (0..255)	Low
147	Button 1 - Delay mode	Disable			1 bit	C	-	W	-	-	enable	Low
148	Button 1 - Delay mode	LED status			1 bit	C	-	W	T	U	switch	Low
Delay mode												

Fig.6.3 "Button" communication object

NO.	Object Function	Name	Data Type	Flag	DPT
142	Switch	Button 1 - {...}	1bit	C,W,T,U	1.001 switch
142	Press/Short, Switch	Button 1 - {...}	1bit	C,W,T,U	1.001 switch
143	Release/Long, Switch	Button 1 - {...}	1bit	C,W,T,U	1.001 switch

These communication objects are used to trigger a switching operation. Use a common object or two separate objects is according to the parameter setting when press/release and long/short operation.

Only the object "Switch" is visible when use a common object. If use two separate objects, "Press/Release" is visible when there is no distinction for short/long operation; "Short/Long" is visible when there is distinction for short/long operation. Telegrams:

0—Off

1—On

The name in parentheses changes with the parameter "Description (max 30char.)". If description is empty, display "Button 1 - ..." by default. The same below.

142	Short, Switch	Button 1 - {...}	1bit	C,W,T,U	1.001 switch
143	Long, Dimming	Button 1 - {...}	4bit	C,W,T	3.007 dimming

These two communication objects are used to switch/dimming operation, with distinction for long/short operation.

Obj.142: Used to trigger switch operation. Telegrams:

0—Off

1—On

Obj.143: Used to trigger a relative dimming operation.

Dimming down when telegram is 1~7, and the larger this range the adjust step is smaller. That is, the maximum step of dimming down when is 1, and the minimum step of dimming down when is 7, stop dimming when is 0;

Dimming up when telegram is 9~15, and the larger this range the adjust step is smaller. That is, the maximum step of dimming up when is 9, and the minimum step of dimming up when is 15, stop dimming when is 8.

142	Switch	Button 1 - {...}	1bit	C,W,T,U	1.001 switch
143	RGB dimming value	Button 1 - {...}	3byte	C,T	232.600 RGB value 3x(0..255)
143	Red dimming value	Button 1 - {...}	1byte	C,T	5.001 percentage(0..100%)
144	Green dimming value	Button 1 - {...}	1byte	C,T	5.001 percentage(0..100%)
145	Blue dimming value	Button 1 - {...}	1byte	C,T	5.001 percentage(0..100%)

Obj.142: Used to trigger switch operation. Telegrams:

0—Off

1—On

Obj.143: The communication object is visible when 1x3byte for the RGB object type is selected. Apply to control brightness of multi-colour lamp, used for sending brightness value of RGB three-colour lamp to the bus.

3-Byte Code for RGB Dimming Object Data Type: U8 U8 U8, as follows:

3 _{MSB}	2	1 _{LSB}
R	G	B
UUUUUUUU	UUUUUUUU	UUUUUUUU

R: red dimming value; G: green dimming value; B: blue dimming value.

Obj.143, Obj.144, Obj.145: These three communication objects are visible when 3x1byte for the RGB object type is selected. Apply to control brightness of multi-colour lamp, used for sending brightness value of the control R(red) /G(green) / B (blue) channel to the bus. Telegrams: 0...100%

142	Switch	Button 1 - {...}	1bit	C,W,T,U	1.001 switch
143	RGBW dimming value	Button 1 - {...}	6byte	C,T	251.600 DPT_Colour_RGBW
143	Red dimming value	Button 1 - {...}	1byte	C,T	5.001 percentage(0..100%)
144	Green dimming value	Button 1 - {...}	1byte	C,T	5.001 percentage(0..100%)
145	Blue dimming value	Button 1 - {...}	1byte	C,T	5.001 percentage(0..100%)
146	White dimming value	Button 1 - {...}	1byte	C,T	5.001 percentage(0..100%)

Obj.142: Used to trigger switch operation. Telegrams:

0—Off

1—On

Obj.143: The communication object is visible when 1x6byte for the RGBW object type is selected. Apply to control brightness of multi-colour lamp, used for sending brightness value of RGBW four-colour lamp to the bus.

6 _{MSB}	5	4	3	2	1 _{LSB}
R	G	B	W	Reserve	r r r r mR mG mB mW
UUUUUUUU	UUUUUUUU	UUUUUUUU	UUUUUUUU	00000000	0000BBBB

R: red dimming value; G: green dimming value; B: blue dimming value; W: white dimming value;

mR: determines whether the red dimming value is valid, 0 = invalid, 1 = valid;

mG: determines whether the green dimming value is valid, 0 = invalid, 1 = valid;

mB: determines whether the blue dimming value is valid, 0 = invalid, 1 = valid;

mW: Determines whether the white dimming value is valid,0 = invalid,1 =valid.

Obj.143, Obj.144, Obj.145, Obj.146: These four communication objects are visible when 4x1byte for the RGBW object type is selected. Apply to control brightness of multi-colour lamp, used for sending brightness value of the control R(red) /G(green) / B (blue) / W(White) channel to the bus. Telegrams: 0...100%

142	Switch	Button 1 - {...}	1bit	C,W,T,U	1.001 switch
143	Brightness value	Button 1 - {...}	1byte	C,T	5.001 percentage(0..100%)
144	Colour temperature value	Button 1 - {...}	2byte	C,T	7.600 absolute colour temperature

Obj.142: Used to trigger switch operation. Telegrams:

0—Off

1—On

Obj.143: Used for sending the dimming telegram of the colour temperature to the bus, that is, sending the brightness value. Telegrams: 0...100%

Obj.144: Used for sending the control telegram of the colour temperature to the bus.

Telegrams: 1000...10000 K

142	Short, 1bit value	Button 1 - {...}		C,T	1.001 switch
	Short, 2bit value				2.001 switch control
	Short, 4bit value		1bit		3.007 dimming
	Short, 1byte value		2bit		5.010 counter pulses
	Short, 2byte value		4bit		7.001 pulses
	Short, 2byte float value		1byte		9.x float value
	Short, 4byte value		2byte		12.001 counter pulses
	Short, 4byte float value				14.x float value

143	Long, 1bit value	Button 1 - {...}	1bit	C,T	1.001 switch
	Long, 2bit value				2.001 switch control
	Long, 4bit value				3.007 dimming
	Long, 1byte value				5.010 counter pulses
	Long, 2byte value				7.001 pulses
	Short, 2byte float value				9.x float value
	Short, 4byte value				12.001 counter pulses
	Short, 4byte float value				14.x float value

These two communication objects are used for sending a fixed value to the bus, distinguish long and short operation. Range of values that can be sent are determined by the datatype, and the datatype is determined by the parameter setting.

142	Scene	Button 1 - {...}	1byte	C,T	18.001 scene control
142	Short, Scene	Button 1 - {...}	1byte	C,T	18.001 scene control
143	Long, Scene	Button 1 - {...}	1byte	C,T	18.001 scene control

These communication objects are used to send a 8 bit command to recall or storage scene. Use a common object or two separate objects is according to the parameter setting when long and short operation.

Only the object "Scene" is visible when use a common object. If use two separate objects, "Short/Long" is visible when there is distinction for short/long operation. Telegrams:

Detailed 8bit the meaning of the directive.

Set up a 8bit Orders for the (Binary code): FXNNNNNN

F: '0' recall scene; '1' for storage scene;

X : 0 ;

NNNNNN: Scene number(0... 63).

As follows:

Object message value	Description
0	Recall scene 1
1	Recall scene 2
2	Recall scene 3
...	...
63	Recall scene 64
128	Store scene 1
129	Store scene 2
130	Store scene 3
...	...
191	Store scene 64

Parameter setting Options are 1~64, actually communication object "Scene" corresponds to the telegram received is 0~63 . Such as parameter settings is the scene 1, communication object "Scene" sends the scene for 0.

142	Up/Down, Blind	Button 1 - {...}	1bit	C,W,T	1.008 up/down
143	Stop/Adjust, Blind	Button 1 - {...}	1bit	C,W,T	1.007 step

This two communication objects are used to control the blind up/down, stop:

Obj.142: Used for sending the telegram to the bus, to control blind up/down. Telegrams:

1—Move down

0—Move up

Obj.143: Used for sending the telegram to the bus, to stop curtain movement. Telegrams:

1—Stop

142	Register value	Button 1 - {...}	1byte	C,W,T	5.010 counter pulses 17.001 scene number 20.102 HVAC mode
-----	----------------	------------------	-------	-------	-----------------------------------------------------------------

The communication object is used to send the value of shift register.

142	Object1-On/Off	Button 1 - {...}	1bit	C,W,T	1.001 switch
	Object1-Up/Down		1bit	C,W,T	1.008 up/down
	Object1-SceneControl		1byte	C,T	18.001 scene control
	Object1-Percentage		1byte	C,T	5.001 percentage(0..100%)
	Object1-Unsigned value		1byte	C,T	5.010 counter pulses

<p>The communication object is object of multiple operation, up to activate 4 objects at the same time, and operation once can send the value of 4 different datatype objects to the bus via these objects. Range of values that can be sent are determined by the datatype, and the datatype is determined by the parameter setting.</p>					
142	Short, Delay mode	Button 1 - {...}	1bit 4bit 1byte	C,T	1.001 switch 3.007 dimming 5.010 counter pulses
143	Long, Delay mode	Button 1 - {...}	1bit 4bit 1byte	C,T	1.001 switch 3.007 dimming 5.010 counter pulses
<p>These communication objects are used to send the value of delay mode to the bus, distinguish long and short operation. Range of values that can be sent are determined by the datatype, and the datatype is determined by the parameter setting.</p>					
147	Disable	Button 1 - {...}	1bit	C,W	1.003 enable
<p>The communication object is used to disable/enable the function of contact input, apply to all the above functions.</p>					
148	LED status	Button 1 - {...}	1bit 1byte	C,W,T,U	1.001 switch 5.010 counter pulses
<p>The communication object is used to control LED status via the bus, and also can receive status feedback. Range of values that can be sent are determined by the datatype, and the datatype is determined by the parameter setting.</p>					

Table 6.4 "Button" communication object table

6.4. “Logic” Communication Object

6.4.1. “AND/OR/XOR” Communication Object

Number	Name	Object Function	Descr	Group A	Length	C	R	W	T	U	Data Type	Priority
5	1st Logic	Input a			1 bit	C	-	W	T	U	boolean	Low
6	1st Logic	Input b			1 bit	C	-	W	T	U	boolean	Low
7	1st Logic	Input c			1 bit	C	-	W	T	U	boolean	Low
8	1st Logic	Input d			1 bit	C	-	W	T	U	boolean	Low
9	1st Logic	Input e			1 bit	C	-	W	T	U	boolean	Low
10	1st Logic	Input f			1 bit	C	-	W	T	U	boolean	Low
11	1st Logic	Input g			1 bit	C	-	W	T	U	boolean	Low
12	1st Logic	Input h			1 bit	C	-	W	T	U	boolean	Low
13	1st Logic	Logic result			1 bit	C	-	-	T	-	boolean	Low

Fig.6.4.1 “AND/OR/XOR” communication object

NO.	Object Function	Name	Data Type	Flag	DPT
5/...	Input x	{{1st Logic}}	1bit	C,W,T,U	1.002 boolean
<p>The communication object is used to receive the value of logical input Input x.</p> <p>The name in parentheses changes with the parameter “Description for logic function”. If description is empty, display “1st Logic” by default. The same below.</p>					
13	Logic result	{{1st Logic}}	1bit	C,T	1.002 boolean
<p>The communication object is used to send the results of logical operation.</p>					

Table 6.4.1 “AND/OR/XOR” communication object table

6.4.2. “Gate forwarding” Communication Object

Number	Name	Object Function	Descr	Group A	Length	C	R	W	T	U	Data Type	Priority
5	1st Logic	Gate value select			1 byte	C	-	W	-	-	scene number	Low
6	1st Logic	Input A			1 bit	C	-	W	-	-	switch	Low
7	1st Logic	Input B			1 bit	C	-	W	-	-	switch	Low
8	1st Logic	Input C			1 bit	C	-	W	-	-	switch	Low
9	1st Logic	Input D			1 bit	C	-	W	-	-	switch	Low
10	1st Logic	Output A			1 bit	C	-	-	T	-	switch	Low
11	1st Logic	Output B			1 bit	C	-	-	T	-	switch	Low
12	1st Logic	Output C			1 bit	C	-	-	T	-	switch	Low
13	1st Logic	Output D			1 bit	C	-	-	T	-	switch	Low

Fig.6.4.2 “Gate forwarding” communication object

NO.	Object Function	Name	Data Type	Flag	DPT
5	Gate value select	{{1st Logic}}	1byte	C,W	17.001 scene number
<p>The communication object is used to select the scene of logical gate forwarding.</p>					

6/.../9	Input x	{{1st Logic}}	1bit 4bit 1byte	C,W	1.001 switch 3.007 dimming control 5.010 counter pulses(0..255)
The communication object is used to receive the value of the logic gate input Input x.					
10/.../13	Output x	{{1st Logic}}	1bit 4bit 1byte	C,T	1.001 switch 3.007 dimming control 5.010 counter pulses(0..255)
The communication object is used to output the value forwarded by the logic gate. The output value is the same as the input value, but one input can be forwarded into one or more outputs, set by parameters.					

Table 6.4.2 "Gate forwarding" communication object table

6.4.3. "Threshold comparator" Communication Object

Number	Name	Object Function	Descr	Group	Length	C	R	W	T	U	Data Type	Priority
5	1st Logic	Threshold value input			4 bit	C	-	W	-	U	dimming control	Low
5	1st Logic	Threshold value input			1 byte	C	-	W	-	U	counter pulses (0..255)	Low
5	1st Logic	Threshold value input			2 bytes	C	-	W	-	U	pulses	Low
5	1st Logic	Threshold value input			2 bytes	C	-	W	-	U	2-byte signed value	Low
5	1st Logic	Threshold value input			2 bytes	C	-	W	-	U	2-byte float value	Low
5	1st Logic	Threshold value input			4 bytes	C	-	W	-	U	counter pulses (unsigned)	Low
5	1st Logic	Threshold value input			2 bytes	C	-	W	-	U	temperature (°C)	Low
5	1st Logic	Threshold value input			2 bytes	C	-	W	-	U	lux (Lux)	Low
13	1st Logic	Logic result			1 bit	C	-	-	T	-	boolean	Low

Fig.6.4.3 "Threshold comparator" communication object

NO.	Object Function	Name	Data Type	Flag	DPT
5	Threshold value input	{{1st Logic}}	4bit 1byte 2byte 4byte	C,W, U	3.007 dimming 5.010 counter pulses 7.001 pulses 12.001 counter pulses 8.x signed value 9.x float value 9.001 temperature 9.007 humidity 9.004 lux
The communication object is used to input threshold value.					

13	Logic result	{{1st Logic}}	1bit	C,T	1.002 boolean
<p>The communication object is used to send the results of logical operation. That is, the value that should be sent after the object input threshold is compared with the setting threshold value.</p>					

Table 6.4.3 “Threshold comparator” communication object table

6.4.4. “Format convert” Communication Object

Number	Name	Object Function	Descr	Group	Length	C	R	W	T	U	Data Type	Priority
5	1st Logic	Input 1bit-bit0			1 bit	C	-	W	-	U	boolean	Low
6	1st Logic	Input 1bit-bit1			1 bit	C	-	W	-	U	boolean	Low
13	1st Logic	Output 2bit			2 bit	C	-	-	T	-	switch control	Low

“2x1bit --> 1x2bit”function: converts two 1bit values to a 2bit value, such as Input bit1=1, bit0=0-->

Output 2bit=2

Number	Name	Object Function	Descr	Group	Length	C	R	W	T	U	Data Type	Priority
5	1st Logic	Input 1bit-bit0			1 bit	C	-	W	-	U	boolean	Low
6	1st Logic	Input 1bit-bit1			1 bit	C	-	W	-	U	boolean	Low
7	1st Logic	Input 1bit-bit2			1 bit	C	-	W	-	U	boolean	Low
8	1st Logic	Input 1bit-bit3			1 bit	C	-	W	-	U	boolean	Low
9	1st Logic	Input 1bit-bit4			1 bit	C	-	W	-	U	boolean	Low
10	1st Logic	Input 1bit-bit5			1 bit	C	-	W	-	U	boolean	Low
11	1st Logic	Input 1bit-bit6			1 bit	C	-	W	-	U	boolean	Low
12	1st Logic	Input 1bit-bit7			1 bit	C	-	W	-	U	boolean	Low
13	1st Logic	Output 1byte			1 byte	C	-	-	T	-	counter pulses (0..255)	Low

“8x1bit --> 1x1byte”function: converts eight 1bit values to a 1byte value, such as Input bit2=1, bit1=1, bit0=1,other bits are 0--> Output 1byte=7

Number	Name	Object Function	Descr	Group	Length	C	R	W	T	U	Data Type	Priority
5	1st Logic	Input 1byte			1 byte	C	-	W	-	U	counter pulses (0..255)	Low
13	1st Logic	Output 2byte			2 bytes	C	-	-	T	-	pulses	Low

“1x1byte --> 1x2byte”function: converts one 1byte values to a 2byte value, such as Input 1byte=125--> Output 2byte=125.Although the value remains the same, the data type of the value is different.

Number	Name	Object Function	Descr	Group	Length	C	R	W	T	U	Data Type	Priority
5	1st Logic	Input 1byte			1 byte	C	-	W	-	U	counter pulses (0..255)	Low
13	1st Logic	Output 2byte			2 bytes	C	-	-	T	-	pulses	Low

“2x1byte --> 1x2byte”function: converts two 1byte values to a 2byte value, such as Input 1byte-low = 255 (\$FF), Input 1byte-high = 100 (\$64) --> Output 2byte = 25855 (\$64 FF)

Number	Name	Object Function	Descr	Group A	Length	C	R	W	T	U	Data Type	Priority
5	1st Logic	Input 2byte-low			2 bytes	C	-	W	-	U	pulses	Low
6	1st Logic	Input 2byte-high			2 bytes	C	-	W	-	U	pulses	Low
13	1st Logic	Output 4byte			4 bytes	C	-	-	T	-	counter pulses (unsigned)	Low

“2x2byte -> 1x4byte”function: converts two 2 byte values to a 4byte value, such as Input 2byte-low = 65530 (\$FF FA), Input 2byte-high = 32768 (\$80 00)--> Output 2byte = 2147549178 (\$80 00 FF FA)

Number	Name	Object Function	Descr	Group A	Length	C	R	W	T	U	Data Type	Priority
5	1st Logic	Input 1byte			1 byte	C	-	W	-	U	counter pulses (0..255)	Low
6	1st Logic	Output 1bit-bit0			1 bit	C	-	-	T	-	boolean	Low
7	1st Logic	Output 1bit-bit1			1 bit	C	-	-	T	-	boolean	Low
8	1st Logic	Output 1bit-bit2			1 bit	C	-	-	T	-	boolean	Low
9	1st Logic	Output 1bit-bit3			1 bit	C	-	-	T	-	boolean	Low
10	1st Logic	Output 1bit-bit4			1 bit	C	-	-	T	-	boolean	Low
11	1st Logic	Output 1bit-bit5			1 bit	C	-	-	T	-	boolean	Low
12	1st Logic	Output 1bit-bit6			1 bit	C	-	-	T	-	boolean	Low
13	1st Logic	Output 1bit-bit7			1 bit	C	-	-	T	-	boolean	Low

“1x1byte -> 8x1bit” function: converts one 1byte values to eight 1bit value, such as Input 1byte=200 -> Output bit0=0, bit1=0, bit2=0, bit3=1, bit4=0, bit5=0, bit6=1, bit7=1

Number	Name	Object Function	Descr	Group A	Length	C	R	W	T	U	Data Type	Priority
5	1st Logic	Input 2byte			2 bytes	C	-	W	-	U	pulses	Low
12	1st Logic	Output 1byte-low			1 byte	C	-	-	T	-	counter pulses (0..255)	Low
13	1st Logic	Output 1byte-high			1 byte	C	-	-	T	-	counter pulses (0..255)	Low

“1x2byte -> 2x1byte”function: converts one 2byte values to two 1byte value, such as Input 2byte = 55500 (\$D8 CC) -> Output 1byte-low = 204 (\$CC), Output 1byte-high =216 (\$D8)

Number	Name	Object Function	Descr	Group A	Length	C	R	W	T	U	Data Type	Priority
5	1st Logic	Input 4byte			4 bytes	C	-	W	-	U	counter pulses (unsigned)	Low
12	1st Logic	Output 2byte-low			2 bytes	C	-	-	T	-	pulses	Low
13	1st Logic	Output 2byte-high			2 bytes	C	-	-	T	-	pulses	Low

“1x4byte -> 2x2byte”function: converts one 4byte values to two 2byte value, such as Input 4byte = 78009500 (\$04 A6 54 9C) -> Output 2byte-low = 21660 (\$54 9C), Output 2byte-high =1190 (\$04 A6)

Number	Name	Object Function	Descr	Group A	Length	C	R	W	T	U	Data Type	Priority
5	1st Logic	Input 3byte			3 bytes	C	-	W	-	U	RGB value 3x(0..255)	Low
11	1st Logic	Output 1byte-low			1 byte	C	-	-	T	-	counter pulses (0..255)	Low
12	1st Logic	Output 1byte-middle			1 byte	C	-	-	T	-	counter pulses (0..255)	Low
13	1st Logic	Output 1byte-high			1 byte	C	-	-	T	-	counter pulses (0..255)	Low

“1x3byte -> 3x1byte”function: converts one 3byte values to three 1byte value, such as Input 3byte = \$78 64 C8--> Output 1byte-low = 200 (\$C8) , Output 1byte-middle = 100 (\$64) , Output 1byte-high =120 (\$78)

Number	Name	Object Function	Descr	Group A	Length	C	R	W	T	U	Data Type	Priority
5	1st Logic	Input 1byte-low			1 byte	C	-	W	-	U	counter pulses (0..255)	Low
6	1st Logic	Input 1byte-middle			1 byte	C	-	W	-	U	counter pulses (0..255)	Low
7	1st Logic	Input 1byte-high			1 byte	C	-	W	-	U	counter pulses (0..255)	Low
13	1st Logic	Output 3byte			3 bytes	C	-	-	T	-	RGB value 3x(0..255)	Low

“3x1byte -> 1x3byte”function: converts three 1byte values to a 3byte value, such as Input 1byte-low = 150 (\$96), Input 1byte-middle = 100 (\$64), Input 1byte-high = 50 (\$32)--> Output 3byte = \$32 64 96

Fig.6.4.4 “Format convert” communication object

NO.	Object Function	Name	Data Type	Flag	DPT
5	Input ...	{{1st Logic}}	1bit	C,W,U	1.001 switch
			1byte		5.010 counter pulses(0..255)
			2byte		7.001 pulses
			3byte		232.600 RGB value 3x(0..255)
			4byte		12.001 counter pulses
The communication object is used to input a value that needs to be converted.					
13	Output ...	{{1st Logic}}	1bit	C,T	1.001 switch
			2bit		2.001 switch control
			1byte		5.010 counter pulses(0..255)
			2byte		7.001 pulses
			3byte		232.600 RGB value 3x(0..255)
4byte	12.001 counter pulses				
The communication object is used to output the converted value.					

Table 6.4.4 "Format convert" communication object table

6.4.5. "Gate function" Communication Object

Number	Name	Object Function	Descr	Group	Length	C	R	W	T	U	Data Type	Priority
5	1st Logic	Input			1 bit	C	-	W	-	-	switch	Low
6	1st Logic	Gate input			1 bit	C	-	W	-	-	boolean	Low
13	1st Logic	Output			1 bit	C	-	-	T	-	switch	Low
Input/Output - 1bit[On/Off]												
Number	Name	Object Function	Descr	Group	Length	C	R	W	T	U	Data Type	Priority
5	1st Logic	Input			1 byte	C	-	W	-	-	percentage (0..100%)	Low
6	1st Logic	Gate input			1 bit	C	-	W	-	-	boolean	Low
13	1st Logic	Output			1 byte	C	-	-	T	-	percentage (0..100%)	Low
Input/Output - 1byte[0..100%]												
Number	Name	Object Function	Descr	Group	Length	C	R	W	T	U	Data Type	Priority
5	1st Logic	Input			1 byte	C	-	W	-	-	counter pulses (0..255)	Low
6	1st Logic	Gate input			1 bit	C	-	W	-	-	boolean	Low
13	1st Logic	Output			1 byte	C	-	-	T	-	counter pulses (0..255)	Low
Input/Output - 1byte[0..255]												
Number	Name	Object Function	Descr	Group	Length	C	R	W	T	U	Data Type	Priority
5	1st Logic	Input			2 bytes	C	-	W	-	-	temperature (°C)	Low
6	1st Logic	Gate input			1 bit	C	-	W	-	-	boolean	Low
13	1st Logic	Output			2 bytes	C	-	-	T	-	temperature (°C)	Low
Input/Output - 2byte[Float]												
Number	Name	Object Function	Descr	Group	Length	C	R	W	T	U	Data Type	Priority
5	1st Logic	Input			2 bytes	C	-	W	-	-	pulses	Low
6	1st Logic	Gate input			1 bit	C	-	W	-	-	boolean	Low
13	1st Logic	Output			2 bytes	C	-	-	T	-	pulses	Low
Input/Output - 2byte[0..65535]												

Fig.6.4.5 "Gate function" communication object

NO.	Object Function	Name	Data Type	Flag	DPT
5	Input	{{1st Logic}}	1bit	C,W	1.001 switch
			1byte		5.001 percentage
			2byte		5.010 counter pulses
					9.001 temperature
					7.001 pulses
The communication object is used to input a value that needs to gate filter.					
6	Gate input	{{1st Logic}}	1bit	C,W	1.002 boolean
The communication object is used to control the switch status of gate input. Input signal is allowed to pass when gate open, then output, and the current input status is still sent if there is a change; Can not pass when gate close.					
13	Output	{{1st Logic}}	bit	C,T	1.001 switch
			1byte		5.001 percentage
			2byte		5.010 counter pulses
					9.001 temperature
					7.001 pulses
The communication object is used to output the value after gate filtering. Only when gate input status is open, output is available, defined by the object "Gate input".					

Table 6.4.5 "Gate function" communication object table

6.4.6. "Delay function" Communication Object

Number	Name	Object Function	Descr	Group	Length	C	R	W	T	U	Data Type	Priority
5	1st Logic	Input			1 bit	C	-	W	-	-	switch	Low
13	1st Logic	Output			1 bit	C	-	-	T	-	switch	Low
Input/Output - 1bit[On/Off]												
5	1st Logic	Input			1 byte	C	-	W	-	-	percentage (0..100%)	Low
13	1st Logic	Output			1 byte	C	-	-	T	-	percentage (0..100%)	Low
Input/Output - 1byte[0..100%]												
5	1st Logic	Input			1 byte	C	-	W	-	-	counter pulses (0..255)	Low
13	1st Logic	Output			1 byte	C	-	-	T	-	counter pulses (0..255)	Low
Input/Output - 1byte[0..255]												
5	1st Logic	Input			2 bytes	C	-	W	-	-	temperature (°C)	Low
13	1st Logic	Output			2 bytes	C	-	-	T	-	temperature (°C)	Low
Input/Output - 2byte[Float]												
5	1st Logic	Input			2 bytes	C	-	W	-	-	pulses	Low
13	1st Logic	Output			2 bytes	C	-	-	T	-	pulses	Low
Input/Output - 2byte[0..65535]												

Fig.6.4.6 "Delay function" communication object

NO.	Object Function	Name	Data Type	Flag	DPT
5	Input	{{1st Logic}}	1bit 1byte 2byte	C,W	1.001 switch 5.001 percentage 5.010 counter pulses 9.001 temperature 7.001 pulses
The communication object is used to input a value that needs to delay.					
13	Output	{{1st Logic}}	1bit 1byte 2byte	C,T	1.001 switch 5.001 percentage 5.010 counter pulses 9.001 temperature 7.001 pulses
The communication object is used to output that needs to delay converted value, delay time is defined by the parameter.					

Table 6.4.6 "Delay function" communication object table

6.4.7. "Staircase lighting" Communication Object

Number	Name	Object Function	Descr	Group	Length	C	R	W	T	U	Data Type	Priority
5	1st Logic	Trigger value			1 bit	C	-	W	-	-	trigger	Low
6	1st Logic	Light-on duration time			2 bytes	C	-	W	-	-	time (s)	Low
13	1st Logic	Output			1 bit	C	-	-	T	-	switch	Low
13	1st Logic	Output			1 byte	C	-	-	T	-	counter pulses (0..255)	Low

Fig.6.4.7 "Staircase lighting" communication object

NO.	Object Function	Name	Data Type	Flag	DPT
5	Trigger value	{{1st Logic}}	1bit	C,W	1.017 trigger
The communication object is used to receive the value to trigger staircase lighting.					
6	Light-on duration time	{{1st Logic}}	2byte	C,W	7.005 time(s)
The communication object is used to modify the staircase light-on duration time, the modified range is referenced from the range defined by the parameter, take the limit value if exceeded.					
13	Output	{{1st Logic}}	1bit 1byte	C,T	1.001 switch 5.010 counter pulses
The communication object is used to output value 1 when trigger, and send value 2 after duration time. Telegram value is determined by the parameter setting datatype.					

Table 6.4.7 "Staircase lighting" communication object table

6.5. "Scene Group" Communication Object

Number	Name	Object Function	Description	Group Address	Length	C	R	W	T	U	Data Type	Priority
77	Scene Group	Main scene trigger			1 byte	C	-	W	-	-	scene num...	Low
78	1st Scene Group-Output 1	1bit value			1 bit	C	-	-	T	-	switch	Low
79	1st Scene Group-Output 2	1bit value			1 bit	C	-	-	T	-	switch	Low
80	1st Scene Group-Output 3	1bit value			1 bit	C	-	-	T	-	switch	Low
81	1st Scene Group-Output 4	1bit value			1 bit	C	-	-	T	-	switch	Low
82	1st Scene Group-Output 5	1bit value			1 bit	C	-	-	T	-	switch	Low
83	1st Scene Group-Output 6	1bit value			1 bit	C	-	-	T	-	switch	Low
84	1st Scene Group-Output 7	1bit value			1 bit	C	-	-	T	-	switch	Low
85	1st Scene Group-Output 8	1bit value			1 bit	C	-	-	T	-	switch	Low











Fig.6.5 "Scene Group" communication object











NO.	Object Function	Name	Data Type	Flag	DPT
77	Main scene trigger	Scene Group	1byte	C,W	17.001 scene number
<p>This communication object triggers each output in the scene group to send a specific value to the bus by recalling the scene number. Telegrams: 0.. 63</p>					
78/..	1bit value 1byte unsigned value HVAC mode 2byte unsigned value Temperature	1st Scene Group-{{Output x}}	1bit 1byte 2byte	C,T	1.001 switch 5.010 counter pulses 20.102 HVAC mode 7.001 pulses 9.001 temperature
<p>When a scene is recalled, the communication object is used to send the corresponding output value of the scene to the bus. If the output is not set to this scene, it will not be sent.</p> <p>A total of 8 scene groups can be set up, with 8 outputs per group.</p> <p>The name in parentheses changes with the parameter "Description for logic function". If description is empty, display "1st Scene Group-Output x" by default. The same below.</p>					























Table 6.5 "Scene Group" communication object table



















Chapter 7 Icon list

7.1.Device icon









ETS options	Icon
General light	
Ceiling light 1	
Ceiling light 2	
Downlight 1	
Downlight 2	
Wall light	
Spotlight	
Chandelier 1	
Chandelier 2	
Floor light	

ETS options	Icon
LED strip	
RGB light	
Curtain	
Roller blind	
Venetian blind	
TV	
Audio	
Socket(CHN)	
Socket(EU)	
Fan	











Lock 1		VESDA	
Lock 2		FIRE	
Power 1		Water Sensor	
Power 2		Gas Sensors	
Window 1		Sensor 1	
Window 2		Sensor 2	
Alarm		Temperature 1	
Projector		Temperature 2	
Multimedia		Humidity	
Presence		PM2.5	
Infrared Sensor		PM10	
Door Sensor		CO2	

VOC		Air conditioner 3	
Brightness		Heating	
Wind speed		Cooling	
Rain		Heating/Cooling	
Energy		Music 1	
I/O signal		Music 2	
Electronic heating		Ventilation	
Water heating		AQI	
Air conditioner 1		Not Disturb	
Air conditioner 2			

7.2.Scene icon

ETS options	Icon
General scene 1	
General scene 2	
General scene 3	
General scene 4	
General scene 5	
All on	
All off	
Leave home 1	

ETS options	Icon
Go home 1	
Go home 2	
Leave home 2	
Welcome 1	
Welcome 2	
Dinner	
Party	
Sleeping	

Wake up		Security	
Reading		Conference	
Media		Relax	
Cleaning 1		Romantic 1	
Cleaning 2		Romantic 2	
Economy		Play	