

Product Manual

ise smart connect KNX Saunier Duval

Order No. S-0001-017

Complete set for installation, consisting of the two system components:

- ise smart connect KNX Saunier Duval and
- ise eBUS Adapter

Order No. 1-0006-018

- ise smart connect KNX Saunier Duval

Order No. 2-0001-003

- ise eBUS Adapter

Valid for application software version 2.0 and
firmware version 2.0

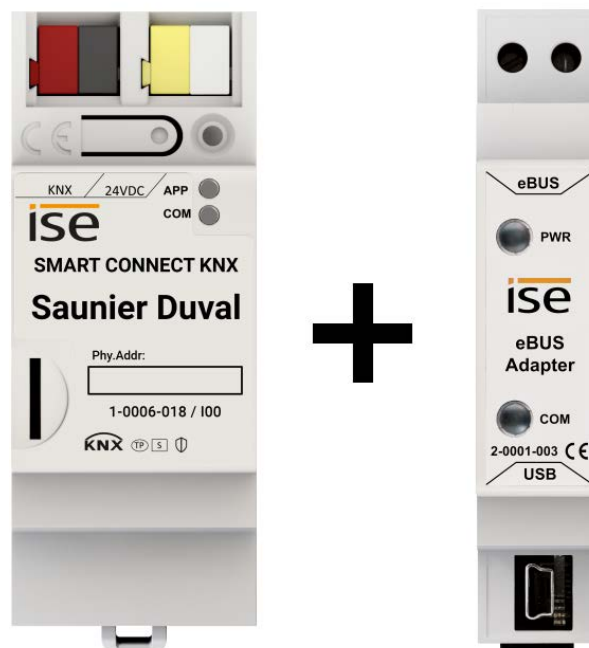

Contents

1	<u>Product description</u>	<u>4</u>
1.1	Functions	4
1.2	Saunier Duval goes KNX.....	5
1.3	Definitions and explanation of terms.....	5
1.4	Function schematic	6
1.5	Usage scenarios – Comfort solutions with KNX and Saunier Duval.....	7
1.5.1	Your presence controls the heating	7
1.5.2	Controlling hot water and heating as needed.....	7
1.5.3	Adjusting heating and hot water to special situations.....	7
1.6	Obtaining information from the Saunier Duval system	8
1.6.1	Preparing information on energy yield	8
1.6.2	Energy consumption at a glance.....	8
1.6.3	Display heating status	8
1.6.4	Heating active/inactive.....	8
1.6.5	Display water pressure	8
1.6.6	Informed in detail.....	8
2	<u>Installation, electrical connection and operation.....</u>	<u>9</u>
2.1	Device design ise smart connect KNX Saunier Duval.....	9
2.2	Safety notes	10
2.3	Installation and electrical connection	10
2.4	Device design ise eBUS Adapter.....	12
2.5	Connecting the ise eBUS Adapter to the eBUS	13
3	<u>Configuration.....</u>	<u>15</u>
3.1	Configuration step 1 – Create ise smart connect KNX Saunier Duval as device in the ETS ...	16
3.2	Configuration step 2 – Assigning an individual address.....	16
3.3	Configuration step 3 – Setting the IP address, subnet mask and address of the default gateway.....	16
3.4	Setting general parameters	18
3.4.1	System dimensioning parameters.....	18
3.4.2	Parameters use cases.....	21
3.4.3	Time settings.....	22
3.5	Connecting group addresses to group communication objects.....	23
4	<u>Commissioning</u>	<u>66</u>
4.1	Operation	66
4.2	LED status displays.....	67
4.2.1	LED status display upon device start-up.....	67
4.2.2	LED status display in operation	68
4.3	Accelerate transfer: Select transfer path <i>KNX-TP</i> or <i>IP</i>	69
4.4	Downloading the individual address of the device	69
4.5	Transferring application programs and configuration data	70
4.6	Factory reset	70
4.6.1	Factory reset using the programming button on the device.....	70
4.6.2	Factory reset using the website of the device	70
4.7	Firmware update of the device	71
4.7.1	Firmware update using the device website	71
4.7.2	Local firmware update without internet access	71

4.7.3	Compatibility of catalogue entry with firmware	71
5	<u>Technical data</u>	<u>72</u>
5.1	ise smart connect KNX Saunier Duval.....	72
5.2	ise eBUS Adapter.....	73
6	<u>Frequently asked questions (FAQ)</u>	<u>74</u>
7	<u>Troubleshooting and support.....</u>	<u>75</u>
7.1	Downloading log files if a problem occurs.....	75
7.2	Status page of the ise smart connect KNX Saunier Duval	75
7.3	The ise smart connect KNX Saunier Duval does not work.....	76
8	<u>ise smart connect KNX Saunier Duval software licence agreement.....</u>	<u>77</u>
8.1	Definitions	77
8.2	Object of the agreement.....	77
8.3	Rights of use of the ise smart connect KNX Saunier Duval software	77
8.4	Restriction of rights of use	77
8.4.1	Copying, modification and transmission.....	77
8.4.2	Reverse engineering and conversion technologies.....	77
8.4.3	Firmware and hardware.....	78
8.4.4	Transfer to a third party	78
8.4.5	Renting out, leasing out and sub-licensing	78
8.4.6	Software creation	78
8.4.7	The mechanisms of license management and copy protection.....	78
8.5	Ownership, confidentiality.....	78
8.5.1	Documentation	78
8.5.2	Transfer to a third party	78
8.6	Changes, additional deliveries.....	78
8.7	Warranty	78
8.7.1	Software and documentation	79
8.7.2	Limitation of warranty	79
8.8	Liability	79
8.9	Applicable law	79
8.10	Termination	79
8.11	Subsidiary agreements and changes to the agreement.....	80
8.12	Exception	80

1 Product description

1.1 Functions

- Operating a MiPro Sense-controlled Saunier Duval¹ heating and domestic hot water system using KNX².
- Control of heating including cooling function and hot water with the usual KNX operating devices – regardless of heating control unit.
- Easy connection of visualisation systems and facility management systems.
- Changes made using the heating system controller are reported on the KNX.
- Supports accelerated transmission from the ETS² to the ise smart connect KNX Saunier Duval via a direct IP connection.
- The ise smart connect KNX Saunier Duval is configured using the latest version of the ETS5. The application accesses ETS functions not supported by earlier ETS versions.
- Together with the ise eBUS Adapter, the ise smart connect KNX Saunier Duval establishes the connection between the smart heating control and your KNX system.

Important note:

The use of both system components is required to ensure functioning control. The ise smart connect KNX Saunier Duval can therefore only be used in conjunction with the ise eBUS Adapter.

The system components can be ordered as a set or individually (for replacement purposes). The Saunier Duval heating system must be controlled using the MiPro Sense system controller. Other system controllers are not compatible. The term system controller is used in the rest of this manual.

Important!

The device must be supplied with voltage by a dedicated power supply unit. Do not use the auxiliary voltage output of a KNX power supply unit which is also supplying a KNX line.

Important note:

The product comes with a handover protocol in German and English. The HVAC supplier must document installation on the handover protocol and hand it to the planner for building technology (KNX bus system). The handover protocol is available in other languages on the website at www.ise.de/en/home.

¹ Saunier Duval represents the Saunier Duval brand group with its brands Saunier Duval, AWB, Bulex, Glow-worm, Hermann Saunier Duval and Protherm.

² ETS and KNX are registered trademarks of KNX Association cvba

1.2 Saunier Duval goes KNX

The ise smart connect KNX Saunier Duval enables you to implement innovative solutions for your intelligent home.

Connecting KNX and Saunier Duval opens up new possibilities:

- Your presence and absence control the heating.
- Operating devices in every room desired enable convenient access to your Saunier Duval system.
- "Instant" hot water can be requested using a sensor or an operating device in the room in question.
- Integration of heating in building scenarios.

These and other application examples can be found in more detail in chapter 1.5 "Usage scenarios – Comfort solutions with KNX and Saunier Duval".

1.3 Definitions and explanation of terms

- **ise eBUS Adapter**

The ise eBUS Adapter is a system component used to connect the Saunier Duval bus modular control system with the KNX system.

The eBUS adapter connects

- ise smart connect series devices for the eBUS connection, in this case, ise smart connect KNX Saunier Duval, and
 - the Saunier Duval controller
- with one another via a USB interface.

The eBUS adapter is a specially designed system component for these specific use cases.

Any other use or use beyond this purpose is considered improper.

- **Saunier Duval system**

All components of the heating system of the Saunier Duval brand group are designated as the Saunier Duval system. One of these components must be a system controller with which the ise smart connect KNX Saunier Duval communicates. This can also be the radio module in the system controller.

Information on the operation, installation and any required accessories can be found in the corresponding documents issued by the Saunier Duval brand group.

- **eBUS**

The commands generated by KNX devices are prepared via the ise smart connect KNX Saunier Duval and the ise eBUS Adapter to enable communication with the central system controls the Saunier Duval system via the eBUS.

Separate addressing of ise system components for the eBUS is not necessary.

The eBUS connection point is described in chapter 2.5 "Connecting the ise eBUS Adapter to the eBUS".

The relevant instructions for installation on the eBUS provided by the Saunier Duval brand group (connection procedures, cable selection etc.) must be observed.

1.4 Function schematic



Control your heating system using KNX.
This enables you to access the control or call up entire scenarios from anywhere.

Room 1



Room 2



Room 3



KNX operation

KNX

eBUS

ise smart connect KNX
Saunier Duval

ise eBUS Adapter

LAN

USB

1.5 Usage scenarios – Comfort solutions with KNX and Saunier Duval

Enhance the existing Comfort functions of your KNX system and smart heating and domestic hot water control.

1.5.1 Your presence controls the heating

You won't be at home for a longer period of time. KNX enables you to perform an occupied-home simulation today, allowing you to conveniently activate the alarm system by pressing the "absence switch". You can now also use the ise smart connect KNX Saunier Duval to switch your heating system to "standby mode". This allows you to reduce the room temperature setpoint values in all rooms (if desired) and minimise heating.

1.5.2 Controlling hot water and heating as needed

You want to be able to enter and change the times and setpoint values for heating and hot water in your visualisation or any other operating device quickly and easily. This means you can save energy without renouncing comfort. After all, the system only works when you need it.

1.5.3 Adjusting heating and hot water to special situations

You want to be able to react to short-term changes in use quickly and easily (longer than usual periods of absence, events, parties, etc.). With the ise smart connect KNX Saunier Duval, you can temporarily change the times and setpoint values for heating and hot water. After this period, your standard values apply once again.

1.6 Obtaining information from the Saunier Duval system

1.6.1 Preparing information on energy yield

Prepare information on the energy yield of the heat pumps and/or solar system to create a clear overview of the energy generation on your visualisation. Note that this information must be provided by the components used in the heating system.

1.6.2 Energy consumption at a glance

Prepare information on the energy consumption to create a constant overview of consumption on your visualisation (or other display). Recognise changes and adapt the control to changed usage behaviour if necessary. Note that this information must be provided by the components used in the heating system.

1.6.3 Display heating status

Prepare information on your heating system to create a constant overview of the system on your visualisation. This enables you to react immediately in the event of a fault.

1.6.4 Heating active/inactive

Check whether the heating is currently active at any time via your visualisation.

1.6.5 Display water pressure

Receive an alarm signal for insufficient water pressure. Select the signalling in a manner and location that allows you to react quickly.

1.6.6 Informed in detail

Whether you are on the sofa or looking at the panel, you can read important data such as the hot water temperature, the circulation pump status or the minimum setpoint flow temperature for cooling mode quickly and clearly on your KNX visualisation display.

2 Installation, electrical connection and operation

2.1 Device design ise smart connect KNX Saunier Duval

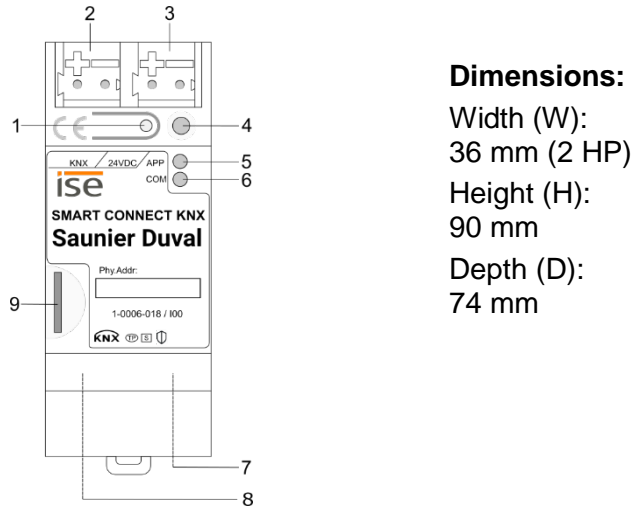

Figure 1: ise smart connect KNX Saunier Duval

1	Programming button for KNX	Switches the device to the ETS programming mode or vice versa.	
2	KNX connection (twisted pair)	Left: (+ / red) Right: (- / black)	
3	Connection for power supply	DC 24 to 30 V, 2 W (at 24 V) Left: (+ / yellow) Right: (- / white)	
4	KNX programming LED (red)	Red:	Device is in ETS programming mode
5	LED APP (green)	Green:	Normal operation Off / flashes: See 4.2.1 / 4.2.2 for start or diagnosis code
6	LED COM (yellow)	Yellow:	Normal operation (brief dark phases indicate KNX telegram traffic) Off / flashes: See 4.2.1 / 4.2.2 for start or diagnosis code
7	Ethernet connection	LED 10/100 speed (green) On: 100 Mbit/s Off: 10 Mbit/s	LED link/ACT (orange) On: Connection to IP network Off: No connection Flashes: Data reception on IP
8	USB connection	USB connection type A; establishes the connection to the Saunier Duval system via the ise eBUS Adapter. Use the supplied USB cable as standard. Please note that the use of USB cables with a length of more than 3 m is generally not permitted.	
9	microSD card slot	Without function.	

2.2 Safety notes

Electrical devices may only be installed and mounted by a qualified electrician. In doing so, the applicable accident prevention regulations must be observed. Failure to observe the installation instructions can result in damage to the device, fire or other dangers.

**DANGER!**

Electric shock if live parts are touched. Electric shock may lead to death. Isolate connection cables before working on the device. Cover up live parts in the vicinity!

**IMPORTANT!**

The device must be supplied with voltage by a dedicated power supply unit. Do not use the auxiliary voltage output of a KNX power supply unit which is also supplying a KNX line.

See the installation instructions enclosed with the device for more information.

2.3 Installation and electrical connection

Installing the device

- The device is intended for fixed installation in indoor spaces and dry rooms.
- Snap it on to the top-hat rail as per DIN EN 60715, vertical installation; network connections must face downward.
- ⓘ A KNX data rail is not required; the connection to KNX-TP is established using the accompanying bus connection terminal.
- ⓘ Observe temperature range (0 °C to +45 °C); do not install over heat-emitting devices and ensure sufficient ventilation/cooling if necessary.

Connecting the device

- Route the bus line with the sheathing intact until it is close to the bus connection terminal.
- Firmly press the bus line into the bus connection terminal as far as possible.
- Install bus line leads without sheathing (SELV) reliably disconnected from all non-safety low-voltage cables (SELV/PELV).
- Maintain the specified clearance.
- Attach the cover cap supplied.
- Also see also the VDE regulations governing SELV (DIN VDE 0100-410/"Safe separation", KNX installation regulation) for more information.
- Connect the external power supply to the device's power supply connection (3) using a KNX device connection terminal, preferably yellow/white.
Polarity: left/yellow: (+), white/right: (-).
- **Important:** The device must be supplied with voltage by a dedicated power supply unit. Do not use the auxiliary voltage output of a KNX power supply unit which is also supplying a KNX line.

- Connect one IP network cable to the device's network connection (7).
- Connect the USB interface (8) to the ise eBUS Adapter. Use the supplied USB cable as standard. **Please note that the use of USB cables with a length of more than 3 m is generally not permitted.** When connecting an active ise smart connect KNX Saunier Duval with the ise eBUS Adapter, the initialisation may require up to three minutes. During this time, the ise smart connect KNX Saunier Duval may restart.

Note: The use of the ise smart connect KNX Saunier Duval requires the use of an ise eBUS Adapter. This can be ordered as a set or individually (as a replacement).

Fitting/removing a cover cap

A cover cap can be fitted to protect the KNX bus and power supply connections from dangerous voltages, particularly in the connection area.

The cap is fitted with an attached bus and power supply terminal and a connected bus and power supply line to the rear.

- Fitting the cover cap: The cover cap is pushed over the bus terminal until you hear and feel it lock into position (compare Figure 2: Fitting/removing a cover cap (A)).
- Removing the cover cap: The cover cap is removed by pressing it in slightly on the side and pulling it off to the front (compare Figure 2: Fitting/removing a cover cap (B)).

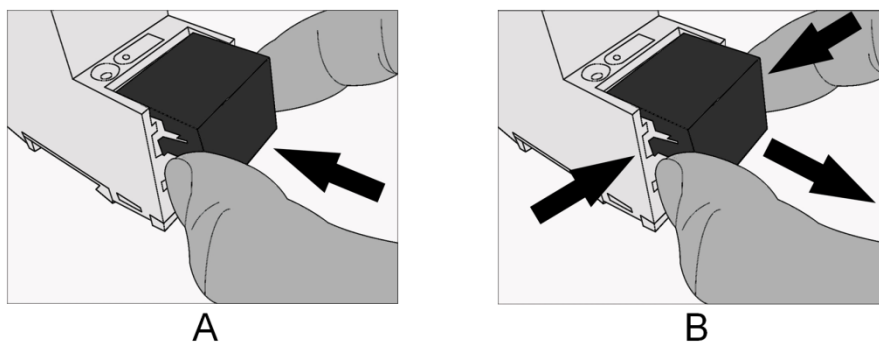

Figure 2: Fitting/removing a cover cap

2.4 Device design ise eBUS Adapter

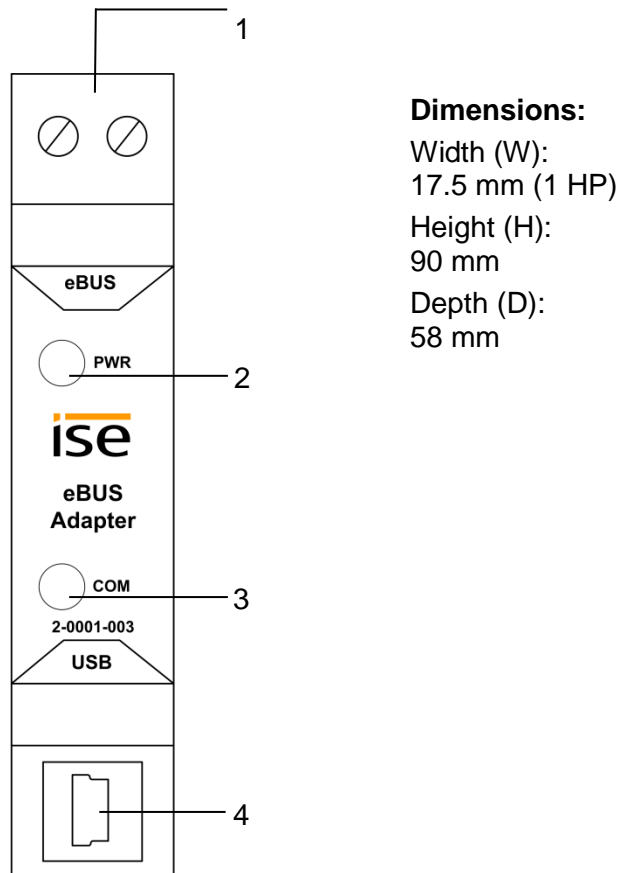

Figure 3: ise eBUS Adapter

1	eBUS connection	Important note: The maximum length of the eBUS connection cable is 125 m. Please see chapter 2.5 “Connecting the ise eBUS Adapter to the eBUS” for the position of the eBUS connection.
2	LED <i>PWR</i> (green)	Green: Minimum voltage from eBUS is connected
3	LED <i>COM</i> (green)	Green: Connection between ise smart connect KNX Saunier Duval with eBUS established
4	USB connection	Important note: The adapter cable for the USB port is equipped with a mini USB-B angle plug. To prevent damage, the angled plug must always be pulled out toward the front. Use the supplied USB cable as standard. Please note that the use of USB cables with a length of more than 3 m is generally not permitted.

See the installation instructions enclosed with the device for more information.

2.5 Connecting the ise eBUS Adapter to the eBUS

The heating technology supplier has installed a junction box in which an eBUS cable is laid from the heating system. The company installing the KNX system will establish the connection to the ise eBUS Adapter in this junction box.

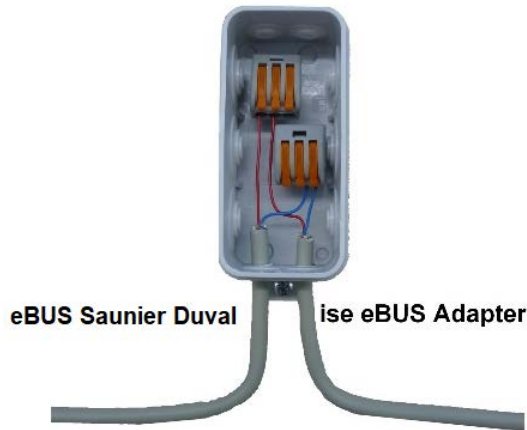

Figure 4: Junction box for the connection of the ise eBUS Adapter to the heating system.

The position of the junction box can be seen in the handover protocol from executing HVAC supplier to the building technology planner (KNX bus system). You can find the required information in Point 7 "Position of eBUS connection point between the Saunier Duval heating system and KNX Gateway".

Once the connection between the KNX system and the eBUS is established, the company installing the KNX system must attach the following sticker enclosed with the product to the Saunier Duval system:



Figure 5: Heating system marking.

It is recommended to attach the sticker here:



Figure 6: Sticker attachment to BMU.

3 Configuration

Configuration of the ise smart connect KNX Saunier Duval system components is divided into the following steps:

Preparations:	For explanations, see
1 Installing ise eBUS Adapter. Connect the ise smart connect KNX Saunier Duval with the ise eBUS Adapter via the USB interface. Use the supplied USB cable as standard. Please note that the use of USB cables with a length of more than 3 m is generally not permitted.	→ Chapter 2
2 Mount ise smart connect KNX Saunier Duval; connect to KNX bus connection and auxiliary power. Important note: The device must be supplied with voltage by a dedicated power supply unit. Do not use the auxiliary voltage output of a KNX power supply unit which is also supplying a KNX line.	→ Chapter 2.3
3 Connect the ise eBUS Adapter with the eBUS in the designated junction box. Important note: The maximum length of the eBUS connection cable is 125 m.	→ Chapter 2.5
4 If necessary, install the ise smart connect KNX Saunier Duval on the IP network and make settings on the IP network router where required.	

Configuration via ETS:

The device can be put into operation after installing the device and connecting the bus, power supply and, if necessary, Ethernet. The preparatory configuration is carried out using the Engineering Tool Software, ETS, available from the KNX Association, see www.knx.org.

1 Create the ise smart connect KNX Saunier Duval as a device in the ETS.	→ Chapter 3.1
2 Assign individual address as usual as appropriate for the KNX topology.	
3 Set IP address, IP subnet mask and default gateway address on the ise smart connect KNX Saunier Duval or select "Obtain an IP address automatically (from a DHCP server)".	→ Chapter 3.3
4 General parameters for setting the ise smart connect KNX Saunier Duval.	→ Chapter 3.4.1
5 Connect group addresses to communication object as usual.	→ Chapter 3.5
6 The ise smart connect KNX Saunier Duval is now ready for commissioning via "Download ETS" and for testing of the functions.	

3.1 Configuration step 1 – Create ise smart connect KNX Saunier Duval as device in the ETS

If you have not already done so, import the ETS device application to the ise smart connect KNX Saunier Duval once in the device catalogue of its ETS, for example using the “Import products” function on the start page of the ETS.

You can download the ETS application from our website under www.ise.de/en/home free of charge.

The other explanations in this document refer to

Hardware	Application software
Device: ise smart connect KNX Saunier Duval	Application:
Manufacturer: ise GmbH	ise smart connect KNX Saunier Duval
Order no.: 1-0006-018	Version: V2.0
Version: V1.0	
Design: DRA (series installation)	

If you already have an ETS project with a previous database entry, you can also update the application program. To do this, drag the new database entry to the project and then select the device with the old database entry. Now select “*Information*” in the device “*Properties*” and then select the “*Application*” tab.

There, you can use the “*Update*” button to replace the old database entry. Existing links with group addresses are not lost. The newly added device can now be deleted again.

3.2 Configuration step 2 – Assigning an individual address

In the ETS, assign the device an individual address as usual as appropriate for the KNX topology.

3.3 Configuration step 3 – Setting the IP address, subnet mask and address of the default gateway

In addition to the individual address on the KNX network, the ise smart connect KNX Saunier Duval can also be assigned an address on the IP data network. This includes the following information:

- IP address,
- subnet mask and the
- address of the default gateway.

This can occur in two ways, either

- automatically by obtaining the data from a DHCP server (e.g. integrated in the router of the data network) or
- making a manual setting in the ETS.

Proceed as follows for this purpose:

1. Select the device in the ETS.

2. Display the device properties in the sidebar on the ETS as shown in Figure 7: ETS device properties dialogue.

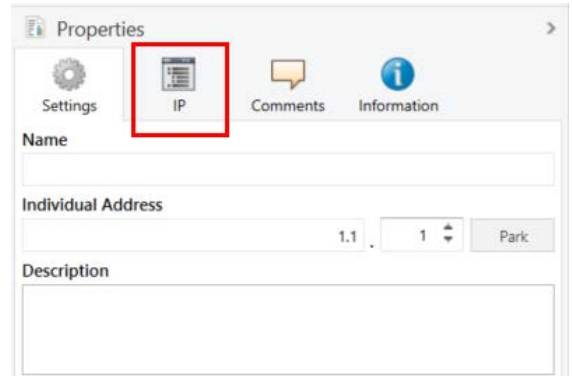

Figure 7: ETS device properties dialogue.

3. Select the "IP" tab according to Figure 8. Then select either

Ⓒ *Obtain an IP address automatically (default)*

The address data are automatically obtained from a DHCP server on the data network.

or

Ⓒ *Use a static IP address*

and enter the data manually.
 You can usually obtain the permitted IP address range and the subnet mask and standard gateway from the router configuration interface.

If the Ⓒ *Obtain an IP address automatically* setting is used, a DHCP server must issue a valid IP address to the ise smart connect KNX Saunier Duval.

If a DHCP server is not available for this setting, the device starts up after a waiting time with an AutoIP address (address range from 169.254.1.0 to 169.254.254.255).

As soon as a DHCP server is available, the device is automatically assigned a new IP address.

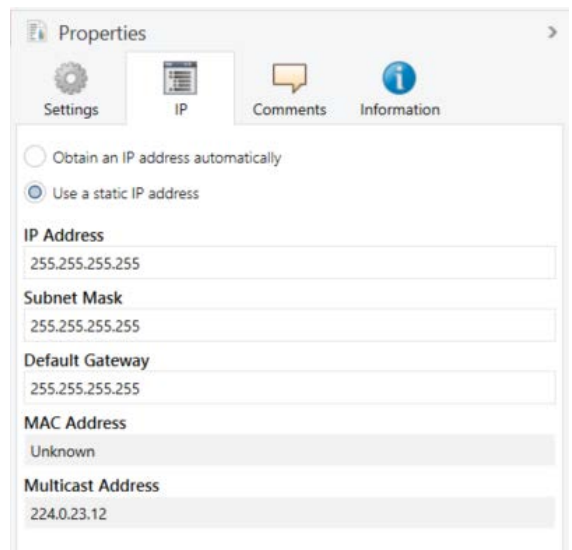

Figure 8: Setting for the device's IP address data on the "IP" tab in the sidebar of the ETS.

3.4 Setting general parameters

3.4.1 System dimensioning parameters

In the first part of the parametrisation, a prompt is given for system dimensioning. Take the system dimensioning from the handover protocol from the HVAC supplier. However, if you have updated the ETS application, check the system dimensioning and complete the handover protocol if necessary.

Individual components are requested separately. The default value of each parameter is marked in **bold**.

System dimensioning	Components	Entry / Selection	Remarks
Heat generator	A Saunier Duval gas boiler is available	Yes No	
Heat generator	A Saunier Duval heat pump is available	Yes No	
Solar thermal system	A solar thermal system is available, the data from which the system controller records	Yes No	
Solar thermal system	A Saunier Duval GHS is available	Yes No	Only visible if yes was the answer to the previous point.
Heat generator	Heat generator 1 is available	Yes No	
Heat generator	Heat generator 2 is available	Yes No	
Heat generator	Heat generator 3 is available	Yes No	
Heat generator	Heat generator 4 is available	Yes No	
Heat generator	Heat generator 5 is available	Yes No	
Heat generator	Heat generator 6 is available	Yes No	

System dimensioning	Components	Entry / Selection	Remarks
Heat generator	Heat generator 7 is available	Yes No	
Heat generator	Heat generator 8 is available	Yes No	
Heating circuit 1	A heating circuit 1 is available for room heating	Yes No	
"	The cooling function for circuit 1 is activated on the system controller	Yes No	
Heating circuit 2	A heating circuit 2 is available for room heating	Yes No	
"	The cooling function for circuit 2 is activated on the system controller	Yes No	
Heating circuit 3	A heating circuit 3 is available for room heating	Yes No	
"	The cooling function for circuit 3 is activated on the system controller	Yes No	
Hot water	Hot water is controlled via the system controller	Yes No	
"	A mixer circuit is configured as a cylinder charging circuit for hot water cylinder charging	Yes No	

System dimensioning	Components	Entry / Selection	Remarks
Sensors	The automatic date/time functions at the system's location	Yes No	
"	The system controller shows the fuel consumption (gas consumption) in the "Information" menu	Yes No	
"	The system controller shows the consumption (electricity consumption) in the "Information" menu	Yes No	
"	The system controller shows the water pressure in the "Information/System status" menu	Yes No	
"	The heating system should be re-filled with water if it falls below the following water pressure	0 bar	

3.4.2 Parameters use cases

In the second part of the parametrisation, a prompt is given for corresponding use cases. The possible use cases are already defined by the system dimensioning. Simply mark the cases you wish with a tick. No ticks are marked during the first call-up.

Note that all supported use cases appear in the following list. The actual use cases possible for a system depend on the system dimensioning. Only these will be offered by the ETS.

Rubric	Use cases
Smart control	I would like "Standby" activation in my home, so I can also switch my heating to "Standby".
"	I would like to be able to configure hot water heating and heating in my visualisation with time control.
"	I always would like to carry out short-term changes to my regular heating and hot water control in order to maintain a pleasant room temperature and hot water during longer periods of presence (e.g. overtime in the office or party at home).
Information	I would like to see the energy yield of my heat pump and solar thermal system in my visualisation in order to monitor the overall yield of my system.
"	I would like to be able to see the energy consumption of my Saunier Duval system in my visualisation in order to display the current value and historical diagrams.
"	I would like to see the system status of my Saunier Duval system in my visualisation in order to have constant reassurance that everything is okay.
"	I would like to see the current water pressure of the system in my visualisation and be able to activate an alarm if it becomes too low in order to be able to react to it.

3.4.3 Time settings

The time settings are made in the third part of parametrisation.

You can enter the time intervals when the time and date are sent from the system controller to the KNX system under *Clock*.

You select how the cooling time is to be set under *Manual cooling function*.

The individual time settings are queried separately during this process. The default value of each parameter is marked in **bold**.



Rubric	Time settings	Entry / Selection
Clock	Send time	Every minute Every hour Every day
"	Send date	Every minute Every hour Every day
Manual cooling function	Set cooling time	Number of cooling days Cooling interval

3.5 Connecting group addresses to group communication objects

Different group objects are available for connecting group addresses on the ise smart connect KNX Saunier Duval. The visibility of the group communication object is dependent on the setting in the chapters 3.4.1 "System dimensioning parameters" and 3.4.2 "Parameters use cases". Dependency is specified for each communication object in italics under "Description".

Note on querying status values on the system controller:

- Communication objects whose query frequency is prioritised:
The ise smart connect KNX Saunier Duval updates the information on the heating system's status at regular intervals based on prioritisation. Any changes to the status are thus only identified during the next query.
- Communication objects which are not subject to prioritisation:
The ise smart connect KNX Saunier Duval updates the information based on events. Changes to the status are thus identified in real time.
- It is possible that values are made available by the heating regulator for a longer period of time. This means that, even if the values are polled by the ise smart connect KNX Saunier Duval at shorter intervals, the values on the KNX bus do not change until updating occurs in the heating regulator. It may also be the case that values which have already been updated are shown on the controller's display, but are not available to the ise smart connect KNX Saunier Duval yet. In addition to prioritisation, the updating time on the controller is also indicated for communication objects concerned.

Object	Name	Direction	Data width	DP type	Flags (CRWTU)
 1	System in service mode	Read	1 bit	1.011	CR-T-
Rubric:	Connections	Data type:		Status	
Function:	Indicates whether the system's service mode is active. Cycle time: max. 5.5 minutes				
Description:	This communication object is always visible.				
 2	Fault heating generator	Read	1 bit	1.002	CR-T-
Rubric:	Connections	Data type:		Boolean	
Function:	Indicates whether one of the available heat generators has an error. Cycle time: max. 9 minutes				
Description:	This communication object is always visible. True = Error exists				

Object	Name	Direction	Data width	DP type	Flags (CRWTU)
 3	Time	Read	3 bytes	10.001	CR-T-
Rubric:	Date/time	Data type:	Time of day		
Function:	Provides the Saunier Duval system time Cycle time: max. 3 minutes Clock interval: Every minute/every hour/every day				
Description:	This communication object is visible when the automatic date/time configuration functions at the system's location. <i>Parameters > System dimensioning > Sensors > The automatic date/time functions at the system's location <yes></i>				

Object	Name	Direction	Data width	DP type	Flags (CRWTU)
 4	Date	Read	3 bytes	11.001	CR-T-
Rubric:	Date/time	Data type:	Date		
Function:	Provides the Saunier Duval system date. Cycle time: max. 3 minutes Clock interval: Every minute/every hour/every day				
Description:	This communication object is visible when the automatic date/time configuration functions at the system's location. <i>Parameters > System dimensioning > Sensors > The automatic date/time functions at the system's location <yes></i>				

Object	Name	Direction	Data width	DP type	Flags (CRWTU)
 5	Outside temperature	Read	2 bytes	9.001	CR-T-
Rubric:	Temperature	Data type:	Temperature (°C)		
Function:	Provides the outside temperature. Cycle time: max. 3 minutes Value range > - 40 °C				
Description:	This communication object is always visible. If the value is - 40 °C or lower, error code 7 is sent to group communication object 12. This can indicate a defect in the temperature sensor.				

Object	Name	Direction	Data width	DP type	Flags (CRWTU)
 6	System status "Standby"	Read	1 bit	1.011	CR-T-
Rubric:		Data type:	Status		
Function:	Indicates whether the system is in "Standby" mode. Cycle time: max. 3 minutes				
Description:	This communication object is always visible.				

Object	Name	Direction	Data width	DP type	Flags (CRWTU)
 7	System status "Heating"	Read	1 bit	1.011	CR-T-
Rubric:	Data type:		Status		
Function:	Indicates whether the system is in "Heating" mode. Cycle time: max. 3 minutes				
Description:	<p>This communication object is visible when a heating circuit is available and the corresponding use case has been selected.</p> <p><i>Parameters > System dimensioning > Heating circuit N > A heating circuit N is available for room heating <yes></i> and <i>Parameters > Use cases > Information > I would like to see the system status of my Saunier Duval system (...) <✓></i></p>				

Object	Name	Direction	Data width	DP type	Flags (CRWTU)
 8	System status "Cooling"	Read	1 bit	1.011	CR-T-
Rubric:	Data type:		Status		
Function:	Indicates whether the system is in "Cooling" mode. Cycle time: max. 3 minutes				
Description:	<p>This communication object is visible when the Saunier Duval system is also to be used for cooling.</p> <p>The requirement for this is a heating circuit which has the cooling function activated and the corresponding use case has been selected.</p> <p><i>Parameters > System dimensioning > Heating circuit N > A heating circuit N is available for room heating <yes></i> and <i>Parameters > System dimensioning > Heating circuit N > The cooling function for circuit N is activated in the system controller <yes></i> and <i>Parameters > Use cases > Information > I would like to see the system status of my Saunier Duval system (...) <✓></i></p>				

Object	Name	Direction	Data width	DP type	Flags (CRWTU)
--------	------	-----------	------------	---------	---------------

	9	System status "DHW"	Read	1 bit	1.011 CR-T-
---	---	---------------------	------	-------	-------------

Rubric: Data type: Status

Function: Indicates whether the system is in "Hot water" mode.
 Cycle time: max. 3 minutes

Description: This communication object is visible when the hot water is controlled by the system controller. Please note that control via the system controller is not possible if a mixer circuit is configured as a cylinder charging circuit for the hot water cylinder charging. This communication object is not visible in this case.

Parameters > System dimensioning > Hot water > Hot water is controlled via the system controller <yes>

and

Parameters > Use cases > Information > I would like to see the system status of my Saunier Duval system (...) <✓>

Object	Name	Direction	Data width	DP type	Flags (CRWTU)
--------	------	-----------	------------	---------	---------------

	10	Water pressure	Read	2 bytes	9.006 CR-T-
---	----	----------------	------	---------	-------------

Rubric: Data type: Pressure (Pa)

Function: Displays the current water pressure of the system.
 Cycle time: max. 3 minutes
 Value range: 0–670760 Pa (0–6.70760 bar)
 Replacement value: NaN (not a number) if the sensor is not available or is defective.

Description: This communication object is visible when the current water pressure in the Saunier Duval system is to be displayed.
 The requirement for this is that the system controller must display the system pressure and the corresponding use case must be selected.

Parameters > System dimensioning > Sensors > The system controller shows the water pressure in the "Information/System status" menu <yes>

and

Parameters > Use cases > Information > I would like to see the current water pressure of the system (...) <✓>

If the system pressure exceeds the value of 6.70760 bar, error code 7 is sent to communication object 12.

Object	Name	Direction	Data width	DP type	Flags (CRWTU)
 11	KNX gateway error	Read	1 bit	1.002	CR-T-
Rubric:	Connections	Data type:		Boolean	
Function:	Indicates whether the KNX gateway has an error.				
Description:	This communication object is always visible. True = Error exists				

Object	Name	Direction	Data width	DP type	Flags (CRWTU)
 12	Last KNX gateway error	Read	1 bytes	20.*	CR-T-
Rubric:	Error	Data type:		1 byte	
Function:	Error code of the last KNX gateway error				
Description:	<p>This communication object is always visible.</p> <p>1 = System controller not found. eBUS communication is possible, but no system controller was found.</p> <p>2 = Reserved for subsequent use.</p> <p>3 = Error in communication with the ise eBUS Adapter. Communication between the ise smart connect KNX Saunier Duval and the ise eBUS Adapter is not possible via USB.</p> <p>4 = eBUS cable is not connected. eBUS connection not recognised.</p> <p>5 = No answer from the eBUS. No answer to query from eBUS.</p> <p>6 = Value is not supported. There is no corresponding eBUS value for a KNX value.</p> <p>7 = Value not permitted. The received value is not within the permitted range (eBUS and KNX)</p> <p>LED status displays on the ise smart connect KNX Saunier Duval are allocated to the error codes 1 to 4. The corresponding values are described in chapter 4.2.2 "LED status display in operation".</p>				

Object	Name	Direction	Data width	DP type	Flags (CRWTU)
 13	Heating/Cooling	Read	1 bit	1.100	CR-T-

Rubric: Data type: Cooling/heating

Function: Indicates whether the system is in "Heating" or "Cooling" mode.
 Cycle time: max. 3 minutes

Description: 1 = Heating (initial value)
 0 = Cooling
 The requirement for this is the installation of a Saunier Duval heat pump, a heating circuit which has the cooling function activated and the corresponding use case has been selected.
Parameters > System dimensioning > Heat generator > A Saunier Duval heat pump is available <yes>
 and
Parameters > System dimensioning > Heating circuit N > A heating circuit N is available for room heating <yes>
 and
Parameters > System dimensioning > Heating circuit N > The cooling function for circuit N is activated on the system controller <yes>
 and
Parameters > Use cases > Information > I would like to see the system status of my Saunier Duval system (...) <✓>

Object	Name	Direction	Data width	DP type	Flags (CRWTU)
 14	Solar thermal collector array – temperature	Read	2 bytes	9.001	CR-T-
Rubric:	Data type:		Temperature (°C)		
Function:	Displays the current temperature in the solar thermal collector array. Cycle time: max. 3 minutes Value range: 25-155 °C Replacement value: NaN (not a number); for values <25				
Description:	The requirement for this is the installation of a solar thermal system connected to the system controller and selection of the corresponding use case. Ensure that the system controller cannot be used to control if a Saunier Duval GHS is used. This communication object is not visible in this case. <i>Parameters > System dimensioning > Solar thermal system > A solar thermal system is available, (...) <yes></i> and <i>Parameters > System dimensioning > Solar thermal system > A Saunier Duval GHS is available <no></i>				

Object	Name	Direction	Data width	DP type	Flags (CRWTU)
 15	System flow temperature	Read	2 bytes	9.001	CR-T-
Rubric:	Data type:		Temperature (°C)		
Function:	Displays the system's current flow temperature. Cycle time: max. 3 minutes Value range: 0-99 °C				
Description:	This communication object is visible when a heating circuit and/or at least two heat generators are available and the corresponding use case has been selected. <i>Parameters > System dimensioning > Heating circuit X > Heating circuit X is available for room heating <yes></i> and <i>Parameters > System dimensioning > Heating circuit Y > Heating circuit Y is available for room heating <yes></i> or <i>Parameters > System dimensioning > Heat generator > Heat generator X is available <yes></i> and <i>Parameters > System dimensioning > Heat generator > Heat generator Y is available <yes></i>				

Object	Name	Direction	Data width	DP type	Flags (CRWTU)
 20	Domestic hot water circuit – operation mode	Write	1 bytes	20.103	CRWT-
Rubric:		Data type:	DHW mode		
Function:	<p>Sets and reads the operation mode of the domestic hot water circuit. The following assignment of the KNX to controller mode is used:</p> <p>Auto = Auto LegioProtect = Not supported Normal = Day Reduced = Not supported Off/FrostProtect = Off</p> <p>If an unsupported mode is sent, error code 6 is sent over communication object 12. Cycle time: max. 35 seconds</p>				
Description:	<p>This communication object is visible when the system controller controls the hot water.</p> <p>Please note that control via the system controller is not possible if a mixer circuit is configured as a cylinder charging circuit for the hot water cylinder charging. This communication object is not visible in this case.</p> <p><i>Parameters > System dimensioning > Hot water > Hot water is controlled via the system controller <yes></i> and <i>Parameters > Use cases > Smart control > Any use case <✓></i></p>				

Object	Name	Direction	Data width	DP type	Flags (CRWTU)
 21	Domestic hot water circuit – "Auto" operation mode	Write	1 bit	1.011	CRWT-
Rubric:		Data type:	Status		
Function:	<p>Activates the "Auto" operation mode for the domestic hot water circuit or shows whether this is active. Corresponds to "Auto" of data type DHW mode. Cycle time: max. 35 seconds</p>				
Description:	<p>This communication object is visible when the system controller controls the hot water.</p> <p>Please note that control via the system controller is not possible if a mixer circuit is configured as a cylinder charging circuit for the hot water cylinder charging. This communication object is not visible in this case.</p> <p><i>Parameters > System dimensioning > Hot water > Hot water is controlled via the system controller <yes></i> and <i>Parameters > Use cases > Smart control > Any use case <✓></i></p>				

Object	Name	Direction	Data width	DP type	Flags (CRWTU)
 22	Domestic hot water circuit – “Day” operation mode	Write	1 bit	1.011	CRWT-

Rubric: Data type: Status

Function: Activates the "Day" operation mode for the domestic hot water circuit or shows whether this is active. Corresponds to "Normal" of data type DHW mode.
Cycle time: max. 35 seconds

Description: This communication object is visible when the system controller controls the hot water.
Please note that control via the system controller is not possible if a mixer circuit is configured as a cylinder charging circuit for the hot water cylinder charging. This communication object is not visible in this case.
Parameters > System dimensioning > Hot water > Hot water is controlled via the system controller <yes>
and
Parameters > Use cases > Smart control > Any use case <✓>

Object	Name	Direction	Data width	DP type	Flags (CRWTU)
 23	Domestic hot water circuit – "Off" operation mode	Write	1 bit	1.011	CRWT-

Rubric: Data type: Status

Function: Activates the "Off" operation mode for the domestic hot water circuit or shows whether this mode is active. Corresponds to "Off" of data type DHW mode.
Cycle time: max. 35 seconds

Description: This communication object is visible when the system controller controls the hot water.
Please note that control via the system controller is not possible if a mixer circuit is configured as a cylinder charging circuit for the hot water cylinder charging. This communication object is not visible in this case.
Parameters > System dimensioning > Hot water > Hot water is controlled via the system controller <yes>
and
Parameters > Use cases > Smart control > Any use case <✓>

Object	Name	Direction	Data width	DP type	Flags (CRWTU)
 24	Domestic hot water circuit – hot water setpoint value	Write	2 bytes	9.001	CRWT-
Rubric:	Data type: Temperature (°C)				
Function:	Sets and reads the current setpoint value for the domestic hot water circuit. Cycle time: max. 35 seconds Value range: 35-70 °C				
Description:	<p>This communication object is visible when the system controller controls the hot water.</p> <p>Please note that control via the system controller is not possible if a mixer circuit is configured as a cylinder charging circuit for the hot water cylinder charging. This communication object is not visible in this case.</p> <p><i>Parameters > System dimensioning > Hot water > Hot water is controlled via the system controller <yes></i> and <i>Parameters > Use cases > Smart control > I would like to be able to configure hot water heating and heating in my visualisation with time control <✓></i></p> <p>If a value outside the value range is written to this communication object, error code 7 is sent to communication object 12.</p>				

Object	Name	Direction	Data width	DP type	Flags (CRWTU)
 25	Domestic hot water circuit – 1x cylinder charge	Write	1 bit	1.011	CRWT-
Rubric:	Data type: Status				
Function:	Activates or deactivates the "One-time cylinder charge" mode for the domestic hot water circuit and displays this status. Cycle time: max. 35 seconds				
Description:	<p>This communication object is visible when the system controller controls the hot water.</p> <p>Please note that control via the system controller is not possible if a mixer circuit is configured as a cylinder charging circuit for the hot water cylinder charging. This communication object is not visible in this case.</p> <p><i>Parameters > System dimensioning > Hot water > Hot water is controlled via the system controller <yes></i> and <i>Parameters > Use cases > Smart control > I always would like to carry out short-term changes to my regular heating and hot water control (...)<✓></i></p>				

Object	Name	Direction	Data width	DP type	Flags (CRWTU)
 26	Domestic hot water circuit – circulation pump	Read	1 bit	1.011	CR-T-

Rubric:

Data type:

Status

Function:

Displays the operating state of the circulation pump in the domestic hot water circuit.
 Cycle time: max. 3 minutes

Description:

This communication object is visible when the system controller controls the hot water.
 Please note that control via the system controller is not possible if a mixer circuit is configured as a cylinder charging circuit for the hot water cylinder charging. This communication object is not visible in this case.
Parameters > System dimensioning > Hot water > Hot water is controlled via the system controller <yes>
 and
Parameters > System dimensioning > Hot water > A mixer circuit is configured as a cylinder (...) <no>
 and
Parameters > Use cases > Information > I would like to see the system status of my Saunier Duval system (...) <✓>

Object	Name	Direction	Data width	DP type	Flags (CRWTU)
 27	Domestic hot water circuit – charging pump or 3-way valve	Read	1 bit	1.011	CR-T-
Rubric:	Data type:		Status		
Function:	<p>Displays the status of the charging pump or 3-way valve in the domestic hot water circuit. Cycle time: max. 3 minutes</p>				
Description:	<p>This communication object is visible when the system controller controls the hot water.</p> <p>Please note that control via the system controller is not possible if a mixer circuit is configured as a cylinder charging circuit for the hot water cylinder charging. This communication object is not visible in this case.</p> <p><i>Parameters > System dimensioning > Hot water > Hot water is controlled via the system controller <yes></i> and <i>Parameters > System dimensioning > Hot water > A mixer circuit is configured as a cylinder (...) <no></i> and <i>Parameters > Use cases > Information > I would like to see the system status of my Saunier Duval system (...) <✓></i></p>				

Object	Name	Direction	Data width	DP type	Flags (CRWTU)
 28	Domestic hot water circuit – hot water temperature	Read	2 bytes	9.001	CR-T-
Rubric:		Data type:	Temperature (°C)		
Function:	<p>Displays the current hot water temperature. Cycle time: max. 3 minutes Value range: 0-99 °C</p>				
Description:	<p>This communication object is visible when the system controller controls the hot water.</p> <p>Please note that control via the system controller is not possible if a mixer circuit is configured as a cylinder charging circuit for the hot water cylinder charging. This communication object is not visible in this case.</p> <p><i>Parameters > System dimensioning > Hot water > Hot water is controlled via the system controller <yes></i> and <i>Parameters > System dimensioning > Hot water > A mixer circuit is configured as a cylinder (...) <no></i> and <i>Parameters > Use cases > Information > I would like to see the system status of my Saunier Duval system (...) <✓></i></p>				

Object	Name	Direction	Data width	DP type	Flags (CRWTU)
 34	Cooling days – manual cooling	Write	1 bytes	5.010	CRWT-
Rubric:		Data type:		Counter pulse	
Function:	Sets and reads the number of days for manual cooling. Cycle time: max. 35 seconds Value range: 0-255 days				
Description:	<p>This communication object is visible when a Saunier Duval heat pump is available and the cooling function is activated for at least one heating circuit in the system controller.</p> <p><i>Parameters > System dimensioning > Heat generator > A Saunier Duval heat pump is available <yes></i> and <i>Parameters > System dimensioning > Heating circuit N > A heating circuit N is available for room heating <yes></i> and <i>Parameters > System dimensioning > Heating circuit N > The cooling function for circuit N is activated on the system controller <yes></i> and <i>Parameters > Use cases > Smart control > I would like to be able to configure hot water heating and heating in my visualisation with time control <✓></i> and <i>Parameters > Time settings > Manual cooling function > Set cooling time > Number of cooling days <✓></i></p> <p>If a value outside the value range is written to this communication object, error code 7 is sent to communication object 12.</p>				

Object	Name	Direction	Data width	DP type	Flags (CRWTU)
 35	Cooling interval – start	Write	3 bytes	11.001	CRWT-
Rubric:		Data type:		Date	
Function:	Sets and reads the start of the cooling interval. Cycle time: max. 35 seconds Value range: DD.MM.YY				
Description:	<p>This communication object is visible when a Saunier Duval heat pump is available and the cooling function is activated for at least one heating circuit in the system controller.</p> <p><i>Parameters > System dimensioning > Heat generator > A Saunier Duval heat pump is available <yes></i> and <i>Parameters > System dimensioning > Heating circuit N > A heating circuit N is available for room heating <yes></i> and <i>Parameters > System dimensioning > Heating circuit N > The cooling function for circuit N is activated on the system controller <yes></i> and <i>Parameters > Use cases > Smart control > I would like to be able to configure hot water heating and heating in my visualisation with time control <✓></i> and <i>Parameters > Time settings > Manual cooling function > Set cooling time > Cooling interval <✓></i></p>				

Object	Name	Direction	Data width	DP type	Flags (CRWTU)
 36	Cooling interval – end	Write	3 bytes	11.001	CRWT-
Rubric:		Data type:		Date	
Function:	Sets and reads the end of the cooling interval. Cycle time: max. 35 seconds Value range: DD.MM.YY				
Description:	This communication object is visible when a Saunier Duval heat pump is available and the cooling function is activated for at least one heating circuit in the system controller. <i>Parameters > System dimensioning > Heat generator > A Saunier Duval heat pump is available <yes></i> and <i>Parameters > System dimensioning > Heating circuit N > A heating circuit N is available for room heating <yes></i> and <i>Parameters > System dimensioning > Heating circuit N > The cooling function for circuit N is activated on the system controller <yes></i> and <i>Parameters > Use cases > Smart control > I would like to be able to configure hot water heating and heating in my visualisation with time control <✓></i> and <i>Parameters > Time settings > Manual cooling function > Set cooling time > Cooling interval <✓></i>				

Object	Name	Direction	Data width	DP type	Flags (CRWTU)
 50	Energy yields – solar yield	Read	4 bytes	13.013	CR-T-
Rubric:	Data type: Active energy (kWh)				
Function:	Provides the accumulated solar yield which was read during the last query. Cycle time: max. 9 minutes Updating in the controller: up to 24 hr				
Description:	<p>This communication object is visible when the thermal solar yield from a solar thermal system is to be displayed. The requirement for this is that the system controller must record the data and the corresponding use case must be selected.</p> <p><i>Parameters > System dimensioning > Solar thermal system > A solar thermal system is available, (...) <yes></i> and <i>Parameters > Use cases > Information > I would like to see the energy yield of my heat pump and solar thermal system (...) <✓></i></p>				

Object	Name	Direction	Data width	DP type	Flags (CRWTU)
 51	Energy yields – environmental yield	Read	4 bytes	13.013	CR-T-
Rubric:	Data type: Active energy (kWh)				
Function:	Provides the accumulated environmental yield which was read during the last query. Cycle time: max. 9 minutes Updating in the controller: up to 24 hr				
Description:	<p>This communication object is visible when the environment yield of a Saunier Duval heat pump is to be displayed. The requirement for this is that the system controller must record the data and the corresponding use case must be selected.</p> <p><i>Parameters > System dimensioning > Heat generator > A Saunier Duval heat pump is available (...) <yes></i> and <i>Parameters > Use cases > Information > I would like to see the energy yield of my heat pump and solar thermal system (...) <✓></i></p>				

Object	Name	Direction	Data width	DP type	Flags (CRWTU)
 52	Energy consumption – consumption gas for heating	Read	4 bytes	13.013	CR-T-
Rubric:	Data type: Active energy (kWh)				
Function:	Provides the accumulated gas consumption for heating which was read during the last query. Cycle time: max. 9 minutes Updating in the controller: up to 24 hr				
Description:	<p>This communication object is visible if a Saunier Duval gas boiler is available, the system controller records the data and the corresponding use case was selected.</p> <p><i>Parameters > System dimensioning > Heat generator > A Saunier Duval gas boiler is available <yes></i> and <i>Parameters > System dimensioning > Sensors > The system controller shows the fuel consumption (gas consumption) (...) <yes></i> and <i>Parameters > Use cases > Information > I would like to be able to see the energy consumption (...) <✓></i></p>				

Object	Name	Direction	Data width	DP type	Flags (CRWTU)
 53	Energy consumption – consumption gas for hot water	Read	4 bytes	13.013	CR-T-
Rubric:	Data type: Active energy (kWh)				
Function:	Provides the accumulated gas consumption for hot water which was read during the last query. Cycle time: max. 9 minutes Updating in the controller: up to 24 hr				
Description:	<p>This communication object is visible if a Saunier Duval gas boiler is available, the system controller records the data and the corresponding use case was selected.</p> <p><i>Parameters > System dimensioning > Heat generator > A Saunier Duval gas boiler is available (...) <yes></i> and <i>Parameters > System dimensioning > Sensors > The system controller shows the fuel consumption (gas consumption) (...) <yes></i> and <i>Parameters > Use cases > Information > I would like to be able to see the energy consumption (...) <✓></i></p>				

Object	Name	Direction	Data width	DP type	Flags (CRWTU)
 54	Energy consumption – consumption electricity for heating	Read	4 bytes	13.013	CR-T-
Rubric:	Data type:		Active energy (kWh)		
Function:	Provides the accumulated current consumption for heating which was read during the last query. Cycle time: max. 9 minutes Updating in the controller: up to 24 hr				
Description:	<p>This communication object is visible when the system controller displays the consumption (electricity consumption) and the corresponding use case has been selected.</p> <p><i>Parameters > System dimensioning > Sensors > The system controller shows the consumption (electricity consumption) (...) <yes></i> and <i>Parameters > Use cases > Information > I would like to be able to see the energy consumption (...) <✓></i></p>				

Object	Name	Direction	Data width	DP type	Flags (CRWTU)
 55	Energy consumption – consumption electricity for hot water	Read	4 bytes	13.013	CR-T-
Rubric:	Data type:		Active energy (kWh)		
Function:	Provides the accumulated current consumption for hot water which was read during the last query. Cycle time: max. 9 minutes Updating in the controller: up to 24 hr				
Description:	<p>This communication object is visible when the system controller displays the consumption (electricity consumption) and the corresponding use case has been selected.</p> <p><i>Parameters > System dimensioning > Sensors > The system controller shows the consumption (electricity consumption) (...) <yes></i> and <i>Parameters > Use cases > Information > I would like to be able to see the energy consumption (...) <✓></i></p>				

Important note:

The MiPro Sense system controller provides different HVAC operation modes. You will find the assignment to the KNX operation modes in the table:



KNX	MiPro Sense
Building Protection	Off
Auto	Time Controlled
Comfort	Manual
Economy	Manual
Standby	Manual

The following applies to the system controller:

- The last KNX operating mode selected which leads to activation of "Manual" controller mode, is stored internally. The "Comfort" controller mode is used initially.
- The setpoint temperatures "Day temperature heating" and "Set-back temperature heating" are used by the system controller as data points for the KNX to set the "Manual temperature" on the controller when the KNX operating mode is switched. No controller temperature value is sent to any of these communication objects. The previously configured setpoint value is used when the ise smart connect KNX Saunier Duval is restarted.
- Changing the manual temperature value on the system controller does not result in any changes to the KNX.

Object	Name	Direction	Data width	DP type	Flags (CRWTU)
 60	Heating zone 1 – operation mode	Write	1 bytes	20.102	CRWT-
Rubric:	Data type:		HVAC mode		
Function:	<p>Sets and reads the operation mode of heating zone 1. You will find the assignment of KNX operation modes to the system controller in the table on page 42. For communication object 63, the assignment is set to the last "Standby" or "Economy" value sent. Cycle time: max. 35 seconds</p>				
Description:	<p>This communication object is visible when a heating circuit 1 is available and the corresponding use case has been selected.</p> <p><i>Parameters > System dimensioning > Heating circuit 1 > A heating circuit 1 is available for room heating <yes></i> and <i>Parameters > Use cases > Smart control > Any use case <✓></i></p>				

Object	Name	Direction	Data width	DP type	Flags (CRWTU)
 61	Heating zone 1 – "Auto" operation mode	Write	1 bit	1.011	CRWT-
Rubric:	Data type:		Status		
Function:	<p>Activates the "Auto" operation mode for heating zone 1 or shows whether this is active. Corresponds to "Auto" of data type HVAC mode. Cycle time: max. 35 seconds</p>				
Description:	<p>This communication object is visible when a heating circuit 1 is available and the corresponding use case has been selected.</p> <p><i>Parameters > System dimensioning > Heating circuit 1 > A heating circuit 1 is available for room heating <yes></i> and <i>Parameters > Use cases > Smart control > Any use case <✓></i></p>				

Object	Name	Direction	Data width	DP type	Flags (CRWTU)
 62	Heating zone 1 – "Day" operation mode	Write	1 bit	1.011	CRWT-
Rubric:		Data type:		Status	
Function:	<p>Activates the "Day" operation mode for heating zone 1 or shows whether this is active. Corresponds to "Comfort" of data type HVAC mode.</p> <p>Cycle time: max. 35 seconds</p>				
Description:	<p>This communication object is visible when a heating circuit 1 is available and the corresponding use case has been selected.</p> <p><i>Parameters > System dimensioning > Heating circuit 1 > A heating circuit 1 is available for room heating <yes></i></p> <p>and</p> <p><i>Parameters > Use cases > Smart control > Any use case <✓></i></p>				
Object	Name	Direction	Data width	DP type	Flags (CRWTU)
 63	Heating zone 1 – "Night" operation mode	Write	1 bit	1.011	CRWT-
Rubric:		Data type:		Status	
Function:	<p>Activates the "Night" operation mode for heating zone 1 or shows whether this is active. Corresponds to "Economy" or "Standby" of data type HVAC mode. The last value written on communication object 60 is decisive for this state. "Economy" is used as standard.</p> <p>Cycle time: max. 35 seconds</p>				
Description:	<p>This communication object is visible when a heating circuit 1 is available and the corresponding use case has been selected.</p> <p><i>Parameters > System dimensioning > Heating circuit 1 > A heating circuit 1 is available for room heating <yes></i></p> <p>and</p> <p><i>Parameters > Use cases > Smart control > Any use case <✓></i></p>				

Object	Name	Direction	Data width	DP type	Flags (CRWTU)
 64	Heating zone 1 – "Off" operation mode	Write	1 bit	1.011	CRWT-
Rubric:		Data type:		Status	
Function:	Activates the "Off" operation mode for heating zone 1 or shows whether this is active. Corresponds to "Building Protection" of data type HVAC mode. Cycle time: max. 35 seconds				
Description:	This communication object is visible when a heating circuit 1 is available and the corresponding use case has been selected. <i>Parameters > System dimensioning > Heating circuit 1 > A heating circuit 1 is available for room heating <yes></i> and <i>Parameters > Use cases > Smart control > Any use case <✓></i>				



Object	Name	Direction	Data width	DP type	Flags (CRWTU)
 65	Heating zone 1 – day temperature heating	Write	2 bytes	9.001	CRWT-
Rubric:		Data type:		Temperature (°C)	
Function:	Sets and reads the current setpoint value for the day temperature in heating zone 1. See note on page 42 for MiPro Sense Value range: 5-30 °C				
Description:	This communication object is visible when a heating circuit 1 is available and the corresponding use case has been selected. <i>Parameters > System dimensioning > Heating circuit 1 > A heating circuit 1 is available for room heating <yes></i> and <i>Parameters > Use cases > Smart control > I would like to be able to configure hot water heating and heating (...) with time control <✓></i> If a value outside the value range is written to this communication object, error code 7 is sent to communication object 12.				

Object	Name	Direction	Data width	DP type	Flags (CRWTU)
 66	Heating zone 1 – set-back temperature heating	Write	2 bytes	9.001	CRWT-
Rubric:	Data type: Temperature (°C)				
Function:	Sets and reads the current setpoint value for the night temperature in heating zone 1. See note on page 42 for MiPro Sense Value range: 5-30 °C				
Description:	<p>This communication object is visible when a heating circuit 1 is available and the corresponding use case has been selected.</p> <p><i>Parameters > System dimensioning > Heating circuit 1 > A heating circuit 1 is available for room heating <yes></i> and <i>Parameters > Use cases > Smart control > I would like to be able to configure hot water heating and heating (...) with time control <✓></i></p> <p>If a value outside the value range is written to this communication object, error code 7 is sent to communication object 12.</p>				

Object	Name	Direction	Data width	DP type	Flags (CRWTU)
 67	Heating zone 1 – day temperature cooling	Write	2 bytes	9.001	CRWT-
Rubric:	Data type: Temperature (°C)				
Function:	Sets and reads the current setpoint value for the day temperature cooling in heating zone 1. Cycle time: max. 35 seconds Value range: 15-30 °C				
Description:	<p>This communication object is visible if a Saunier Duval heat pump and a heating circuit 1 is available, the cooling function is activated in the system controller and the corresponding use case has been selected.</p> <p><i>Parameters > System dimensioning > Heat generator > A Saunier Duval heat pump is available <yes></i> and <i>Parameters > System dimensioning > Heating circuit 1 > A heating circuit 1 is available for room heating <yes></i> and <i>Parameters > System dimensioning > Heating circuit 1 > The cooling function for circuit 1 is activated on the system controller <yes></i> and <i>Parameters > Use cases > Smart control > I would like to be able to configure hot water heating and heating (...) with time control <✓></i></p> <p>If a value outside the value range is written to this communication object, error code 7 is sent to communication object 12.</p>				

Object	Name	Direction	Data width	DP type	Flags (CRWTU)
 70	Heating circuit 1 – flow temperature	Read	2 bytes	9.001	CR-T-
Rubric:	Data type:		Temperature (°C)		
Function:	Displays the current flow temperature in heating circuit 1. Cycle time: max. 3 minutes Value range: 0-99 °C				
Description:	This communication object is visible when a heating circuit 1 and a heating circuit 2 is available and the corresponding use case has been selected. <i>Parameters > System dimensioning > Heating circuit 1 > A heating circuit 1 is available for room heating <yes></i> and <i>Parameters > System dimensioning > Heating circuit 2 > A heating circuit 2 is available for room heating <yes></i> and <i>Parameters > Use cases > Information > I would like to see the system status of my Saunier Duval system (...) <✓></i>				

Object	Name	Direction	Data width	DP type	Flags (CRWTU)
 71	Heating circuit 1 – setpoint flow temperature	Read	2 bytes	9.001	CR-T-
Rubric:	Data type:		Temperature (°C)		
Function:	Displays the current setpoint flow temperature in heating circuit 1. Cycle time: max. 3 minutes Value range: 0-99 °C				
Description:	This communication object is visible when a heating circuit 1 is available and the corresponding use case has been selected. <i>Parameters > System dimensioning > Heating circuit 1 > A heating circuit 1 is available for room heating <yes></i> and <i>Parameters > Use cases > Information > I would like to see the system status of my Saunier Duval system (...) <✓></i>				

Object	Name	Direction	Data width	DP type	Flags (CRWTU)
 72	Heating circuit 1 – pump	Read	1 bit	1.011	CR-T-
Rubric:	Data type:		Status		
Function:	Displays the operating state of the pump in heating circuit 1. Cycle time: max. 3 minutes				
Description:	<p>This communication object is visible when a heating circuit 1 and a heating circuit 2 is available and the corresponding use case has been selected.</p> <p><i>Parameters > System dimensioning > Heating circuit 1 > A heating circuit 1 is available for room heating <yes></i> and <i>Parameters > System dimensioning > Heating circuit 2 > A heating circuit 2 is available for room heating <yes></i> and <i>Parameters > Use cases > Information > I would like to see the system status of my Saunier Duval system (...) <✓></i></p>				
Object	Name	Direction	Data width	DP type	Flags (CRWTU)
 73	Heating circuit 1 – heating curve	Read	2 bytes	9.031	CR-T-
Rubric:	Data type:		2-byte floating decimal value		
Function:	Displays the value of the setpoint heating curve parameter. Cycle time: max. 3 minutes Value range: 0.1-4				
Description:	<p>This communication object is visible when a heating circuit 1 is available and the corresponding use case has been selected.</p> <p><i>Parameters > System dimensioning > Heating circuit 1 > A heating circuit 1 is available for room heating <yes></i> and <i>Parameters > Use cases > Information > I would like to see the system status of my Saunier Duval system (...) <✓></i></p>				

Object	Name	Direction	Data width	DP type	Flags (CRWTU)
 74	Heating circuit 1 – minimum flow temperature cooling mode	Read	2 bytes	9.001	CR-T-
Rubric:	Data type: Temperature (°C)				
Function:	Displays the minimum flow temperature in cooling mode. Cycle time: max. 3 minutes Value range: 7-24 °C				
Description:	<p>The requirement for this is a heating circuit which has the cooling function activated and the corresponding use case has been selected.</p> <p><i>Parameters > System dimensioning > Heating circuit 1 > A heating circuit 1 is available for room heating <yes></i> and <i>Parameters > System dimensioning > Heating circuit 1 > The cooling function for circuit 1 is activated on the system controller <yes></i> and <i>Parameters > System dimensioning > Heat generator > A Saunier Duval heat pump is available <yes></i> and <i>Parameters > Use cases > Information > I would like to see the system status of my Saunier Duval system (...) <✓></i></p>				

Object	Name	Direction	Data width	DP type	Flags (CRWTU)
 75	Heating zone 2 – operation mode	Write	1 bytes	20.102	CRWT-
Rubric:	Data type:		HVAC mode		
Function:	<p>Sets and reads the operation mode of heating zone 2. You will find the assignment of KNX operation modes to the system controller in the table on page 42.</p> <p>For communication object 78, the assignment is set to the last "Standby" or "Economy" value sent.</p> <p>Cycle time: max. 35 seconds</p>				
Description:	<p>This communication object is visible when a heating circuit 2 is available and the corresponding use case has been selected.</p> <p><i>Parameters > System dimensioning > Heating circuit 2 > A heating circuit 2 is available for room heating <yes></i></p> <p>and</p> <p><i>Parameters > Use cases > Smart control > Any use case <✓></i></p>				

Object	Name	Direction	Data width	DP type	Flags (CRWTU)
 76	Heating zone 2 – "Auto" operation mode	Write	1 bit	1.011	CRWT-
Rubric:	Data type:		Status		
Function:	<p>Activates the "Auto" operation mode for heating zone 2 or shows whether this is active. Corresponds to "Auto" of data type HVAC mode.</p> <p>Cycle time: max. 35 seconds</p>				
Description:	<p>This communication object is visible when a heating circuit 2 is available and the corresponding use case has been selected.</p> <p><i>Parameters > System dimensioning > Heating circuit 2 > A heating circuit 2 is available for room heating <yes></i></p> <p>and</p> <p><i>Parameters > Use cases > Smart control > Any use case <✓></i></p>				

Object	Name	Direction	Data width	DP type	Flags (CRWTU)
 77	Heating zone 2 – "Day" operation mode	Write	1 bit	1.011	CRWT-
Rubric:		Data type:		Status	
Function:	<p>Activates the "Day" operation mode for heating zone 2 or shows whether this is active. Corresponds to "Economy" or "Standby" of data type HVAC mode. The last value written on communication object 75 is decisive for this state. "Economy" is used as standard.</p> <p>Cycle time: max. 35 seconds</p>				
Description:	<p>This communication object is visible when a heating circuit 2 is available and the corresponding use case has been selected.</p> <p><i>Parameters > System dimensioning > Heating circuit 2 > A heating circuit 2 is available for room heating <yes></i></p> <p>and</p> <p><i>Parameters > Use cases > Smart control > Any use case <✓></i></p>				

Object	Name	Direction	Data width	DP type	Flags (CRWTU)
 78	Heating zone 2 – "Night" operation mode	Write	1 bit	1.011	CRWT-
Rubric:		Data type:		Status	
Function:	<p>Activates the "Night" operation mode for heating zone 2 or shows whether this is active. Corresponds to "Comfort" of data type HVAC mode.</p> <p>Cycle time: max. 35 seconds</p>				
Description:	<p>This communication object is visible when a heating circuit 2 is available and the corresponding use case has been selected.</p> <p><i>Parameters > System dimensioning > Heating circuit 2 > A heating circuit 2 is available for room heating <yes></i></p> <p>and</p> <p><i>Parameters > Use cases > Smart control > Any use case <✓></i></p>				

Object	Name	Direction	Data width	DP type	Flags (CRWTU)
 79	Heating zone 2 – "Off" operation mode	Write	1 bit	1.011	CRWT-
Rubric:		Data type:		Status	
Function:	Activates the "Off" operation mode for heating zone 2 or shows whether this is active. Corresponds to "Building Protection" of data type HVAC mode. Cycle time: max. 35 seconds				
Description:	This communication object is visible when a heating circuit 2 is available and the corresponding use case has been selected. <i>Parameters > System dimensioning > Heating circuit 2 > A heating circuit 2 is available for room heating <yes></i> and <i>Parameters > Use cases > Smart control > Any use case <✓></i>				

Object	Name	Direction	Data width	DP type	Flags (CRWTU)
 80	Heating zone 2 – day temperature heating	Write	2 bytes	9.001	CRWT-
Rubric:		Data type:		Temperature (°C)	
Function:	Sets and reads the current setpoint value for the day temperature in heating zone 2. See note on page 42 for MiPro Sense Value range: 5-30 °C				
Description:	This communication object is visible when a heating circuit 2 is available and the corresponding use case has been selected. <i>Parameters > System dimensioning > Heating circuit 2 > A heating circuit 2 is available for room heating <yes></i> and <i>Parameters > Use cases > Smart control > I would like to be able to configure hot water heating and heating (...) with time control <✓></i> If a value outside the value range is written to this communication object, error code 7 is sent to communication object 12.				

Object	Name	Direction	Data width	DP type	Flags (CRWTU)
 81	Heating zone 2 – set-back temperature heating	Write	2 bytes	9.001	CRWT-
Rubric:	Data type:		Temperature (°C)		
Function:	Sets and reads the current setpoint value for the night temperature in heating zone 2. See note on page 42 for MiPro Sense Value range: 5-30 °C				
Description:	<p>This communication object is visible when a heating circuit 2 is available and the corresponding use case has been selected.</p> <p><i>Parameters > System dimensioning > Heating circuit 2 > A heating circuit 2 is available for room heating <yes></i> and <i>Parameters > Use cases > Smart control > I would like to be able to configure hot water heating and heating (...) with time control <✓></i></p> <p>If a value outside the value range is written to this communication object, error code 7 is sent to communication object 12.</p>				

Object	Name	Direction	Data width	DP type	Flags (CRWTU)
 82	Heating zone 2 – day temperature cooling	Write	2 bytes	9.001	CRWT-
Rubric:	Data type:		Temperature (°C)		
Function:	Sets and reads the current setpoint value for the day temperature cooling in heating zone 2. Cycle time: max. 35 seconds Value range: 15-30 °C				
Description:	<p>This communication object is visible if a Saunier Duval heat pump and a heating circuit 2 is available, the cooling function is activated in the system controller and the corresponding use case has been selected.</p> <p><i>Parameters > System dimensioning > Heat generator > A Saunier Duval heat pump is available <yes></i> and <i>Parameters > System dimensioning > Heating circuit 2 > A heating circuit 2 is available for room heating <yes></i> and <i>Parameters > System dimensioning > Heating circuit 2 > The cooling function for circuit 2 is activated on the system controller <yes></i> and <i>Parameters > Use cases > Smart control > I would like to be able to configure hot water heating and heating (...) with time control <✓></i></p> <p>If a value outside the value range is written to this communication object, error code 7 is sent to communication object 12.</p>				

Object	Name	Direction	Data width	DP type	Flags (CRWTU)
 85	Heating circuit 2 – flow temperature	Read	2 bytes	9.001	CR-T-
Rubric:	Data type:		Temperature (°C)		
Function:	Displays the current flow temperature in heating circuit 2. Cycle time: max. 3 minutes Value range: 0-99 °C				
Description:	This communication object is visible when a heating circuit 2 is available and the corresponding use case has been selected. <i>Parameters > System dimensioning > Heating circuit 2 > A heating circuit 2 is available for room heating <yes></i> and <i>Parameters > Use cases > Information > I would like to see the system status of my Saunier Duval system (...) <✓></i>				

Object	Name	Direction	Data width	DP type	Flags (CRWTU)
 86	Heating circuit 2 – setpoint flow temperature	Read	2 bytes	9.001	CR-T-
Rubric:	Data type:		Temperature (°C)		
Function:	Displays the current setpoint flow temperature in heating circuit 2. Cycle time: max. 3 minutes Value range: 0-99 °C				
Description:	This communication object is visible when a heating circuit 2 is available and the corresponding use case has been selected. <i>Parameters > System dimensioning > Heating circuit 2 > A heating circuit 2 is available for room heating <yes></i> and <i>Parameters > Use cases > Information > I would like to see the system status of my Saunier Duval system (...) <✓></i>				

Object	Name	Direction	Data width	DP type	Flags (CRWTU)
 87	Heating circuit 2 – pump	Read	1 bit	1.011	CR-T-
Rubric:	Data type:		Status		
Function:	Displays the operating state of the pump in heating circuit 2. Cycle time: max. 3 minutes				
Description:	<p>This communication object is visible when a heating circuit 2 is available and the corresponding use case has been selected.</p> <p><i>Parameters > System dimensioning > Heating circuit 2 > A heating circuit 2 is available for room heating <yes></i> and <i>Parameters > Use cases > Information > I would like to see the system status of my Saunier Duval system (...) <✓></i></p>				

Object	Name	Direction	Data width	DP type	Flags (CRWTU)
 88	Heating circuit 2 – heating curve	Read	2 bytes	9.031	CR-T-
Rubric:	Data type:		2-byte floating decimal value		
Function:	Displays the value of the setpoint heating curve parameter. Cycle time: max. 3 minutes Value range: 0.1–4				
Description:	<p>This communication object is visible when a heating circuit 2 is available and the corresponding use case has been selected.</p> <p><i>Parameters > System dimensioning > Heating circuit 2 > A heating circuit 2 is available for room heating <yes></i> and <i>Parameters > Use cases > Information > I would like to see the system status of my Saunier Duval system (...) <✓></i></p>				

Object	Name	Direction	Data width	DP type	Flags (CRWTU)
 89	Heating circuit 2 – minimum flow temperature cooling mode	Read	2 bytes	9.001	CR-T-
Rubric:	Data type: Temperature (°C)				
Function:	Displays the minimum flow temperature in cooling mode. Cycle time: max. 3 minutes Value range: 7– 24 °C				
Description:	<p>The requirement for this is a heating circuit which has the cooling function activated and the corresponding use case has been selected.</p> <p><i>Parameters > System dimensioning > Heating circuit 2 > A heating circuit 2 is available for room heating <yes></i></p> <p>and</p> <p><i>Parameters > System dimensioning > Heating circuit 2 > The cooling function for circuit 2 is activated on the system controller <yes></i></p> <p>and</p> <p><i>Parameters > System dimensioning > Heat generator > A Saunier Duval heat pump is available <yes></i></p> <p>and</p> <p><i>Parameters > Use cases > Information > I would like to see the system status of my Saunier Duval system (...) <✓></i></p>				

Object	Name	Direction	Data width	DP type	Flags (CRWTU)
 90	Heating zone 3 – operation mode	Write	1 bytes	20.102	CRWT-
Rubric:	Data type:		HVAC mode		
Function:	<p>Sets and reads the operation mode of heating zone 3. You will find the assignment of KNX operation modes to the system controller in the table on page 42. For communication object 93, the assignment is set to the last "Standby" or "Economy" value sent. Cycle time: max. 35 seconds</p>				
Description:	<p>This communication object is visible when a heating circuit 3 is available and the corresponding use case has been selected.</p> <p><i>Parameters > System dimensioning > Heating circuit 3 > A heating circuit 3 is available for room heating <yes></i></p> <p>and</p> <p><i>Parameters > Use cases > Smart control > Any use case <✓></i></p>				

Object	Name	Direction	Data width	DP type	Flags (CRWTU)
 91	Heating zone 3 – "Auto" operation mode	Write	1 bit	1.011	CRWT-
Rubric:	Data type:		Status		
Function:	<p>Activates the "Auto" operation mode for heating zone 3 or shows whether this is active. Corresponds to "Auto" of data type HVAC mode. Cycle time: max. 35 seconds</p>				
Description:	<p>This communication object is visible when a heating circuit 3 is available and the corresponding use case has been selected.</p> <p><i>Parameters > System dimensioning > Heating circuit 3 > A heating circuit 3 is available for room heating <yes></i></p> <p>and</p> <p><i>Parameters > Use cases > Smart control > Any use case <✓></i></p>				

Object	Name	Direction	Data width	DP type	Flags (CRWTU)
 92	Heating zone 3 – "Day" operation mode	Write	1 bit	1.011	CRWT-
Rubric:		Data type:		Status	
Function:	<p>Activates the "Day" operation mode for heating zone 3 or shows whether this is active. Corresponds to "Comfort" of data type HVAC mode. Cycle time: max. 35 seconds</p>				
Description:	<p>This communication object is visible when a heating circuit 3 is available and the corresponding use case has been selected.</p> <p><i>Parameters > System dimensioning > Heating circuit 3 > A heating circuit 3 is available for room heating <yes></i> and <i>Parameters > Use cases > Smart control > Any use case <✓></i></p>				

Object	Name	Direction	Data width	DP type	Flags (CRWTU)
 93	Heating zone 3 – "Night" operation mode	Write	1 bit	1.011	CRWT-
Rubric:		Data type:		Status	
Function:	<p>Activates the "Night" operation mode for heating zone 3 or shows whether this is active. Corresponds to "Economy" or "Standby" of data type HVAC mode. The last value written on communication object 90 is decisive for this state. "Economy" is used as standard. Cycle time: max. 35 seconds</p>				
Description:	<p>This communication object is visible when a heating circuit 3 is available and the corresponding use case has been selected.</p> <p><i>Parameters > System dimensioning > Heating circuit 3 > A heating circuit 3 is available for room heating <yes></i> and <i>Parameters > Use cases > Smart control > Any use case <✓></i></p>				

Object	Name	Direction	Data width	DP type	Flags (CRWTU)
 94	Heating zone 3 – "Off" operation mode Cycle time: max. 35 seconds	Write	1 bit	1.011	CRWT-
Rubric:		Data type:		Status	
Function:	Activates the "Off" operation mode for heating zone 3 or shows whether this is active. Corresponds to "Economy" or "Standby" of data type HVAC mode. The last value written on communication object 90 is decisive for this state. "Economy" is used as standard.				
Description:	<p>This communication object is visible when a heating circuit 3 is available and the corresponding use case has been selected.</p> <p><i>Parameters > System dimensioning > Heating circuit 3 > A heating circuit 3 is available for room heating <yes></i> and <i>Parameters > Use cases > Smart control > Any use case <✓></i></p>				

Object	Name	Direction	Data width	DP type	Flags (CRWTU)
 95	Heating zone 3 – day temperature heating	Write	2 bytes	9..001	CRWT-
Rubric:		Data type:		Temperature (°C)	
Function:	<p>Sets and reads the current setpoint value for the day temperature in heating zone 3. See note on page 42 for MiPro Sense Value range: 5-30 °C</p>				
Description:	<p>This communication object is visible when a heating circuit 3 is available and the corresponding use case has been selected.</p> <p><i>Parameters > System dimensioning > Heating circuit 3 > A heating circuit 3 is available for room heating <yes></i> and <i>Parameters > Use cases > Smart control > I would like to be able to configure hot water heating and heating (...) with time control <✓></i></p> <p>If a value outside the value range is written to this communication object, error code 7 is sent to communication object 12.</p>				

Object	Name	Direction	Data width	DP type	Flags (CRWTU)
 96	Heating zone 3 – set-back temperature heating	Write	2 bytes	9.001	CRWT-
Rubric:	Data type: Temperature (°C)				
Function:	Sets and reads the current setpoint value for the night temperature in heating zone 3. See note on page 42 for MiPro Sense Value range: 5-30 °C				
Description:	<i>Parameters > System dimensioning > Heating circuit 3 > A heating circuit 3 is available for room heating <yes></i> and <i>Parameters > Use cases > Smart control > I would like to be able to configure hot water heating and heating (...) with time control <✓></i> If a value outside the value range is written to this communication object, error code 7 is sent to communication object 12.				

Object	Name	Direction	Data width	DP type	Flags (CRWTU)
 97	Heating zone 3 – day temperature cooling	Write	2 bytes	9.001	CRWT-
Rubric:	Data type: Temperature (°C)				
Function:	Sets and reads the current setpoint value for the day temperature cooling in heating zone 3. Cycle time: max. 35 seconds Value range: 15-30 °C				
Description:	This communication object is visible if a Saunier Duval heat pump and a heating circuit 3 is available, the cooling function is activated in the system controller and the corresponding use case has been selected. <i>Parameters > System dimensioning > Heat generator > A Saunier Duval heat pump is available <yes></i> and <i>Parameters > System dimensioning > Heating circuit 3 > A heating circuit 3 is available for room heating <yes></i> and <i>Parameters > System dimensioning > Heating circuit 3 > The cooling function for circuit 3 is activated on the system controller <yes></i> and <i>Parameters > Use cases > Smart control > I would like to be able to configure hot water heating and heating (...) with time control <✓></i> If a value outside the value range is written to this communication object, error code 7 is sent to communication object 12.				

Object	Name	Direction	Data width	DP type	Flags (CRWTU)
 100	Heating circuit 3 – flow temperature	Read	2 bytes	9.001	CR-T-
Rubric:	Data type:		Temperature (°C)		
Function:	Displays the current flow temperature in heating circuit 3. Cycle time: max. 3 minutes Value range: 0-99 °C				
Description:	This communication object is visible when a heating circuit 3 is available and the corresponding use case has been selected. <i>Parameters > System dimensioning > Heating circuit 3 > A heating circuit 3 is available for room heating <yes></i> and <i>Parameters > Use cases > Information > I would like to see the system status of my Saunier Duval system (...) <✓></i>				

Object	Name	Direction	Data width	DP type	Flags (CRWTU)
 101	Heating circuit 3 – setpoint flow temperature	Read	2 bytes	9.001	CR-T-
Rubric:	Data type:		Temperature (°C)		
Function:	Displays the current setpoint flow temperature in heating zone 3. Cycle time: max. 3 minutes Value range: 0-99 °C				
Description:	This communication object is visible when a heating circuit 3 is available and the corresponding use case has been selected. <i>Parameters > System dimensioning > Heating circuit 3 > A heating circuit 3 is available for room heating <yes></i> and <i>Parameters > Use cases > Information > I would like to see the system status of my Saunier Duval system (...) <✓></i>				

Object	Name	Direction	Data width	DP type	Flags (CRWTU)
 102	Heating circuit 3 – pump	Read	1 bit	1.011	CR-T-
Rubric:	Data type:		Status		
Function:	Displays the operating state of the pump in heating circuit 3. Cycle time: max. 3 minutes				
Description:	<p>This communication object is visible when a heating circuit 3 is available and the corresponding use case has been selected.</p> <p><i>Parameters > System dimensioning > Heating circuit 3 > A heating circuit 3 is available for room heating <yes></i> and <i>Parameters > Use cases > Information > I would like to see the system status of my Saunier Duval system (...) <✓></i></p>				

Object	Name	Direction	Data width	DP type	Flags (CRWTU)
 103	Heating circuit 3 – heating curve	Read	2 bytes	9.031	CR-T-
Rubric:	Data type:		2-byte floating decimal value		
Function:	Displays the value of the setpoint heating curve parameter. Cycle time: max. 3 minutes Value range: 0.1-4				
Description:	<p>This communication object is visible when a heating circuit 3 is available and the corresponding use case has been selected.</p> <p><i>Parameters > System dimensioning > Heating circuit 3 > A heating circuit 3 is available for room heating <yes></i> and <i>Parameters > Use cases > Information > I would like to see the system status of my Saunier Duval system (...) <✓></i></p>				

Object	Name	Direction	Data width	DP type	Flags (CRWTU)
 104	Heating circuit 3 – minimum flow temperature cooling mode	Read	2 bytes	9.001	CR-T-
Rubric:	Data type: Temperature (°C)				
Function:	Displays the minimum flow temperature in cooling mode. Cycle time: max. 3 minutes Value range: 7-24 °C				
Description:	<p>The requirement for this is a heating circuit which has the cooling function activated and the corresponding use case has been selected.</p> <p><i>Parameters > System dimensioning > Heating circuit 3 > A heating circuit 3 is available for room heating <yes></i></p> <p>and</p> <p><i>Parameters > System dimensioning > Heating circuit 3 > The cooling function for circuit 3 is activated on the system controller <yes></i></p> <p>and</p> <p><i>Parameters > System dimensioning > Heat generator > A Saunier Duval heat pump is available <yes></i></p> <p>and</p> <p><i>Parameters > Use cases > Information > I would like to see the system status of my Saunier Duval system (...) <✓></i></p>				

Object	Name	Direction	Data width	DP type	Flags (CRWTU)
 201	Heat generator – flow temperature	Read	2 bytes	9.001	CR-T-

Rubric: Data type: Temperature (°C)

Function: Displays the heat generator's current flow temperature.
 Cycle time: max. 3 minutes
 Value range: 0-120 °C

Description: The minimum requirement for this is the installation of a Saunier Duval gas boiler and/or a Saunier Duval heat pump and selection of the corresponding use case.
Parameters > System dimensioning > Heat generator > A Saunier Duval gas boiler is available <yes>
 and/or
Parameters > System dimensioning > Heat generator > A Saunier Duval heat pump is available <yes>

You can configure up to eight heat generators.
 Each analogue communication object has an offset of 5.
 Example:
 Heat generator 1 has the communication object number 201
 Heat generator 2 has the communication object number 206

Object	Name	Direction	Data width	DP type	Flags (CRWTU)
 202	Heat generator – error	Read	1 bit	1.002	CR-T-
Rubric:		Data type:		Boolean	
Function:	Shows whether the heat generator has an error. Cycle time: max. 5.5 minutes True = Error exists				
Description:	<p>The minimum requirement for this is the installation of a Saunier Duval gas boiler and/or a Saunier Duval heat pump and selection of the corresponding use case.</p> <p><i>Parameters > System dimensioning > Heat generator > A Saunier Duval gas boiler is available <yes></i> and/or <i>Parameters > System dimensioning > Heat generator > A Saunier Duval heat pump is available <yes></i></p> <p>You can configure up to eight heat generators. Each analogue communication object has an offset of 5. Example: Heat generator 1 has the communication object number 202 Heat generator 2 has the communication object number 207</p>				

4 Commissioning

4.1 Operation

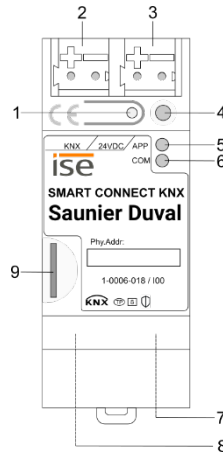

Figure 9: ise smart connect KNX Saunier Duval.

1	Programming button for KNX	Switches the device to the ETS programming mode or vice versa.	
2	KNX connection (twisted pair)	Left: (+ / red) Right: (- / black)	
3	Connection for power supply	DC 24 to 30 V, 2 W (at 24 V) Left: (+ / yellow) Right: (- / white)	
4	KNX programming LED (red)	Red: Device is in ETS programming mode Yellow: See 4.2.1 / 4.2.2 for start or diagnosis code	
5	LED APP (green)	Green: Normal operation Off / flashes: See 4.2.1 / 4.2.2 for start or diagnosis code	
6	LED COM (yellow)	Yellow: Normal operation (brief dark phases indicate KNX telegram traffic) Off / flashes: See 4.2.1 / 4.2.2 for start or diagnosis code	
7	Ethernet connection	LED 10/100 speed (green) On: 100 Mbit/s Off: 10 Mbit/s	LED link/ACT (orange) On: Connection to IP network Off: No connection Flashes: Data reception on IP
8	USB connection	USB connection type A establishes the connection to the system controller via the ise eBUS Adapter. Use the supplied USB cable as standard. Please note that the use of USB cables with a length of more than 3 m is generally not permitted.	
9	microSD card slot	Without function.	

4.2 LED status displays

The device features three status LEDs on the upper housing side and two status LEDs at the network connections.

The LED displays have **different meanings**

- while the device is starting and
- during operation.



4.2.1 LED status display upon device start-up

After the power supply (DC 24 V on the yellow-white connection terminal) is switched on or after a return in voltage occurs, the device indicates its status through the following LED combinations:

"APP" LED (green)	LED "COM" (yellow)	Meaning	
○ Off	○ Off	No power supply – Check connections and power supply.	✘
○ Off	● Yellow	Device starting up.	✓
● Green	○ Off	Error – KNX not connected.	✘
○.....● Green Flash slowly	● Yellow	The application has not been configured yet, e.g. not yet loaded with the ETS.	✘
● Green	● Yellow	Device booted up and ready for operation.	✓
○.....● Green Flash quickly	○ Off	Error – Please contact support. The firmware cannot be started.	✘
●...○...●...○...●... Green ○...●...○...●...○... Yellow Flash slowly in an alternating fashion		Error – Please contact support. The newly loaded firmware cannot be started. The system is trying to activate the previous firmware (invalid firmware).	✘

4.2.2 LED status display in operation

Once device start-up is complete, the meaning of the LEDs is as follows:

LED "APP" (green)	Meaning
● Green	<u>Normal operation</u>
○ Off	<u>Device in start-up procedure or out of operation:</u> Wait until the start-up for procedure is complete or check the power supply
 Flashes at approx. 1 Hz	<u>Error:</u> Application is not parametrised or not fully parametrised. Check the device parametrisation in the ETS and carry out an application download to the device.
 Three slow flashes followed by a 2 sec pause	<u>KNX Gateway error:</u> 3 = Error in communication with the ise eBUS Adapter. Communication between the ise smart connect KNX Saunier Duval and the ise eBUS Adapter is not possible via USB. 4 = eBUS cable not connected. eBUS connection not recognised.
 Five slow flashes followed by a 2 sec pause	<u>KNX Gateway error:</u> 1 = system controller not found. eBUS communication is possible, but no system controller was found.

LED "COM" (yellow)	Meaning
Yellow	<u>Normal operation:</u> KNX connection is established; no KNX telegram traffic.
Yellow with brief dark phases	<u>Normal operation:</u> KNX connection is established; KNX telegram traffic.
Off	<u>Error:</u> Connection to KNX is interrupted. Check the bus connection.

4.3 Accelerate transfer: Select transfer path *KNX-TP* or *IP*

Downloading (transmission from the ETS to the device) occurs in the programming environment of the ETS. An additional KNX data interface is not required for transfer (bus connection via bus connection terminal). The ETS can reach the device from both the IP page and the KNX TP page.

Due to considerably shorter transmission times, we recommend downloading from the device's IP page.

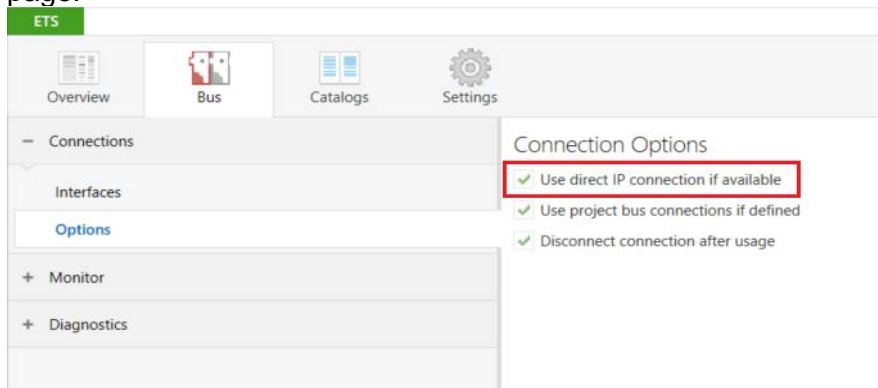

Figure 10: The “Use direct KNX-IP connection if available” setting accelerates transmission from the ETS to the device.

To transmit the ETS via the IP side, configure the setting

Use direct KNX-IP connection if available.

on the ETS start page → *Bus tab* → *Options entry*.

4.4 Downloading the individual address of the device

- Ensure that the device and bus voltage are switched on.
- Ensure that the programming LED (4) is not illuminated.
- Press programming button (1) briefly – Programming LED (4) lights up red.
- Download individual address using the ETS.

After a successful programming procedure,

- LED (4) will go out.
- The ETS shows the completed transfer with a green marking under *History* in the sidebar (normally at the right edge of the window).
- The ETS sets the commissioning tick on the device for "Adr" and "Cfg".

You can now note down the individual address on the device.

4.5 Transferring application programs and configuration data

After programming the individual address, the application program, parameter settings and group address connections can be transferred to the device.

A connection to the device can be further established via IP or KNX for this purpose.

- Select “*Download > Download application*” to do so. The download lasts around 10 seconds with a direct IP connection or about 35 seconds if using TP.
- After the download, please wait approx. 15 seconds while the device copies the data and installs the application.
- Commissioning is complete.

4.6 Factory reset

The following individual KNX address is pre-set in the factory: 15.15.255

Following the factory reset, the device behaves as in the state of delivery. The device is unconfigured. This is indicated by the slowly flashing green APP LED (5) after the device is started up.

4.6.1 Factory reset using the programming button on the device

The device can be reset to the factory settings through a sequence during start-up.

- Make sure that the device is switched off.
- Press and hold programming button (1) and switch on the device.
- Press and hold programming button (1) until the programming LED (4), the APP LED (5) and the COM LED (6) flash slowly simultaneously.
- Briefly release the programming button (1), then press and hold it again until the programming LED (4), the APP LED (5) and the COM LED (6) flash quickly simultaneously.
- The factory reset is being carried out; release programming button.
- The device need not be restarted following a factory reset.

The factory reset can be cancelled at any time by interrupting the sequence.

4.6.2 Factory reset using the website of the device

The factory reset can also be triggered from the website of the device.

- Call up the website of the device. For this purpose, double-click the icon of the device in the *Other Devices* area in the network environment.

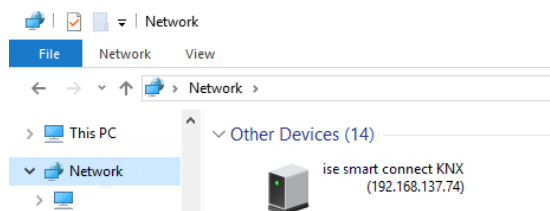

- Alternatively, you can also enter the IP address of the device in your browser.
- Select *Device status* in the upper menu bar on the website.
- Select *System > Factory reset* in the upper menu bar on the status page.
- Confirm the factory reset when the security prompt appears.
- The next displayed page *Factory reset* shows that the factory reset is being carried out. As soon as this is complete, the start page is loaded again.

4.7 Firmware update of the device

4.7.1 Firmware update using the device website

The ise smart connect KNX Saunier Duval makes it possible to install firmware updates using the device website. Select the *Firmware update* menu item under *System* on the device website to do so. The ise smart connect KNX Saunier Duval will now automatically search the update server for a newer version and show the current firmware version and the versions of any available updates. If a newer version is available, the associated description of the version is also displayed.

If the new firmware is incompatible with the configuration of the previous firmware, a corresponding message is displayed. A differentiation is made between the following cases here:

1. The new version provides new functionality. After the update, the device functions with the same range of functions as before. New functions cannot be used until an ETS download of a newer catalogue entry occurs.
2. The new version is completely incompatible with parametrisation in the version currently being used. An ETS download is absolutely necessary. We recommend unloading the ETS application program before the update and configuring the device with a new catalogue entry after the update.

The update can be started using the *Perform update* button. Should an incompatibility arise, the update must be confirmed again for security purposes.

4.7.2 Local firmware update without internet access

In addition to online updates, it is possible to carry out local updates without an internet connection. This is intended for devices which do not have an internet connection at their installation site and are only accessible via the local network. The firmware file can be selected locally using the *Choose File* button and then started using the *Perform update* button. In this case, the user is responsible for ensuring that the update is compatible (see chapter 4.7.3 "Compatibility of catalogue entry with firmware"). A downgrade to an older version is not possible.

4.7.3 Compatibility of catalogue entry with firmware

The version numbers in the catalogue entry and the firmware use an X.Y format. The main number, X, of the respective version indicates whether the catalogue entry and firmware are compatible. This is the case if both main numbers are identical. The second part of the version number, Y, is not relevant for compatibility. It simply indicates updates within the version.

If new firmware has a higher main number, it cannot be guaranteed that this version is compatible with an old ETS catalogue entry. For this reason, we recommend always unloading the application program from the device before the update and to then only use the new catalogue entry after that.

If the main numbers are the same, it may be necessary to use a new ETS catalogue entry for full functionality. However, this is not absolutely necessary if the new functions are not used in your project.

5 Technical data

5.1 ise smart connect KNX Saunier Duval

KNX medium	TP
Commissioning mode	S-Mode (ETS)
KNX supply	DC 21 to 30 V SELV
KNX connection	Bus connection terminal
External supply	
Voltage	DC 24...30 V $\pm 10\%$
Connection	Bus connection terminal, preferably yellow (+)/white (-)
Power consumption	typ. 1.2 W (with DC 24 V and connected ise eBUS Adapter) The device must be supplied with voltage by a dedicated power supply unit. Do not use the auxiliary voltage output of a KNX power supply unit which is also supplying a KNX line.
IP communication	Ethernet 10/100 BaseT (10/100 Mbit/s)
IP connection	1 x RJ45
USB connection	1 x USB type A Use the supplied USB cable as standard. Please note that the use of USB cables with a length of more than 3 m is generally not permitted.
Supported protocols	ARP, ICMP, IGMP, UDP/IP, DHCP, AutoIP KNXnet/IP as per KNX system specifications: Core, Device Management
microSD card	Without function
Ambient temperature	0 °C to +45 °C
Storage temperature	-25 °C to +70 °C
Installation width	36 mm (2 HP)
Installation height	90 mm
Installation depth	74 mm
Protection type	IP20 (compliant with EN60529)
Protection class	III (compliant with IEC 61140)
Test marks	KNX, CE

5.2 ise eBUS Adapter

Operating voltage	Supply via eBUS
eBUS connection	Connection terminal
USB connection	1 x mini USB B
eBUS power consumption:	0.1 W at 24 V
USB power consumption:	0.05 W
Ambient temperature	0 °C to +45 °C
Storage temperature	-25 °C to +70 °C
Installation width	17.5 mm (1 HP)
Installation height	90 mm
Installation depth	58 mm
Test marks	CE

6 Frequently asked questions (FAQ)

- **How can I find my ise smart connect KNX Saunier Duval's IP address?**
Please read about this in chapter 4.6.2 "Factory reset using the website of the device".
- **Are there software updates for my ise smart connect KNX Saunier Duval device?**
Please read about this in chapter 4.7 "Firmware update of the device". Please also visit www.ise.de/en/home for more information.
- **Why does the ETS report the error that it is not possible to write on a protected area when downloading the application program?**
Please ensure that your ETS version is up to date. The ise smart connect KNX Saunier Duval requires the current version of the ETS5.
- **Why is my ise smart connect KNX Saunier Duval restarting?**
After connecting the ise smart connect KNX Saunier Duval with the ise eBUS adapter, a restart may be necessary to initialise the eBUS connection.
- **What do I need to bear in mind if I replace the MiPro Sense controller?**
The setpoint value must be written on the data point of the communication objects *Day temperature heating (CO 65/80/95)* or *Set-back temperature heating (CO 66/81/96)* to ensure that the heating uses the required setpoint value after the system controller is replaced.

7 Troubleshooting and support

If you have a problem with your ise smart connect KNX Saunier Duval and require support, please send an e-mail with a detailed error description and the log file created after the error occurred to support@ise.de. Refer to Chapter 7.1 "Downloading log files if a problem occurs" for information on how to download the log files from your ise smart connect KNX Saunier Duval.

7.1 Downloading log files if a problem occurs

If a problem occurs, the log files are required for providing support. They can be downloaded via the website of the device (see chapter 4.6.2 "Factory reset using the website of the device"). To do so, proceed as follows:

- Call up the website of the device. For this purpose, double-click the icon of the device in the *Other Devices* area in the network environment.
- Select *System* in the upper menu bar on the website.
- Select *Download logfile*.
- The page which opens starts downloading the log files. If this does not occur, the provided link can be used.

7.2 Status page of the ise smart connect KNX Saunier Duval

You can call up the device status on the website of the ise smart connect KNX Saunier Duval (see chapter 4.6.2 "Factory reset using the website of the device"). Among other things, it displays the installed software version and the configuration and connection status in the ise smart connect KNX Saunier Duval. Should an error occur, please send us a screenshot of the status page.

7.3 The ise smart connect KNX Saunier Duval does not work

The following error tree is intended to solve the most common problems. Should this be unsuccessful, please contact us at support@ise.de.

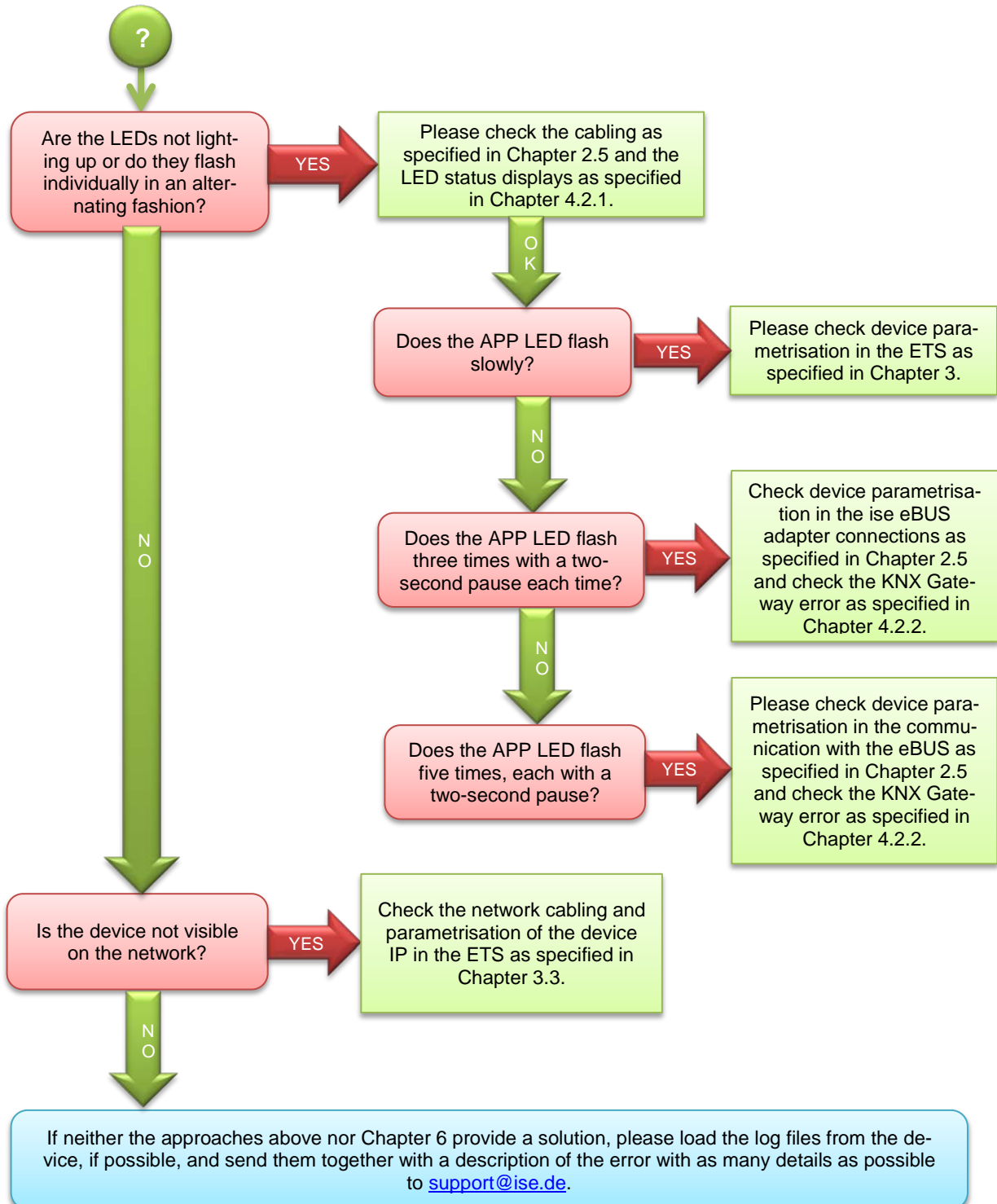

8 ise smart connect KNX Saunier Duval software licence agreement

Hereinafter are the contract terms for your use of the software as the "Licensee".

On accepting this agreement and installing the ise smart connect KNX Saunier Duval software or putting the ise smart connect KNX Saunier Duval into use, you conclude an agreement with ise Individuelle Software und Elektronik GmbH and agree to abide by the terms in this agreement.

8.1 Definitions

Licensor: ise Individuelle Software und Elektronik GmbH in Oldenburg, Osterstraße 15, Germany

Licensee: The legal recipient of the ise smart connect KNX Saunier Duval software.

Firmware: Software which is embedded on the ise smart connect KNX Saunier Duval hardware and enables operation of the ise smart connect KNX Saunier Duval.

ise smart connect KNX Saunier Duval software: The ise smart connect KNX Saunier Duval software designates all of the software provided for the ise smart connect KNX Saunier Duval product, including the operating data. This includes, in particular, the firmware and the product database.

8.2 Object of the agreement

The object of this agreement is the ise smart connect KNX Saunier Duval software provided on data media or through downloads, as well as the corresponding documentation in written and electronic form.

8.3 Rights of use of the ise smart connect KNX Saunier Duval software

The licensor grants the licensee the non-exclusive, non-transferable right to use the ise smart connect KNX Saunier Duval software for an unlimited time in accordance with the following conditions for the purposes and applications specified in the valid version of the documentation (which shall be provided in printed format or also as online help or online documentation).

The licensee is obliged to ensure that each person who uses the program only does so as part of this license agreement and observes this license agreement.

8.4 Restriction of rights of use

8.4.1 Copying, modification and transmission

The Licensee is not authorised to use, copy, modify or transfer the ise smart connect KNX Saunier Duval software in whole or in part in any way other than as described herein. Excluded from this is one (1) copy produced by the Licensee exclusively for archiving and backup purposes.

8.4.2 Reverse engineering and conversion technologies

The licensee is not authorised to apply reverse-engineering techniques to the ise smart connect KNX Saunier Duval software or to convert the ise smart connect KNX Saunier Duval software into another format. Such techniques include, in particular, disassembly (conversion of the binary-coded computer instructions of an executable program into an assembler language which can be read by humans) or decompilation (conversion of binary-coded computer instructions or assembler instructions into source code in the form of high-level language instructions).

8.4.3 Firmware and hardware

The firmware may only be installed and used on the hardware (ise smart connect KNX Saunier Duval) approved by the Licensor.

8.4.4 Transfer to a third party

The ise smart connect KNX Saunier Duval software may not be passed on to third parties, nor may it be made accessible to third parties.

8.4.5 Renting out, leasing out and sub-licensing

The Licensee is not authorised to rent or lease the ise smart connect KNX Saunier Duval software or grant sub-licenses to the program.

8.4.6 Software creation

The Licensee requires written approval from the Licensor to create and distribute software which is derived from the ise smart connect KNX Saunier Duval software.

8.4.7 The mechanisms of license management and copy protection

The mechanisms of the license management and copying protection of the ise smart connect KNX Saunier Duval software may not be analysed, published, circumvented or disabled.

8.5 Ownership, confidentiality

8.5.1 Documentation

The ise smart connect KNX Saunier Duval software and its documentation (which shall be provided in printed format or also as online help or online documentation) are business secrets of the licensor and/or the object of copyright and/or other rights and shall continue to belong to the licensor. The Licensee shall observe these rights.

8.5.2 Transfer to a third party

Neither the software, the data backup copy nor the documentation (which shall be provided in printed format or also as online help or online documentation) may be passed on to third parties at any point in time, in whole or in part, for a fee or free of charge.

8.6 Changes, additional deliveries

The ise smart connect KNX Saunier Duval software and the documentation (which shall be provided in printed form or additionally as online help or online documentation) shall be subject to possible changes by the licensor.

8.7 Warranty

The ise smart connect KNX Saunier Duval software shall be delivered together with software from third parties as listed in chapter "9 – Open Source Software". No warranty is provided for software from third parties.

8.7.1 Software and documentation

The ise smart connect KNX Saunier Duval software and the documentation (which shall be provided in printed form or additionally as online help or online documentation) shall be provided to the licensee in the respective valid version. The warranty period for the ise smart connect KNX Saunier Duval software is 24 months. The licensor shall provide the following warranty during this time:

- The software shall be free of material and manufacturing defects when turned over to the customer.
- The software shall function in accordance with the documentation included with it in the respective valid version.
- The software shall be executable on the computer stations specified by the Licensor.

The warranty shall be fulfilled with the supply of spare parts.

8.7.2 Limitation of warranty

No warranty shall be provided for the freedom from errors for the ise smart connect KNX Saunier Duval software and its data structures. Nor does the warranty cover defects due to improper use or other causes outside the influence of the licensor. Any additional warranty claims shall be excluded.

8.8 Liability

The Licensor shall not be liable for damages due to loss of profit, data loss or any other financial loss resulting from use of the ise smart connect KNX Saunier Duval software, even if the Licensor is aware of the possibility of such damage.

This limitation of liability is valid for all the Licensee's damage claims, regardless of the legal basis. In any case, liability is limited to the purchase price of the product.

The exclusion of liability does not apply to damage caused with intent or through gross negligence on the part of the licensor. Furthermore, claims based on the statutory regulations for product liability shall remain intact.

8.9 Applicable law

This agreement is subject to the laws of the Federal Republic of Germany.
The place of jurisdiction is Oldenburg.

8.10 Termination

This agreement and the rights granted herein shall end if the licensee fails to fulfil one or more provisions of this agreement or terminates this agreement in writing. The supplied ise smart connect KNX Saunier Duval software and the documentation (which is provided in printed form or also as online help or online documentation), including all copies, shall be returned immediately in such a case without the Licensor specifically requesting their return. No claim to reimbursement of the price paid shall be accepted in such a case.

The license to use the ise smart connect KNX Saunier Duval software shall expire upon termination of the agreement. The ise smart connect KNX Saunier Duval product must be taken out of operation in such a case. Further use of the ise smart connect KNX Saunier Duval without a license is precluded. The commissioning and visualisation software must be uninstalled and all copies must be destroyed or returned to the licensor.

8.11 Subsidiary agreements and changes to the agreement

Subsidiary agreements and changes to the agreement shall only be valid in writing.

8.12 Exception

All rights not expressly mentioned in this agreement are reserved.