

Product Manual

SMART CONNECT KNX e-charge II

1-000F-003



Documentation valid for:

Product database entry:	from v1.5
Firmware:	v1.3
Documentation issued:	09.11.2022

Legal Information

SMART CONNECT KNX e-charge II Product Manual
Status: 09.11.2022

ise Individuelle Software und Elektronik GmbH
Osterstraße 15
26122 Oldenburg, Germany
© Copyright 2022 ise Individuelle Software und Elektronik GmbH

All rights reserved. No part of this document may be edited, copied, disseminated or made public in any form (print, photocopy or any other method) without the prior written permission of ise Individuelle Software und Elektronik GmbH.

Products to which reference is made in this document can be either brands or registered trademarks of the respective rights holder. ise Individuelle Software und Elektronik GmbH and the author make no claim to these brands. The brands are named solely for the purpose of providing the necessary description.

Trademark

KNX is a registered trademark of the KNX Association.

Feedback and information about products



If you have any questions regarding our products, please contact us via e-mail at sales@ise.de. We would be pleased to receive your ideas, suggestions for improvements and criticism via e-mail at support@ise.de.

Contents

1	About this Documentation	3
1.1	Target group.....	3
1.2	Symbols and typographical conventions	3
2	About SMART CONNECT KNX e-charge II.....	4
2.1	Proper use	4
2.2	System.....	5
2.3	Functions.....	5
3	Important notes.....	9
3.1	General safety instructions	9
3.2	Storage and transport.....	9
3.3	Cleaning and maintenance	9
4	Technical data.....	10
5	Device design.....	12
5.1	Front	12
5.2	Data on device sticker	13
5.3	Top.....	13
5.4	Underside	14
5.5	Device side	14
6	Installation	15
6.1	Scope of supply	15
6.2	Checking the installation conditions	16
6.3	Mounting the device	17
7	Device website	22
7.1	Accessing the device website.....	22
7.2	Getting to know the interface of the device website	23
8	Commissioning and configuration	24
8.1	Reading device status using the LEDs	24
8.1.1	LEDs during device start-up	26
8.1.2	LEDs in operation.....	27
8.2	“APP” LED for faults	28
8.3	Configuration	28
8.3.1	Creating the device in the ETS.....	29
8.3.2	IP settings	31
8.3.3	Programming an individual address.....	32
8.3.4	Network settings via the device website.....	33
8.3.5	Resetting to factory settings.....	33
8.4	Update firmware	35
8.4.1	Updating the firmware via the device website.....	35
8.4.2	Compatibility between product database entry and firmware version	36
9	Parametrisation	38
9.1	Activating dynamic load management.....	39
9.2	Disabling dynamic load management.....	41
9.3	Connecting the electricity meter at the charging point.....	42
10	Group objects.....	44
10.1	General	44
10.2	DLM.....	46

10.3	Charging point 1 2 3 4 5.....	50
11	Troubleshooting.....	72
11.1	Faults after configuration.....	72
11.2	Generating log files.....	78
11.3	Contacting Support.....	78
11.4	FAQs - Frequently asked questions.....	79
12	Disassembly and Disposal.....	81
13	Glossary.....	83
14	Licence Agreement SMART CONNECT KNX e-charge II.....	86
14.1	Definitions.....	86
14.2	Object of the agreement.....	86
14.3	Software usage rights.....	86
14.4	Restriction of rights of use.....	86
14.4.1	Copying, modification and transmission.....	86
14.4.2	Reverse engineering and conversion technologies.....	86
14.4.3	Firmware and hardware.....	86
14.4.4	Transfer to a third party.....	87
14.4.5	Renting out, leasing out and sub-licensing.....	87
14.4.6	Software creation.....	87
14.4.7	The mechanisms of license management and copy protection.....	87
14.5	Software development.....	87
14.6	Property and confidentiality.....	87
14.6.1	Documentation.....	87
14.6.2	Transfer to a third party.....	87
14.7	Modifications and subsequent deliveries.....	87
14.8	Warranty.....	87
14.8.1	Software and documentation.....	88
14.8.2	Limitation of warranty.....	88
14.9	Liability.....	88
14.10	Applicable law.....	88
14.11	Termination.....	88
14.12	Subsidiary agreements and changes to the agreement.....	89
14.13	Exception.....	89
15	Open Source Software.....	90

1 About this Documentation

This documentation will accompany you through all phases of the product life cycle of SMART CONNECT KNX e-charge II. You will learn for example how to assemble, install, commission and configure the device.

All descriptions in this documentation relating to configuration in the ETS refer to the variant "ETS Professional" in version 5.

Explanations of KNX concepts do not form part of this documentation.

1.1 Target group

This documentation is aimed at qualified electricians and KNX processors.



Only qualified electricians may assemble and install the SMART CONNECT KNX e-charge II. Specialist knowledge of KNX is a prerequisite.



Anyone may configure the SMART CONNECT KNX e-charge II. We recommend that configuration is done by a system integrator with sound specialist knowledge of KNX and using the ETS.

1.2 Symbols and typographical conventions



Symbol / label	Meaning
	Warning of possible material damage
	General warning
	Warning of electrical voltage

Table 1: Symbols and safety notes



Symbol / label	Meaning
[F1]	PC button
<<Inscription>>	Text on software interface
	Troubleshooting tip
	Important additional information

Table 2: Special symbols and typographical conventions

2 About SMART CONNECT KNX e-charge II

2.1 Proper use

Via the SMART CONNECT KNX e-charge II, up to five compatible charging points can be integrated into the KNX system.

The SMART CONNECT KNX e-charge II is a KNX system device and complies with the KNX guidelines.



Important

ise Individuelle Software und Elektronik GmbH assumes no liability for damage caused by improper use or use for purposes other than or contrary to the intended purpose.

Installation: compatible charging points

The SMART CONNECT KNX e-charge II supports a wide range of models from many renowned manufacturers. Please see our [product page](#) for a list of compatible models.

Configuration: compatible ETS version

Simple integration into the KNX system (completely programmable via ETS):

- ETS5 from v5.7.5
- ETS6 from v6.0.2
- Product database entry: Download the product database entry from our website www.ise.de or from the ETS online catalogue free of charge.

KNX Secure



The SMART CONNECT KNX e-charge II is KNX Secure.

The device is compatible with KNX Secure. KNX Secure offers protection against manipulation in building automation and can be configured in the ETS project.

- The required KNX Secure certificate or the FDSK (Factory Default Setup Key) that it contains can be found on a sticker on the side of the device and is also enclosed with the device.
- For maximum security, we recommend removing the sticker from the device.
- Keep the certificate in a safe place.
- You cannot restore the certificate yourself.
- Please contact our support team if you lose the certificate despite utmost care.

2.2 System

The SMART CONNECT KNX e-charge II is connected to the KNX installation via KNX/TP. Depending on the model used, charging points are connected to the gateway either via IP or RS485 (Modbus). The SMART CONNECT KNX e-charge II unites the required connections in one gateway. Thanks to the integrated RS485 connection, no additional USB adapter is required.

Within the KNX installation, depending on the configuration, status information can be called up via a visualisation, for example, or actions can be triggered via a push button.

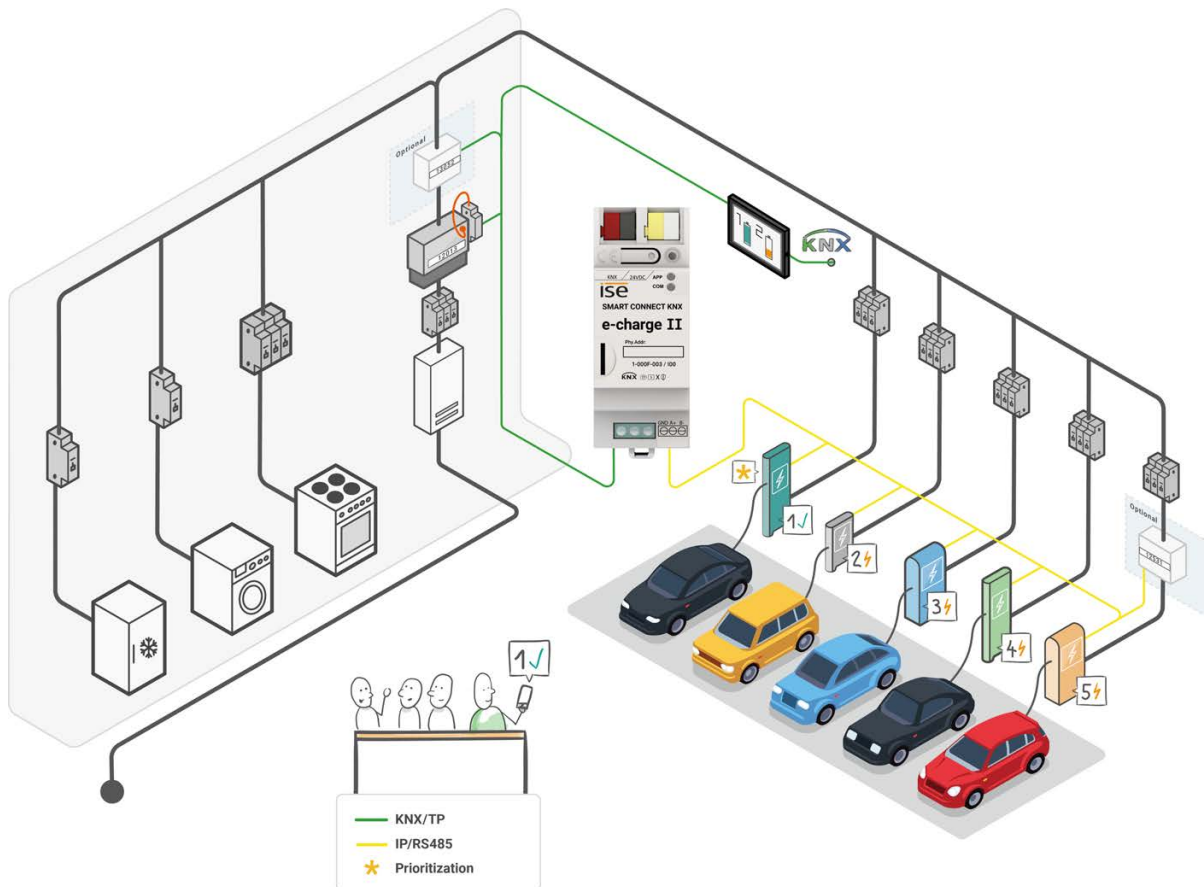

Figure 1: System SMART CONNECT KNX e-charge II

2.3 Functions

Integration of charging points

The gateway enables the integration of compatible charging points in your KNX system. Configuration is carried out entirely in the ETS. You do not require any additional software and have all data in one system.

- The installation and commissioning of charging stations may be subject to notification or approval from the grid operator. Therefore, please observe national regulations as well as the local regulations of the grid operator.
In Germany, a notification obligation exists pursuant to Section 19 of the Low Voltage Connection Ordinance (NAV).

Grid-supporting control

The SMART CONNECT KNX e-charge II enables the grid operator to control the power consumption if necessary by reducing the charging current or interrupting the charging process. Control or interruption of vehicle charging may occur during high load periods in order to prevent a critical grid situation.

Dynamic load management

The dynamic load management, or DLM for short, controls the current distribution without overloading the mains connection. The DLM coordinates the available charging current depending on the general charging current in the building. If consumption in the building decreases, more electricity is available for charging the electric vehicles at the charging points. This way, the DLM ensures the effective utilisation of power from the available mains connection. Despite various high power-consuming devices in the building, one or more electric vehicles can be charged at the same time. The DLM also offers the option of prioritising a charging point.

The two main factors for the use of the DLM are the use of an intelligent measuring system, e.g. a smart meter, and overcurrent protection device dimensioning.

Depending on the on-site conditions, a smart meter is recommended as the intelligent measuring system. If the installation already exists, an intelligent measuring system is implemented as follows:

- If an electromechanical meter is installed, a smart meter must also be connected.
- If an electronic household meter is installed, an interface with an optical head is used to read out and send the values to the KNX bus.

Smart meter and optical head interface requirements

- Communication at adjustable intervals
- Transmission of actual values (consumption values) measured in current or power
- KNX-capable

This documentation uses the term “smart meter” to refer to all types of intelligent measurement systems.

- The SMART CONNECT KNX e-charge II does not imply the function of a smart meter gateway.

The DLM is an optional function that can be used depending on the use case.

- ▶ See Activating dynamic load management, page 39.
- ▶ See Disabling dynamic load management, page 41.

Prioritisation of one charging point

Through the use of dynamic load management, you can prioritise one charging point. The electric vehicle at this charging point will be preferentially supplied with the largest possible charging current.

Charging points can only be prioritised via the ETS.

► See Activating dynamic load management, page 39.

Mixed operation

Up to five charging points from different manufacturers can be integrated in mixed operation. Mixed operation implies that you can install charging points with IP connection and RS485 connection (Modbus) together on one gateway.

○ IP connection



When integrating charging points with one IP connection, various models can be combined.

○ RS485 connection (Modbus)



When integrating charging points with an RS485 connection, only one model type can be used on the RS485 connection. In order to avoid communication problems, the following is also recommended: Do not install any additional devices on the RS485 bus line apart from the charging points that are to communicate with the SMART CONNECT KNX e-charge II.

Diverse statuses and actions

The SMART CONNECT KNX e-charge II offers various other functions, the implementation of which depends on the charging point model. See the overview on the [product page](#) for the full range of functions. More information on the individual functions

► See Group objects, page 44.

Electricity meter at the charging point

The SMART CONNECT KNX e-charge II supports the retrofitting of electricity meters at the charging point if the charging point does not offer the integrated measurement of consumption values (current, power and energy). Electricity meters with IP connection (Modbus TCP) and RS485 connection (Modbus) can be connected. To see which models are already pre-configured, please see our [product page](#).

Electricity meters not listed on the product page can also be connected via manual configuration.

Electricity meter requirements for manual configuration

- The electricity meter must provide phase-based registers for current and/or power values. At least one of the measurements is required.
- The measured values must be provided in 1, 2, or 4 consecutive 16-bit registers.

- To read the registers, the function codes 0x03 (read holding register) or 0x04 (read entry register) are required.
- If the electricity meter provides the measured values as floating-point numbers, they must be formatted in accordance with IEEE 754.
- If energy values are to be determined, the electricity meter must provide the registers either in a phase-based format or as a sum of all phases.
- If the electricity meter offers fault registers for the internal state, these must be provided as an integer.



Electricity meter with RS485 connection (Modbus)

The connection settings in the electricity meter must be adjusted to those of the charging point. Therefore, for Modbus RTU/ASCII, the following parameters must be configurable: Baud, data bits, parity and stop bit. The Modbus client address must also be configurable.

- ▶ See Connecting the electricity meter at the charging point, page 42.



Functional enhancements through firmware updates

You can obtain functional enhancements for the SMART CONNECT KNX e-charge II with a new version of the firmware. Simply download the latest firmware and the relevant product manual from our website www.ise.de.

- ▶ See Updating the firmware via the device website, page 35.

3 Important notes

3.1 General safety instructions

	Warning
	Danger from incorrect use <p>Incorrect use can result in damage to the device, fire or other dangers.</p> <ul style="list-style-type: none">• Only qualified electricians may install and mount electrical devices.• Follow the instructions in this product manual.• This product manual is part of the product and must remain with the customer.

3.2 Storage and transport

Store the device in its original packaging. The original packaging provides optimum protection during transport. Store the device in a temperature range of -25 °C to +70 °C.

3.3 Cleaning and maintenance

SMART CONNECT KNX e-charge II is maintenance-free.

If necessary, clean the device with a dry cloth.

	Important
	Device damage due to improper opening <ul style="list-style-type: none">• Never open the housing.• If you suspect that the device is damaged, contact our Support.• We provide a warranty in accordance with statutory requirements.• Send the device back to us postage free with a detailed error description only if our support team asks you to.

4 Technical data

Power supply and connections	
Rated voltage:	Supply via external DC 24 V to 30 V
Power consumption:	2.3 W
Connections:	<ul style="list-style-type: none"> • KNX: Bus connection terminal (black/red) • External power supply: Power supply terminal (white/yellow) • IP: 2x RJ45 (integrated switch) • RS485 (Modbus): Screw terminal, 3-pin (GND, A+, B-)
microSD card slot:	microSD cards up to 32 GB (SDHC)

Ambient conditions	
Installation environment temperature:	0 °C to +45 °C

Device dimensions	
Installation width:	36 mm (2 HP)
Installation height:	90 mm
Installation depth:	74 mm (DRA Plus)

KNX SPECIALIST	
Communication:	KNX/TP
Installation method:	S-Mode
Medium:	TP1-256
Current consumption:	typ. 6 mA

IP	
Communication:	Ethernet 10/100 BaseT (10/100 Mbit/s)

RS485	
Communication:	Modbus
Data rate:	max. 500 kbps
Cable length:	up to 1200 m
Electrical isolation:	3 kV DC
Termination:	120 Ω (can be activated)

Approvals and protection type

Approvals / certifications:	CE, KNX
Protection type:	IP20 (compliant with EN 60529)
Protection class:	III (compliant with IEC 61140)

Supported web browsers

Current versions of Mozilla Firefox, Microsoft Edge, Apple Safari and Google Chrome.

5 Device design

Stated directions always relate to the device in its installed position.

5.1 Front

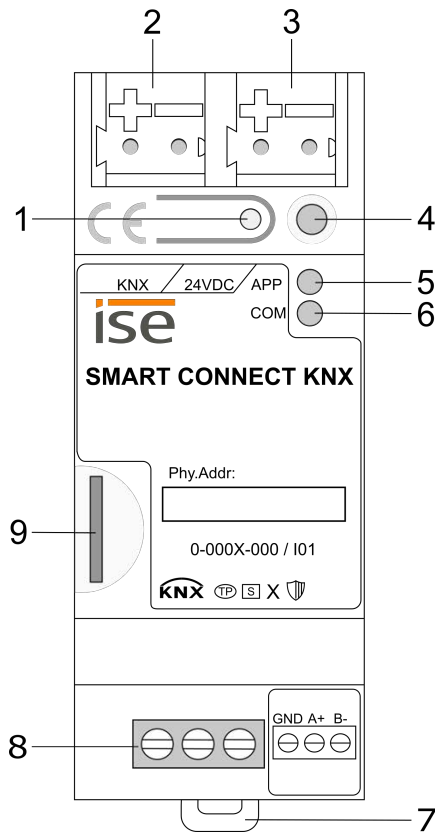

No.	Description	
1	Button:	Programming button
2	Connection:	KNX/TP
3	Connection:	External power supply
4	LED:	"Programming" (red)
5	LED:	"APP": Operation indication (green)
6	LED:	"COM": Communication KNX/TP (yellow)
7	Holding device:	Release lever for top-hat rail terminal
8	Connection:	RS485 (Modbus) screw terminal
9	Connection:	microSD card slot Use of microSD cards up to 32 GB (SDHC)

Figure 2: Front

5.2 Data on device sticker

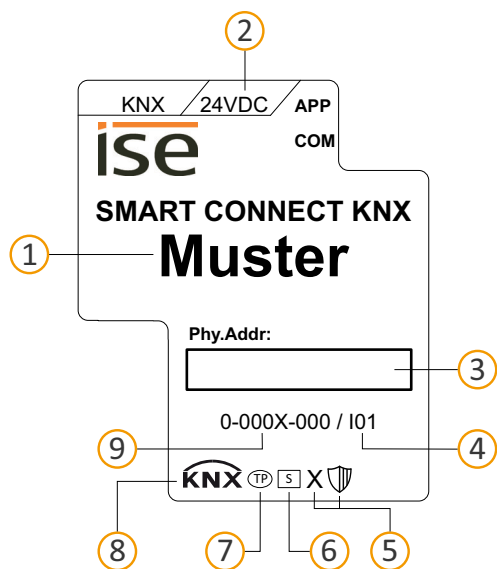

No.	Description
1	Product name
2	Rated voltage
3	Individual address: Enter the assigned individual address in the field with a permanent marker.
4	Index status
5	KNX Secure
6	Installation method, here "S mode"
7	Transfer medium, here "TP"
8	KNX certification
9	Order number

Figure 3: Device sticker

5.3 Top

The openings for securing the cover cap are located on the top of the device.

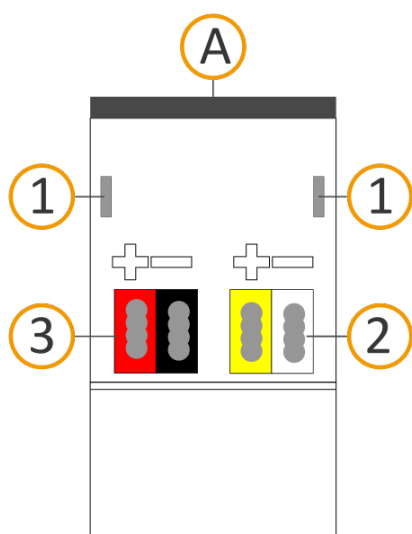

No./ Index	Description
1	Opening for securing the cover cap
2	Attached power connection terminal
3	Attached bus connection terminal
A	Back of device

Figure 4: Top of device

5.4 Underside

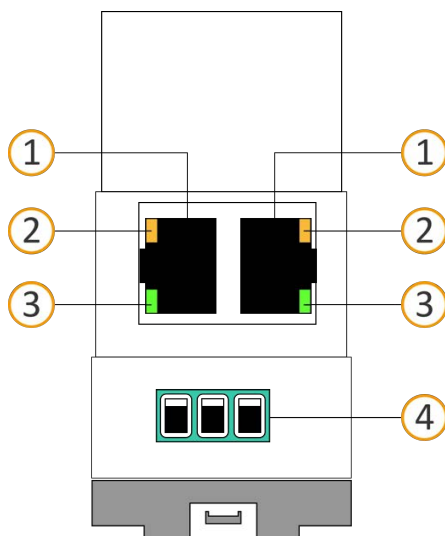

No.	Description
1	IP: 2x RJ45 (integrated switch)
2	"Communication" LED
3	"Connection speed" LED
4	RS485 (Modbus): screw terminal, 3-pin

Figure 5: Connections

5.5 Device side

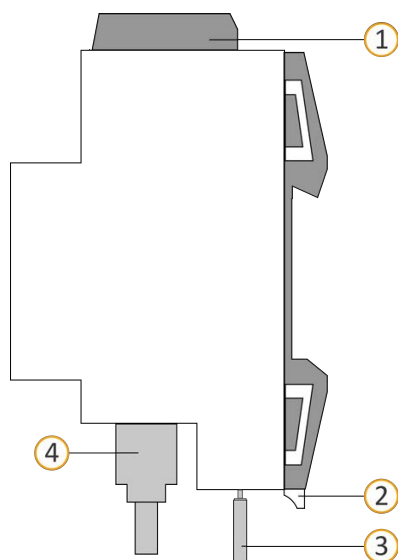

No.	Description
1	Attached cover cap
2	Release lever for top-hat rail terminal
3	RS485 communication cable (not included in the scope of supply) connected to 3-pin screw terminal.
4	RJ45 cable (not included in the scope of supply) connected to RJ45 socket.

Figure 6: Device side

6 Installation

6.1 Scope of supply

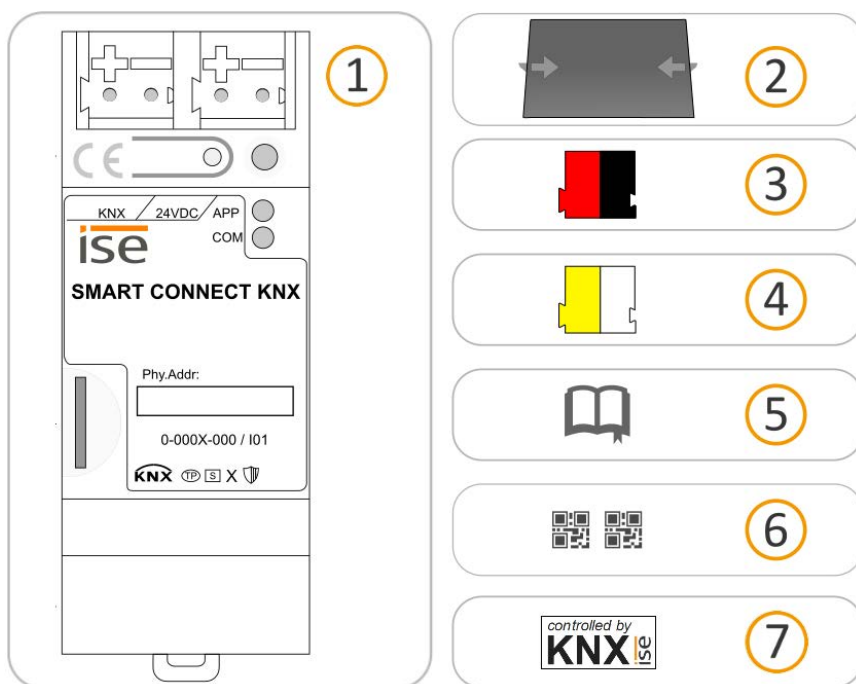



Figure 7: Scope of supply

No.	Objects supplied	Explanation
1	Device	SMART CONNECT KNX e-charge II
2	Cover cap	To protect connections from dangerous voltages.
3	Bus connection terminal	To connect the KNX/TP bus lines.
4	Power connection terminal	To connect the external power supply.
5	Installation instructions	This product manual also provides you with the information from the installation instructions but with additional details, application examples and configuration instructions.
6	Sticker set	Additional set of stickers with data for KNX Secure. The same stickers are attached to the side of the device.
7	5 x "controlled by KNX" stickers	Stickers to be attached to the charging point to identify it as a KNX controlled system after commissioning.

 The installation instructions are part of the product. Give these instructions to your customer.

6.2 Checking the installation conditions

Before starting the installation process, check that the requirements for the planned installation environment have been met.



Important

Device functional fault due to incorrect ambient temperature in the installation environment

- Pay attention to the temperature of the installation environment: min. 0 °C to max. 45 °C.
- Do not mount the SMART CONNECT KNX e-charge II above heat-emitting devices.
- Ensure that there is sufficient ventilation/cooling.

Pay attention to the device depth (see figure 8, item 1): DRA Plus, 74 mm.

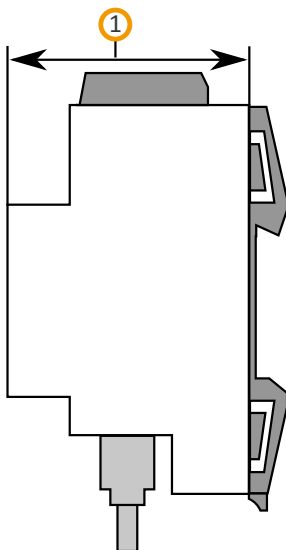

Figure 8: Device depth

6.3 Mounting the device

Only qualified electricians may assemble and install the SMART CONNECT KNX e-charge II. Specialist knowledge of the installation regulations is a prerequisite.



Warning



Danger from incorrect use

Incorrect use can result in damage to the device, fire or other dangers.

- Only qualified electricians may install and mount electrical devices.
- Follow the instructions in this product manual.
- This product manual is part of the product and must remain with the customer.



Warning

Danger of electric shock

An electric shock can result from touching live parts in the installation environment. Electric shock can cause death.

Pay attention to the installation regulations:

- Route the bus line with the sheathing intact until it is close to the bus connection terminal.
- Firmly press the bus line into the bus connection terminal as far as possible.
- Install bus line leads without sheathing (SELV) reliably disconnected from all non-safety low-voltage cables (SELV/PELV).
- Maintain the specified clearance.
- Attach the cover cap supplied.
- For more information, see also the VDE regulations governing SELV (DIN VDE 0100-410 / "Safe separation", KNX installation regulation).

Mounting and connecting the device

1. Snap the device vertically onto the top-hat rail (installation position: network connections at bottom).
2. Connect the KNX/TP bus line (referred to below as the bus line) to the KNX connection of the device (see figure 9, item 1) by means of the supplied bus connection terminal (see figure 9, item 2). Polarity: left/red: "+", right/black "-".
 - a. Attach the bus connection terminal (see figure 9, item 2).
 - b. Route the bus line with the sheathing intact until it is close to the bus connection terminal.
 - c. Firmly press the bus line into the bus connection terminal as far as possible.
 - d. Route the bus line to the back.

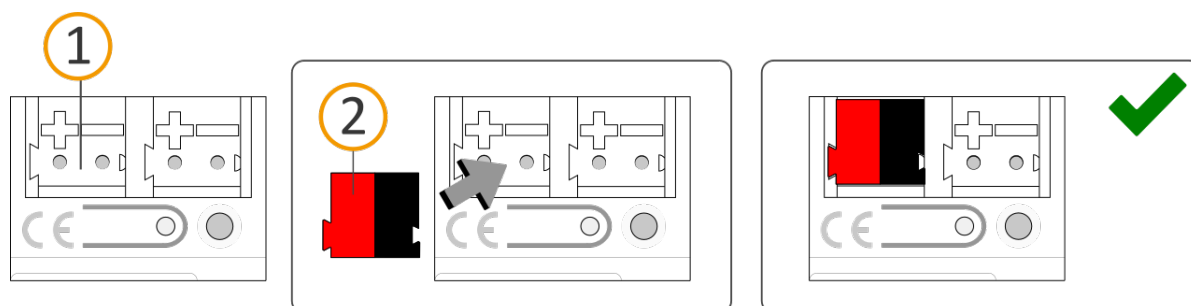

Figure 9: Connect the bus line

3. Connect the external power supply to the power supply terminal (see figure 10, item 1) by means of the supplied power connection terminal (see figure 10, item 2). Polarity: left/yellow: "+", right/white: "-".
 - a. Attach the power connection terminal (see figure 10, item 2).
 - b. Route the power line with the sheathing intact until it is close to the power connection terminal.
 - c. Firmly press the power line into the power connection terminal as far as possible.
 - d. Route the power supply line to the back.

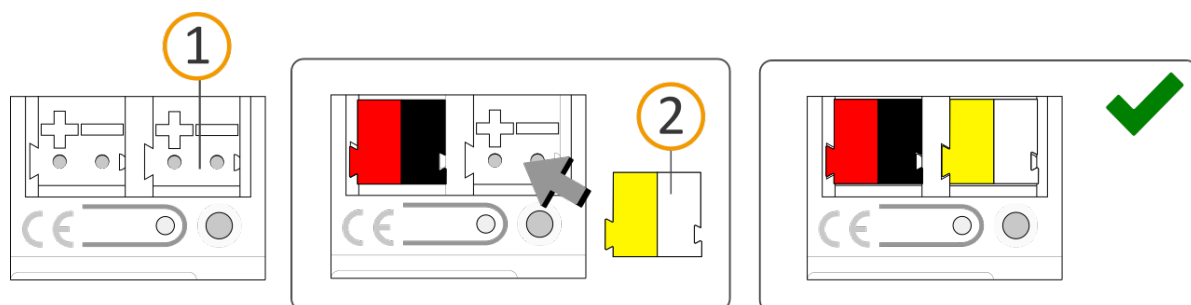

Figure 10: Connect the power supply



Important

Functional fault in all devices due to incorrectly dimensioned power supply

The following applies if you use the non-choked auxiliary supply output of a KNX power supply as an additional power supply:
The operating currents of all KNX/TP devices on the line section must not exceed the rated current of the power supply.

4. Attach the cover cap supplied:
 - a. Route all cables to the back. The openings for fastening the cover cap (see figure 11, item 1) must be clear. All cables must be between the openings.

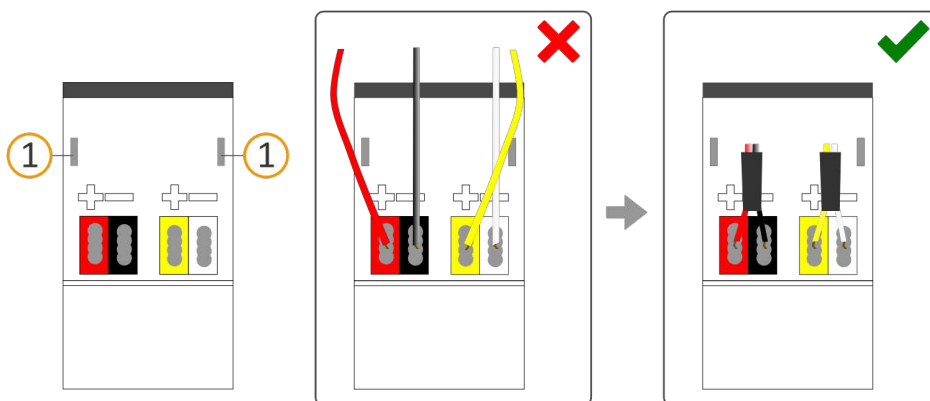

Figure 11: Cable routing

- b. Attach the cover cap over the connection terminals.
- c. Press the cover cap together gently.
- d. Route the cover cap's fastening claws into the openings until the cover cap noticeably engages.

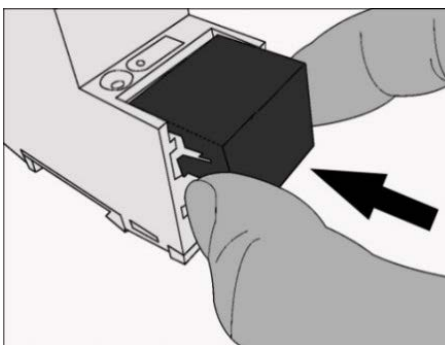

Figure 12: Attaching the cover cap

5. Connect the RS485 (Modbus) if a charging point is integrated via this connection.
 - a. Note the assignment of the 3-pin screw terminal.

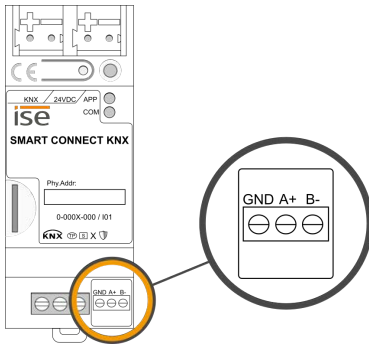

Figure 13: Screw terminal assignment

- b. Connect the RS485 communication cable conductors as per the assignment by inserting the lines into the conductor entry and tightening the screw terminal.

○ The GND connection is optional and may, depending on the system, reduce susceptibility to faults, e.g. communication interruptions.

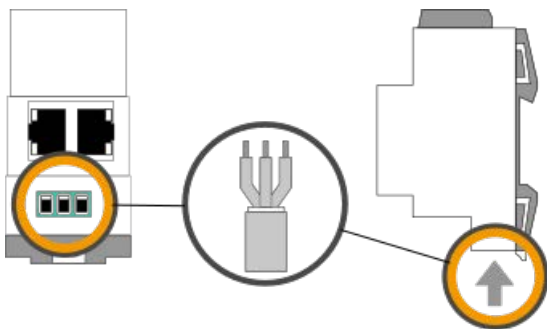

Figure 14: Connect RS485 communication cable

6. Connect the network:
 - a. make sure that your network infrastructure (router, DNS/DHCP server) is in operation.
 - b. The network connections are on the underside of the device.

- c. Connect the IP network cable (RJ45 cable) to the device's network connection (RJ45 socket).

- The RJ45 sockets are the same. The free RJ45 socket can be used to connect another IP device.

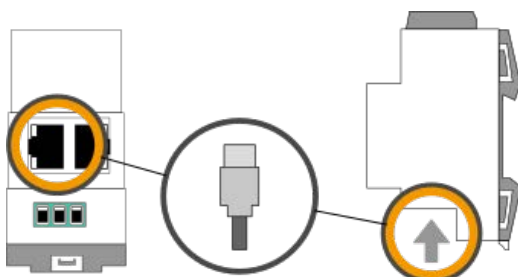

Figure 15: Connect the IP network cable

7 Device website

You can access the SMART CONNECT KNX e-charge II via the device website. The device website is run on your installed browser. You do not require any additional software. As soon as the device is available you can access the device website via the IP.

7.1 Accessing the device website

Call up the device website by actioning one of the following:

- Enter the device's IP address in the address bar of your browser.
- Alternatively, select the device in the network environment category <<Other devices>> (see figure 16, item 1): Double click on the device icon (see figure 16, item 2).

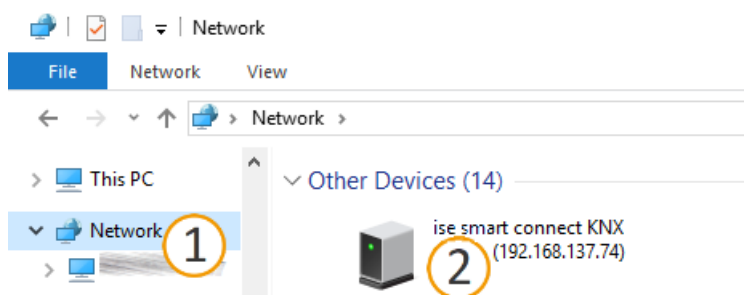

Figure 16: Accessing the device website via the network environment

7.2 Getting to know the interface of the device website

Figure 17: Device website start page

Item	Element	Function
1	Menu bar	Access other pages, log off, change language.
2	Page	The <<Status>> page is shown.
3	Information	Specific information and functions divided into sections.
4	Status bar	Open source licenses, currently installed firmware version.

Menu	Description
Status	<ul style="list-style-type: none"> System information on device and KNX General user information Information on configuration in the ETS
Settings	<ul style="list-style-type: none"> ▶ Generate log files, p. 78 Change password Restart device Reset device ▶ Reset to factory settings, p. 33 Switch device to programming mode ▶ Change logging mode, p. 78 ▶ Configure network settings, p. 33 Configure NTP settings ▶ Update firmware, p. 35

Table 3: Overview

8 Commissioning and configuration

After installing the device and connecting the bus, power supply and network, the device can be commissioned.

8.1 Reading device status using the LEDs

The following status indicators (LEDs) can be found on the front panel.

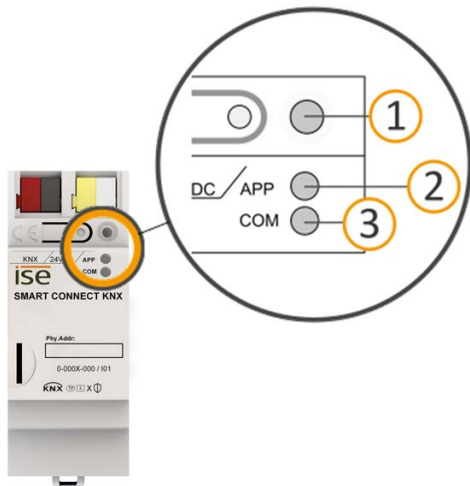

Figure 18: Status indicators (LEDs) on the front of the device

No.	Element	Description
1	"Programming" LED (red)	Programming mode active/inactive display
2	LED "APP" (green)	Serves as a status indicator for the application
3	LED "COM" (yellow)	KNX/TP communication traffic display

Table 4: Status indicators

The "Programming" LED shows, independently of the operating mode, whether the device is in programming mode or not.

Colour	Description
● (Red, continuously on)	Programming mode is active. ▶ Assign individual address, p. 32
○ (off)	Programming mode is deactivated.

Table 5: Device status – programming mode

The status indicators for the network are on the underside of the device.

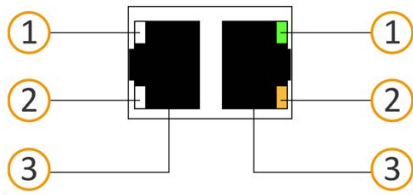

Figure 19: Network LEDs

No.	Element	Description
1	"Connection speed" LED	<ul style="list-style-type: none"> LED lights up green: 100 Mbit/s LED is off: 10 Mbit/s (There is no connection if LED 2 also off. Check whether the cable is correctly connected.)
2	"Communication" LED	<ul style="list-style-type: none"> LED lights up yellow-orange: connected but currently no telegram traffic LED flashes yellow-orange: telegram traffic
3	IP connection	2x RJ45 (integrated switch)

Table 6: Device status – network

8.1.1 LEDs during device start-up

The "APP" and "COM" LEDs have different meanings depending on the phase in the operating mode. After the power supply is switched on or after power returns, the device indicates its status using the following LED combinations:

APP	COM	Description
Correct operation		
○ (off)	● (yellow)	Device starting up.
● (green)	● (yellow)	Device started up and ready for operation.
Error		
○ (off)	○ (off)	No power supply. <ul style="list-style-type: none"> • Check the connections and the power supply.
○ ... ● ... ○ ... ● ... (off)...(green)...(off)...(green)... Slow flashing (approx. 1 Hz)	● (yellow)	The device is fully started up but is not yet configured. The system is configured in S mode. <ul style="list-style-type: none"> • Configure the device in the ETS.
○ ... ● ... ○ ... ● ... (off)...(green)...(off)...(green)... Slow flashing (approx. 1 Hz)	○ (off)	The device is fully started up but is not yet configured. The system is configured in S mode. <ul style="list-style-type: none"> • Configure the device in the ETS. Connection to KNX is interrupted. <ul style="list-style-type: none"> • Check whether the KNX and voltage connections are mixed up. • Check the bus connection. • Check whether the power supply is correctly connected.
○ . ● . ○ . ● . ○ . ● (off).(green).(off).(green).(off).(green) Rapid flashing	○ (off)	The firmware cannot be started. <ul style="list-style-type: none"> • Please contact Support.
○ ... ● ... ○ ... ● ... ● ... ○ ... ● ... ○ ... (off)...(green)...(off)...(green)... (yellow)...(off)...(yellow)...(off)... "APP" and "COM" LED: Slow flashing (approx. 1 Hz) in an alternating pattern		The newly loaded firmware cannot be started. The system is trying to activate the previous firmware (invalid firmware). <ul style="list-style-type: none"> • Please contact Support.

Table 7: Device status – device starting up

8.1.2 LEDs in operation

LED status after successful device start-up:

APP	Description
● (green)	The device is working perfectly (normal operation).
○ (off)	<p>The device is currently starting up or is out of operation.</p> <ul style="list-style-type: none"> • Wait until the device start-up process is complete. • If the device is still out of operation, check the connections and the power supply.

Table 8: "APP" LED in operation

COM	Description
● (yellow)	<p>The KNX connection has been established. No KNX telegram traffic. The LED is also deemed to be continuously on if brief irregular interruptions occur.</p>
○ . ● . ○ . ● . ○ . ● (off).(yellow).(off).(yellow).(off).(yellow) Rapid flashing	<p>KNX connection has been established. KNX telegram traffic.</p>
Error	
○ (off)	<p>Connection to KNX is interrupted.</p> <ul style="list-style-type: none"> • Check whether the KNX and voltage connections are mixed up. • Check the bus connection. • Check whether the power supply is correctly connected.

Table 9: "COM" LED in operation

8.2 “APP” LED for faults

The “App” LED indicates a fault with a corresponding flashing code. At the same time, the device website shows the corresponding error code. For more information on error codes and how to remedy faults, see chapter ► Troubleshooting, p. 72.

APP	Description
 <p>(off)...(green)...(off)...(green)...(off)...(green) Three slow flashes (approx. 1 Hz)</p>	<p>The device indicates a fault with a severity level of 60 to 110. This is a temporary fault that only affects a specific component and not the overall system operation. No new configuration in the ETS is required to remedy the fault.</p>
 <p>(off)...(green)...(off)...(green)...(off)...(green) Five slow flashes (approx. 1 Hz)</p>	<p>The device indicates a fault with a severity level of 120 to 130. This is a serious fault that puts the whole system out of operation. To remedy the fault, a new configuration in the ETS is required.</p>

Table 10: “APP” LED for faults

If several faults with different severity levels are present, the LED flashing code will always appear for the current fault with the highest severity level.

8.3 Configuration

The device is configured in the ETS (Engineering Tool Software). The ETS is available with various ranges of functions from the KNX Association (www.knx.org).

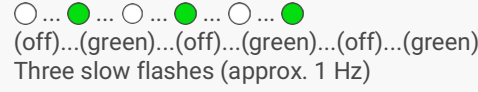
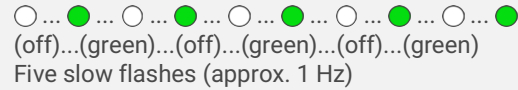
All descriptions in this documentation relating to configuration in the ETS refer to the variant “ETS Professional” in the version 5.



Help on the ETS is available in the integrated ETS Online Help.

- Press the [F1] button.

Work steps

1. Create SMART CONNECT KNX e-charge II as device in the ETS ► see Creating the device in the ETS, p. 29.
2. In the ETS, assign the device and its individual address corresponding to the KNX topology.
3. Select the option <<Receive IP address automatically>> or select <<Use a permanent IP address>> and complete the following fields: IP address, IP subnet mask and standard gateway address, ► see Setting the IP address, IP subnet mask and standard gateway address, p. 31.
4. Set the general parameters, ► see Parametrisation, p. 38.

5. Link the group addresses to the group objects.
6. SMART CONNECT KNX e-charge II is now ready for commissioning via <<Program ETS>> and for testing the functions.

8.3.1 Creating the device in the ETS

Depending on whether the product database entry already exists in the ETS catalogue or whether the device is already being used in your existing project, different work steps are required in order to use the current version.

Work steps	
Device already exists in the ETS catalogue?	
Yes	No
Update product database. During an update, the old product database entry is replaced by the new one.	Importing product database entry. There are numerous possibilities for importing a new product database entry. Below we will assume that you have downloaded the product database entry yourself. ▶ see Importing a new product database entry, p. 29.
Device in existing project should be updated?	
Yes	No
You must update the device properly so that the existing links to group addresses are maintained. ▶ see Updating a product in the existing project, p. 30.	Add the device to your topology in the usual way.

Table 11: Work steps – creating the device in the ETS

Importing a new product database entry

Requirement: You have downloaded the product database entry (product file) from our website at www.ise.de.

1. Start the ETS and select the <<Catalogue>> tab on the Start page.
2. Select the <<Import>> button in the toolbar.
3. In the <<Open product file>> window, open the product file and press on the <<Open>> button to confirm your selection.
4. Follow the further instructions in the ETS. If necessary, call up the Online Help with the [F1] button.

Updating a product in the existing project

Requirement: New product database entry exists in the catalogue.

1. In the ETS, open the project for which the device is to be updated.
2. Search for the new product database entry in the catalogue and add the new version of the device to the devices in your project.
3. Select the old version of the device in your topology.
4. Under <<Properties>>, select the <<Information>> → <<Application program>> tab.
5. Select the <<Update>> button under the item <<Update application program version>> (see figure 20, item 2)

○ If you change the value under <<Change application program>> (see figure 20, item 1), user-defined settings such as links to group addresses will be lost.

6. Select the newly added device and delete it again from your topology.

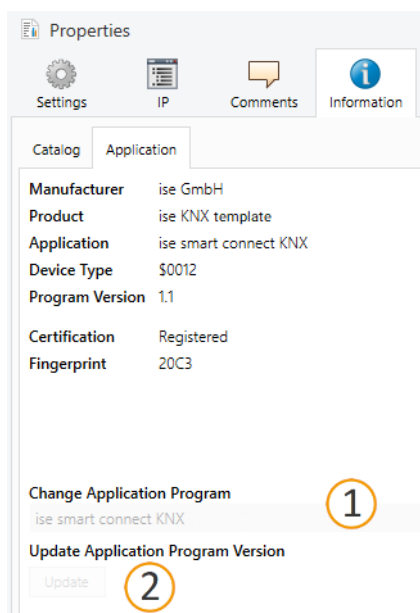

Figure 20: Updating the application program

8.3.2 IP settings

Besides the individual address in the KNX network, an IP address, the subnet mask and the address of the standard gateway in the IP data network must be assigned to the SMART CONNECT KNX e-charge II.

You can enter the settings manually in the ETS or receive them automatically (obtain the data from a DHCP server, e.g. integrated in the router of the data network).

Setting the IP address, IP subnet mask and standard gateway address

1. In the ETS, select the device in your topology.
2. Under <<Properties>> select the <<IP>> tab.
3. You will find the available selection options in figure 21 and table 12 “Settings for manual IP address entry or for receiving automatically”, p. 31.

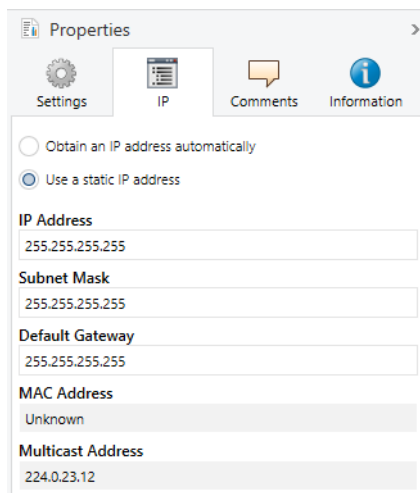

Figure 21: IP settings

Setting	Description
Receive IP address automatically	<p>The address data are automatically obtained from a DHCP server on the data network. The DHCP server must assign a valid IP address to the SMART CONNECT KNX e-charge II.</p> <p> If there is no DHCP server available, the device starts up after a waiting time with an automatic IP address in the address range of 169.254.1.0 to 169.254.254.255. As soon as a DHCP server is available, the device is automatically assigned a new IP address.</p>
Use a permanent IP address	<p>Enter the data manually. You can obtain the permitted IP address range and the subnet mask and standard gateway from the router configuration interface.</p>

Table 12: Settings for manual IP address entry or for receiving automatically

Serious misconfiguration

Default values are set if you want to use the setting <<Use permanent IP address>> but then forget to fill in the appropriate fields. Devices with the default value 127.001 as fixed IP address will therefore not start up properly.

Reset the device to its factory settings. ► Resetting to factory settings, p. 33.
If problems should persist, contact Support.

8.3.3 Programming an individual address

The individual address that you issued in the ETS must be assigned to the device. We refer here to "programming". To do this you must put the device into programming mode.

Assigning an individual address

Requirements: Device and bus voltage switched on. Programming LED is off.

1. Briefly press the programming button (see figure 22, item 1). The programming LED (see figure 22 item 2) lights up red.
2. In the ETS, assign the individual address to the device in accordance with the KNX topology and execute programming in the ETS.
3. On the device, enter the assigned individual address with a permanent marker in the field <<Phy.Addr.>>.

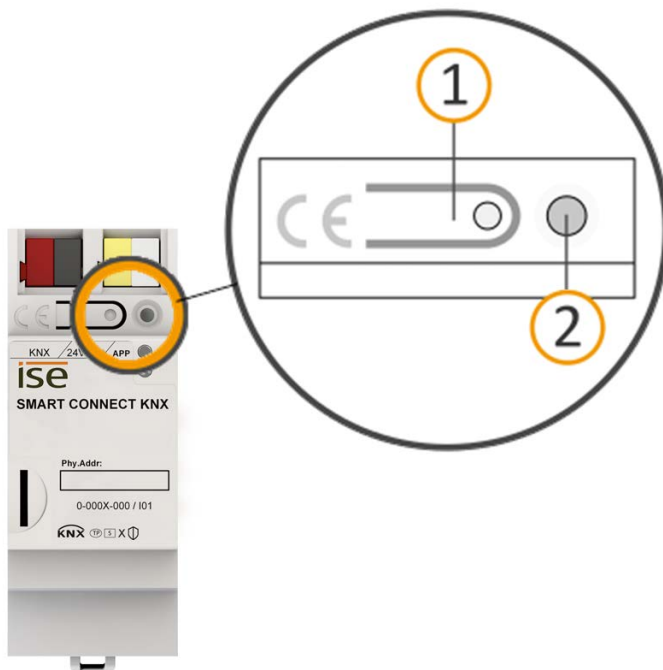

Figure 22: Programming

Recognising successful assignment of the individual address:

- Device: The programming LED on the device is off.
- ETS: The completed transfer is indicated on the <<History>> tab by a green marking. Programming flag <<Adr>> is set and <<Cfg>> is not set. More information about this and other flags is available from the ETS documentation.



After the IP address is assigned, you can also conveniently set the device to programming mode on the device website instead of pressing the programming button on the device itself.

8.3.4 Network settings via the device website

Requirement: the device website is open.

1. Select <<Settings>> in the menu bar.
2. In the <<Network>> area, select the  button under <<IPv4 settings>>. The network settings dialogue will open.
3. In the input field <<DNS address>>, enter the IP address of your DNS server.
4. Click <<Save>>. The system accepts the configuration.

8.3.5 Resetting to factory settings

When you reset the device to the factory settings, it behaves as if it were in the state of delivery. The device is then unconfigured:

- The device remains in the existing projects.
- The device keeps the version of the application program in the ETS.
- The entire parametrisation is rejected.
- The DHCP mode is activated.
- The device website password is reset to the initial password.
- The device now has the following as the individual address once more: 15.15.255.



An unconfigured device is identifiable by the green APP LED flashing slowly when the device starts up.
 ► See table 7 “Device status – device starting up”, p. 26.

You have the following possibilities for resetting the device to the factory settings:

- Manual: press the programming button on the device in a particular sequence.
- Automated: you select the <<Reset device>> button on the device website.



Warning

Danger of electric shock

An electric shock can result from touching live parts in the installation environment. Electric shock can cause death.

Pay attention to the installation regulations:

- Route the bus line with the sheathing intact until it is close to the bus connection terminal.
- Firmly press the bus line into the bus connection terminal as far as possible.
- Install bus line leads without sheathing (SELV) reliably disconnected from all non-safety low-voltage cables (SELV/PELV).
- Maintain the specified clearance.
- Attach the cover cap supplied.
- Also see also the VDE regulations governing SELV (DIN VDE 0100-410 / "Safe separation", KNX installation regulation) for more information.

Manually resetting the device to the factory settings

Requirement: the device must be switch off without voltage.

1. Press the programming button (see figure 22, item 1) and keep it pressed while you attach the power connection terminal.
2. Do not release the programming button until the following LEDs are all flashing slowly at the same time:
 - Programming LED (see figure 18, item 1)
 - APP LED (see figure 18, item 2)
 - COM LED (see figure 18, item 3)

Usual duration: approx. 30 seconds.

3. Release the programming button briefly.
4. Press the programming button again and keep it pressed until following LEDs are all flashing rapidly at the same time:
 - Programming LED (see figure 18, item 1)
 - APP LED (see figure 18, item 2)
 - COM LED (see figure 18, item 3)
5. Release the programming button.

The device is reset to the factory settings. You do not have to restart the device.

Resetting the device to the factory settings via the device website

1. Open the device website ► see Accessing the device website, p. 22.
2. On the <<Settings>> page, select the <<Reset device>> button.
3. Confirm the confirmation prompt.

As soon as the device has been completely reset to factory settings, the device website login will appear. To log in, you need to re-enter the Initial Device Password. You do not need to restart the device.

8.4 Update firmware

You can obtain functional enhancements for the SMART CONNECT KNX e-charge II with a new version of the firmware. The current firmware and corresponding product manual are available on our website at www.ise.de.

So that you can use the new functions, it is necessary for the versions of the firmware being used and the product database entry are compatible.

8.4.1 Updating the firmware via the device website

You can only import a firmware version that is newer than the current version on the device. Previous versions cannot be imported.

There are two ways to update:

- Online: Import firmware automatically online.
- Offline: Import firmware offline. For devices without internet connection in the installation environment.

No compatibility check

The system does not check whether the current configuration is compatible with the new firmware. You must check yourself whether the firmware is compatible with the product database entry.

► see Compatibility between product database entry and firmware version, p. 36.

Import firmware automatically online

1. Open the device website ► see Accessing the device website, p. 22.
2. Select <<Settings>> in the menu bar.
You will see the currently installed firmware version in the <<Firmware>> area. If a new firmware version is available for the device it will be indicated to you.
3. Under <<Online Update>>, select the <<Start update>> button.

Import firmware offline

Requirement: you have downloaded the current firmware version from www.ise.de.

1. Open the device website ► see [Accessing the device website](#), p. 22.
2. Select <<Settings>> in the menu bar.
3. In the <<Firmware>> area, select the <<Upload firmware>> button under <<Local update without internet access>>.
4. In Explorer, select the desired firmware file and confirm your selection with the <<Open>> button. The firmware is then installed automatically.

8.4.2 Compatibility between product database entry and firmware version

So that you can use the device's new functions, the version of the firmware used must be compatible with the version of the device's application program in the project. The application program is part of the product database entry.



The application program version can be found in the ETS under <<Properties>> in the <<Information>> tab → <<Application program>> under <<Program version>>.

Compatibility at a glance

The versions are fully compatible if the main version of the application program and firmware are identical.

The version numbers are structured according to the following scheme: <Main version no.>.<Sub-version no.>

Example: Full compatibility with same main version numbers

- Firmware version: 2.3
- Application program version: 2.0



In order to use all new functions, it may be necessary to update the application program, ► see [Updating a product in the existing project](#), p. 30.

Establishing compatibility

In case of incompatibility, you will need to uninstall the application program.

- The device remains in the existing projects.
- The device keeps the version of the application program in the ETS.
- The entire parametrisation is rejected.
- User data in the ETS is preserved.

Requirement: New product database entry exists in the catalogue.

1. In the ETS, open the project for which the device is to be updated.
2. Search for the new product database entry in the catalogue and add the new version of the device to your project.
3. Select the old version of the device in the topology for your project.
4. In the <<Topology>> window in the menu bar, select the <<Uninstall>> → <<Application program>> button.



After uninstalling, the device behaves as in the state of delivery. The device is then unconfigured. Then start configuration as usual. ► see "APP" LED for faults, p. 28.

5. Under <<Properties>>, select the <<Information>> → <<Application program>> tab.
6. Select the <<Update>> button under the <<Update application program version>>.
7. Select the newly added device and delete it again from your topology.

9 Parametrisation

The parameters you need to configure depend on your use case and charging point model. If you require an explanation of a parameter, use the context help in the ETS.

Calling up the context help in the ETS

1. Enable the <<Context help>> button in the <<Parameter>> tab in the toolbar.
2. Click on the desired parameter. The corresponding explanation appears in the lower area of the parameter dialogue.

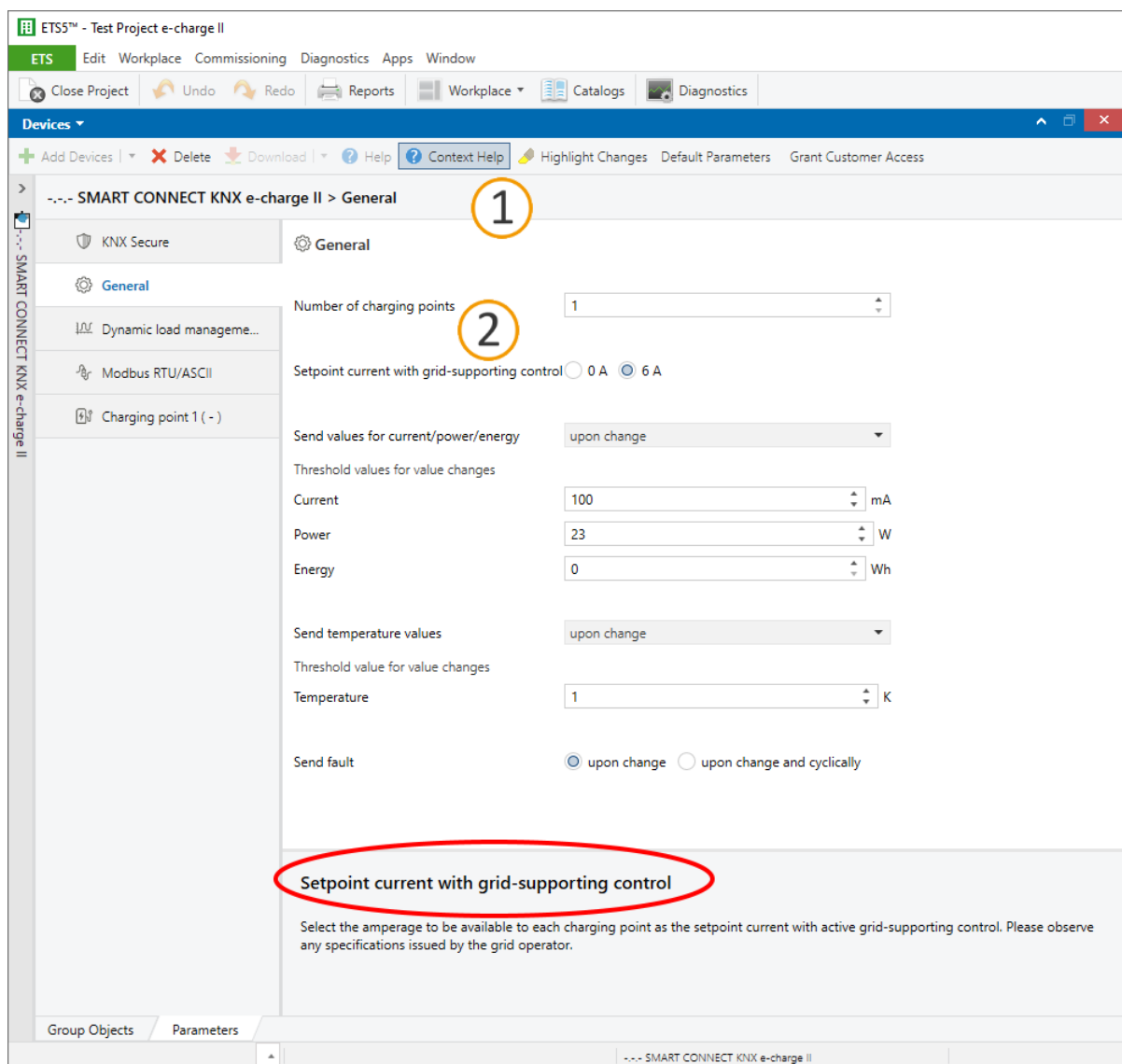

Figure 23: ETS context help

9.1 Activating dynamic load management

Use case

- Use the existing connection for charging electric vehicles in addition to the everyday devices in the building without overloading the connection and having to expand it.
- Charge several electric vehicles at the same time.

Overcurrent protection device and smart meter

The size of the overcurrent protection device is used by the DLM to calculate the maximum permissible current value that results, minus the load reserve. The load reserve prevents the total consumption from reaching the limit of the available current value, the value of the overcurrent protection device. In the DLM, the charging points and other devices share the maximum permissible current value.

The overcurrent protection device protects the line shared by the charging points and other devices. The smart meter has to measure the current flowing through this line. In doing so, the smart meter measures the current of all phases – either 1-phase or 3-phase, depending on the installation. The measurement represents a snapshot and the values are sent directly to the KNX bus. Using the measured values and the configuration stored in the ETS, the DLM determines how much current is available for charging.

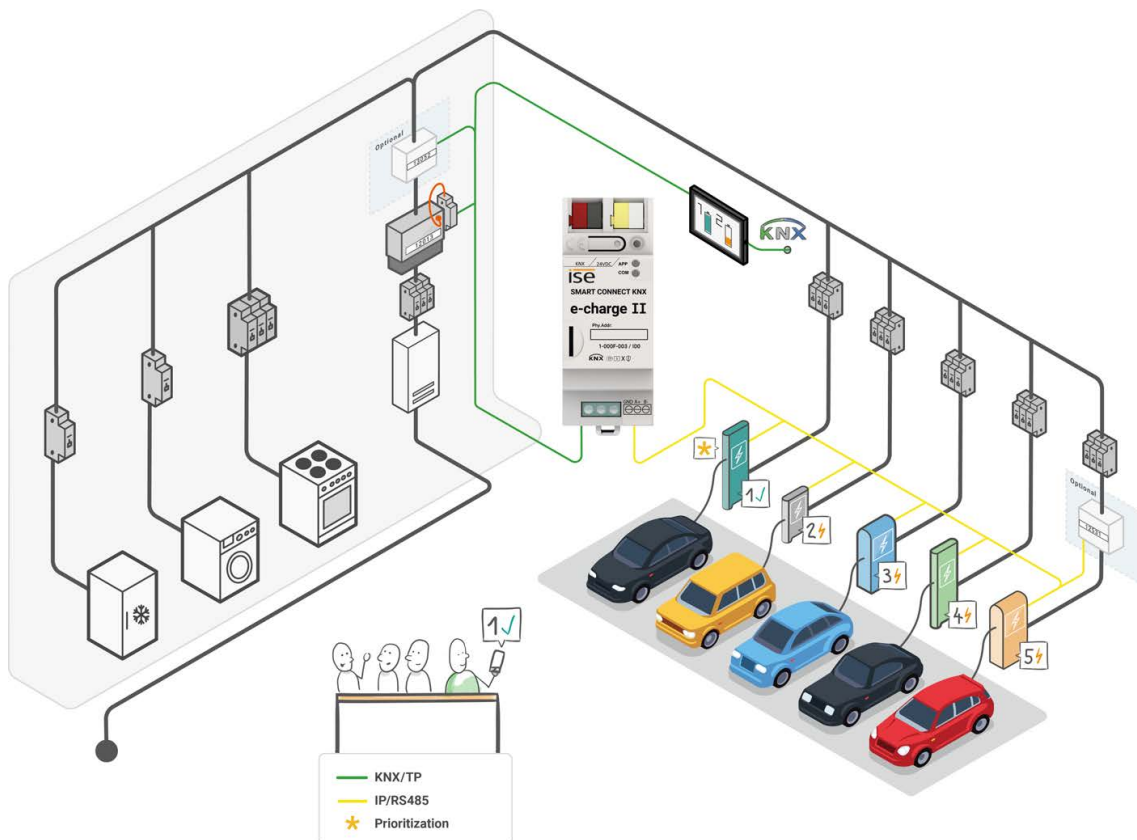



Figure 24: System SMART CONNECT KNX e-charge II

- The smart meter must measure that current of the line that is protected by the overcurrent protection device.

The DLM responds to load peaks and distributes the constantly changing, available current flexibly (dynamically) to the charging points in order to remain within the consumption limit. The DLM takes into account the defined minimum and maximum charging current of each charging point. If a high power-consuming device becomes active, the DLM reduces the charging current to the minimum charging current value and then slowly regulates the charging current upwards again in accordance with availability.

-  The minimum charging current per charging point is generally 6A. Consequently, the minimum charging current is added up when several charging points are in use. Regardless of the use of the DLM, the mains connection must at least be able to provide this total current value. In other words, the sum of the minimum charging currents of all charging points used must be below the maximum available current value.

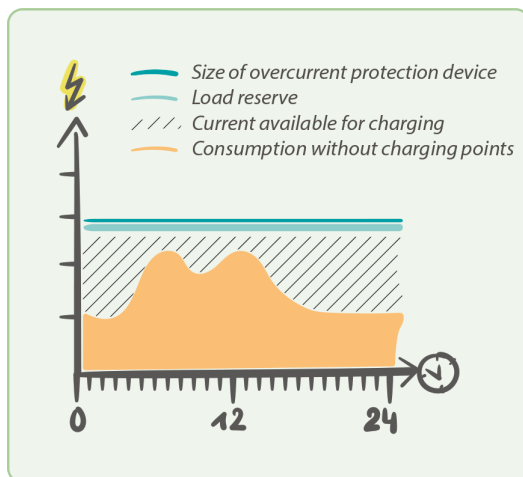

Figure 25: Dynamic load management

Activation

1. Activate the dynamic load management (DLM) under the like-named tab with <<on>>.
2. Define the overcurrent protection device and the load reserve.
3. If required, prioritise a charging point to which the DLM should provide the highest possible charging current as a preference.

The prioritised charging point is not included in the even distribution. If sufficient electricity is available for charging, all charging points will first be supplied with the minimum charging current that was defined per charging point. If more electricity is available, the prioritised charging point will receive it preferentially. The upper limit is the maximum charging current defined for the charging point. If there is still electricity available, it is distributed evenly amongst the other charging points.

4. Configure the smart meter.
 - a. Select the smart meter connection and the measurement in which the smart meter provides the consumption values.

These settings enable the corresponding group object to receive the measured values, see group objects 10-12 in chapter DLM, p. 46.

- b. Select the suitable measurement data point type.
- c. Select how the smart meter is to be checked for operation and connection to the KNX.

As well as sending measured values, there is also an additional query via the group object <<In operation>>, see table 21, p. 49. With the <<per measured values and "In operation" object>> setting, the measured values are no longer sent continuously, but rather only when there is a change. This reduces the bus load, which is increased due to the constant sending of measured values.

-  If the smart meter does not send any values within the specified time, a fault is reported. The DLM goes into emergency mode. This means that the DLM regulates distribution down to the minimum charging current per charging point.

- d. Set the time interval specified by the smart meter for sending the measured values.
5. Link the group addresses to the group objects.

The <<High power-consuming devices>> group object can cover several devices. Use either a group address that is shared by any number of KNX devices, or store several group addresses per KNX device, see table 20, p. 49.

9.2 Disabling dynamic load management

Use case

- The existing mains connection is sufficiently dimensioned not to require dynamic load management.
- External dynamic load management is used.
- There is no smart meter available.

Overcurrent protection device

If the DLM is disabled, the charging current is distributed via a current value defined per charging point. The values established for minimum and maximum charging current per charging point are taken into account.

-  The minimum charging current per charging point is generally 6A. Consequently, the minimum charging current is added up when several charging points are in use. Regardless of the use of the DLM, the mains connection must at least be able to provide this total current value. In other words, the sum of the minimum charging currents of all charging points used must be below the maximum available current value.

Deactivation

1. Disable the dynamic load management (DLM) under the like-named tab with <<off>>.

The parameters for the DLM are hidden and the corresponding group objects for the smart meter and high power-consuming devices are not available. Instead, the <<Setpoint charging current>> group object is enabled per charging point, see table 31, p. 56.

2. For each charging point, set the maximum charging current that may be used to charge the electric vehicle using the <<Setpoint charging current>> group object.

If the set value falls below the minimum charging current or exceeds the maximum charging current, the set value is automatically corrected to the value of the minimum or maximum charging current.

9.3 Connecting the electricity meter at the charging point

Use case

- The charging point does not offer an integrated electricity meter to measure consumption values.
- Measure the charging point's current consumption and send to the bus.
- Determine actual consumption in order to achieve an effective distribution of the available current.

Connection

The <<Electricity meter>> parameter is optional and is only available for charging points without an integrated electricity meter.

- If you are using a charging point without consumption value measurement with DLM, the provided setpoint current is automatically used as the actual current.

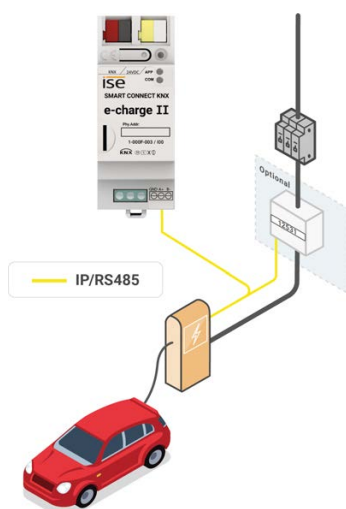

Figure 26: Electricity meter at the charging point

1. Add the electricity meter with <<Yes>>.

A new tab for electricity meter configuration will appear as a subcategory at the charging point.

2. Open the <<Electricity meter>> tab.

Depending on the charging point connection, you can choose from specific, pre-configured models or, in the case of manual configuration, the corresponding connections. To see which electricity meters are already pre-configured, please see our [product page](#).

3. Select the desired model or configure the electricity meter manually.

If you select a pre-configured model, the configuration is completed by entering the IP or Modbus client address.

For manual configuration, please refer to the electricity meter manufacturer's documentation and the context help in the ETS for parameter value specification.

▶ See "Calling up the context help in the ETS", p. 38.

10 Group objects

The SMART CONNECT KNX e-charge II makes the corresponding group objects available according to its range of functions. In addition to generally valid and DLM functions, there are model-dependent functions. The corresponding group objects appear as soon as you have assigned a manufacturer and model to the charging point.

The group objects are shown below according to the structure in the ETS. Model-dependent functions are referred to accordingly.

10.1 General

Group object 1	
Object function	Grid-supporting control
Details	<p>Reduces the charging current or interrupts the charging process as soon as the grid operator controls the power consumption. The charging current available during grid-supporting control is to be defined under the parameter <<Setpoint current with grid-supporting control>>.</p> <ul style="list-style-type: none"> • In its technical implementation, grid-supporting control with 0 A behaves in the same way as the <<Interruption>> function. When grid-supporting control is terminated, the previous state is always restored, taking into account the previously used setpoint current. However, if the setpoint current is changed during grid-supporting control, it will be subsequently recorded as the new setpoint value. • The 6 A setting acts upon the setpoint current to reduce the setpoint current to this value during grid-supported control. The previous state is restored as soon as the grid-supporting control is finished. However, if the setpoint current is changed during grid-supporting control, this setpoint value will be used once the grid-supporting control has ended. <p>The functions <<Grid-supporting control>> and <<Interruption>> can be used in parallel. The grid-supporting control settings 0 A and 6 A are not relevant. Interruption can be activated during grid-supporting control, for instance. Interruption is the more dominant of the functions and takes effect immediately. If interruption is cancelled and the grid-supporting control is still active, the charging point will return to the state of grid-supporting control again.</p>
Possible values	0: Off 1: On
Data width	1 bit
Data point type / data type	1.001/switch
Direction	Write
Flags (CRWTUI)	C-WTUI

Table 13: Grid-supporting control

Group object 2	
Object function	Grid-supporting control – state
Details	Shows whether grid-supporting control is active.
Possible values	0: inactive 1: active
Data width	1 bit
Data point type / data type	1.011/status
Direction	Read
Flags (CRWTUI)	CR-T--

Table 14: Grid-supporting control – state

Group object 8	
Object function	Fault
Details	Indicates whether a general fault is present.
Possible values	0: False (no fault present) 1: True (fault present)
Data width	1 bit
Data point type / data type	1.002/Boolean
Direction	Read
Flags (CRWTUI)	CR-T--

Table 15: Fault

Group object 9	
Object function	Last fault
Details	Shows information about the last or current fault.
Possible values	For details of the corresponding error code, see “General faults”, p. 73.
Data width	14 byte
Data point type/data type	16.001/character (ISO 8859-1)
Direction	Read
Flags (CRWTUI)	CR-T--

Table 16: Last fault

10.2 DLM

Group object 10	
Object function	Smart meter current value Smart meter current value L1 Smart meter power value Smart meter power value L1
Details	<p>Receives the value from the smart meter. Depends on the connection and measurement of the smart meter (<<Measurement>> and <<Connection>> parameters).</p> <ul style="list-style-type: none"> <<Smart meter current value>>: Actual current value with a 1-phase connected smart meter. <<Smart meter current value L1>>: Actual current value with a 3-phase connected smart meter. <<Smart meter power value>>: Actual power value with a 1-phase connected smart meter. <<Smart meter power value L1>>: Actual power value with a 3-phase connected smart meter. <p>The selection of the data point types depends on the measurement selected.</p>
Possible values	Electr. current (mA)/(A) Power (W)/(kW)
Data width	4 byte
Data point type/data type	<p>Electricity measurement: 7.012/electr. current (mA) 9.021/electr. current (mA, floating point) 14.019/electr. current (A, floating point)</p> <p>Power measurement: 9.024/power (kW, floating point) 14.056/power (W, floating point)</p>
Direction	Write
Flags (CRWTUI)	C-WTUI

Table 17: Smart meter, 1-phase/L1 – value

Group object 11	
Object function	Smart meter current value L2 Smart meter power value L2
Details	<p>Receives the value from the smart meter. Depends on the connection and measurement of the smart meter (<<Measurement>> and <<Connection>> parameters).</p> <ul style="list-style-type: none"> <<Smart meter current value L2>>: Actual current value with a 3-phase connected smart meter. <<Smart meter power value L2>>: Actual power value with a 3-phase connected smart meter. <p>The selection of the data point types depends on the measurement selected.</p>
Possible values	electr. current (mA)/(A) Power (W)/(kW)
Data width	4 byte
Data point type/data type	<p>Electricity measurement: 7.012/electr. current (mA) 9.021/electr. current (mA, floating point) 14.019/electr. current (A, floating point)</p> <p>Power measurement: 9.024/power (kW, floating point) 14.056/power (W, floating point)</p>
Direction	Write
Flags (CRWTUI)	C-WTUI

Table 18: Smart meter L2 – value

Group object 12	
Object function	Smart meter current value L3 Smart meter power value L3
Details	<p>Receives the value from the smart meter. Depends on the connection and measurement of the smart meter (<<Measurement>> and <<Connection>> parameters).</p> <ul style="list-style-type: none"> <<Smart meter current value L3>>: Actual current value with a 3-phase connected smart meter. <<Smart meter power value L3>>: Actual power value with a 3-phase connected smart meter. <p>The selection of the data point types depends on the measurement selected.</p>
Possible values	electr. current (mA)/(A) Power (W)/(kW)
Data width	4 byte
Data point type/data type	<p>Electricity measurement: 7.012/electr. current (mA) 9.021/electr. current (mA, floating point) 14.019/electr. current (A, floating point)</p> <p>Power measurement: 9.024/power (kW, floating point) 14.056/power (W, floating point)</p>
Direction	Write
Flags (CRWTUI)	C-WTUI

Table 19: Smart meter L3 – value

Group object 13	
Object function	High power-consuming devices
Details	<p>Receives the activity status from high power-consuming devices. If a high power-consuming device becomes active, the DLM reduces the charging current to the minimum charging current value. After a short waiting time, the DLM distributes the changed, available charging current. If another high power-consuming device reports within the short waiting time, the short waiting time starts again.</p> <p>You can group several current consumers together under the group object <<High power-consuming devices>>. Use either a group address that is shared by any number of KNX devices, or store several group addresses per KNX device.</p>
Possible values	0: False (inactive) 1: True (active)
Data width	1 bit
Data point type / data type	1.002/Boolean
Direction	Write
Flags (CRWTUI)	C-W--

Table 20: High power-consuming devices

Group object 20	
Object function	In operation
Details	<p>Cyclically receives a telegram from the smart meter and thus ensures that it is in operation.</p> <p>Is active when <<per measured value and per "In operation" object>> is set under the "Monitoring" parameter, see "Activating dynamic load management", p. 39.</p>
Possible values	0: Trigger 1: Trigger
Data width	1 bit
Data point type / data type	1.017/trigger
Direction	Write
Flags (CRWTUI)	C-W--

Table 21: In operation

10.3 Charging point 1 | 2 | 3 | 4 | 5

Group object 50 100 150 200 250	
Object function	Charging point state – state
Details	Displays the current charging point state. The current state is emitted by means of a specific value, see the following table. This value is displayed on the device website at the corresponding charging point.
Possible values	0 – 255
Data width	1 byte
Data point type/data type	Non DPT
Direction	Read
Flags (CRWTUI)	CR-T--

Table 22: Charging point state – state

Value	Charging point state	Description
0	Illegal	The charging point signals an unknown state. Contact Support if this state is constantly present.
1	Start-up	The charging point starts up.
2	Error	The charging point signals an error that can be shown via the group objects <<Charging point fault info 1-4>>.
3	Not available	The charging point signals that it is not available.
4	Cancelled	The charging process was cancelled via the group object <<Start/stop charging process>>.
5	Available	The charging point can be used.
6	Connected	A vehicle is connected with the charging point.
7	Manual start required	The charging process does not start automatically and must be started via the group object <<Start/stop charging process>>.
8	Charge	The charging process will be executed.
9	Charge with reduced current	The charging process will be executed with reduced current.
10	Charge + ventilation	The charging process will be executed and ventilation is active.

Value	Charging point state	Description
11	Interruption	<p>Depending on the current state, the charging process was interrupted or charging point availability was blocked. This charging point state is emitted</p> <ul style="list-style-type: none"> when an interruption is activated via KNX through the <<Interruption>> group object, see table 28, "Interruption," p. 54. when active grid-supporting control is enabled via KNX using the group object <<Grid-supporting control>> with setting 0 A, see table 13, "Grid-supporting control," p. 44. when an interruption is triggered through an internal charging point function, e.g. overheating. <p>If the interruption is disabled or terminated, the previous state is restored and displayed via the corresponding charging point state, e.g. <<Charge>> or <<Available>>.</p>

Table 23: Charging point state – values

Group object 51 101 151 201 251	
Object function	Connected – state
Details	Indicates whether an electric vehicle is connected.
Possible values	0: False (not connected) 1: True (connected)
Data width	1 bit
Data point type / data type	1.002/Boolean
Direction	Read
Flags (CRWTUI)	CR-T--

Table 24: Connected – state

Group object 52 102 152 202 252	
Object function	Charging – state
Details	Indicates whether an electric vehicle is being charged.
Possible values	0: Inactive (not charging) 1: Active (charging)
Data width	1 bit
Data point type / data type	1.011/state
Direction	Read
Flags (CRWTUI)	CR-T--

Table 25: Charging – state

Group object 53 103 153 203 253	
Object function	Charging complete – state
Details	Indicates whether a charging process is considered complete. The charging process is considered to be complete when the measured amperage exceeds the pre-set current threshold value for longer than the defined time. If the threshold value is exceeded, this group object is immediately reset. Depends on the setting of the <<Threshold value for "Charging complete">> and <<Time until "Charging complete">> parameters, see ETS context help ("Calling up the context help in the ETS", p. 38).
Possible values	0: False (not complete) 1: True (complete)
Data width	1 bit
Data point type / data type	1.002/Boolean
Direction	Read
Flags (CRWTUI)	CR-T--

Table 26: Charging complete – state

Group object 54 104 154 204 254	
Object function	Start/stop charging process
Details	<ul style="list-style-type: none"> Starts the charging process when the charging point is not configured for an automatic start function. The charging point signals the corresponding charging point state <<Manual start required>> (value 7). Cancels the charging process. The charging point signals the corresponding charging point state <<Cancelled>> (value 4). The charging process can only be restarted again once the electric vehicle is reconnected.
Possible values	0: Stop (terminate) 1: Start
Data width	1 bit
Data point type / data type	1.010/start/stop
Direction	Write
Flags (CRWTUI)	C-W--
This group object depends on the model.	

Table 27: Start/stop charging process

Group object 55 105 155 205 255	
Object function	Interruption
Details	<p>Interrupts the current charging point state. The interruption remains active until it is disabled again. Depending on the charging point state, the interruption can be used as follows:</p> <ul style="list-style-type: none"> • If the charging point is currently in use, the charging process is paused for the duration of the interruption. • If the charging point is currently available or a charging process has finished, the charging point is blocked for the duration of the interruption. <p>If the interruption is disabled, the previous state is restored. However, if a charging process is to be continued, it is important to note the following:</p> <ul style="list-style-type: none"> • If the charging process was previously controlled via DLM, the DLM will continue the charging process with the minimum charging current and will control the available charging current again. • If the charging process was previously controlled without DLM, the charging process is continued with the previous setpoint current. If the setpoint current is changed during the interruption, the charging process is continued with the re-defined setpoint current.
Possible values	0: False (cancel) 1: True (set)
Data width	1 bit
Data point type / data type	1.002/Boolean
Direction	Write
Flags (CRWTUI)	C-WTU-

Table 28: Interruption

Group object 56 106 156 206 256	
Object function	Interruption – state
Details	Shows whether an interruption is active.
Possible values	0: inactive 1: Active
Data width	1 bit
Data point type / data type	1.011/state
Direction	Read
Flags (CRWTUI)	CR-T--

Table 29: Interruption – state

Group object 59 109 159 209 259	
Object function	Unlock
Details	Unlocks the charging cable providing that the charging process has finished.
Possible values	0: Trigger 1: Trigger
Data width	1 bit
Data point type / data type	1.017/trigger
Direction	Write
Flags (CRWTUI)	C-W--
This group object depends on the model.	

Table 30: Unlock

Group object 60 110 160 210 260	
Object function	Setpoint charging current
Details	<p>Appears if the DLM is disabled and not in use. Sets the target charging current the electric vehicle may use as a maximum. If the set charging current falls below or exceeds the established <<Minimum charging current>> and <<Maximum charging current>> parameter values, the charging current will automatically assume the value of the minimum or maximum charging current.</p> <p>Note: Some charging points allow 0 A to be set as the setpoint charging current.</p>
Possible values	Electr. current (A)
Data width	4 byte
Data point type/data type	14.019/electr. current (A)
Direction	Write
Flags (CRWTUI)	C-W--

Table 31: Setpoint charging current

Group object 61 111 161 211 261	
Object function	Setpoint charging current – state
Details	<p>Shows the target charging current reported by the charging point.</p> <p>Note: Some charging points do not report a setpoint charging current if no electric vehicle is connected.</p>
Possible values	Electr. current (A)
Data width	4 byte
Data point type/data type	14.019/electr. current (A)
Direction	Read
Flags (CRWTUI)	CR-T--

Table 32: Setpoint charging current – state

Group object 62 112 162 212 262	
Object function	Actual charging current (sum) – state
Details	Shows the charging current used by the electric vehicle. With a 3-phase connection, the values of the three phases are added together. Note: The value is not suitable for billing.
Possible values	Electr. current (mA)/(A)
Data width	4 byte
Data point type/data type	7.012/electr. current (mA) 9.021/electr. current (mA, floating point) 14.019/electr. current (A, floating point)
Direction	Read
Flags (CRWTUI)	CR-T--
This group object depends on the model.	

Table 33: Actual charging current (sum) – state

Group object 63 113 163 213 263	
Object function	Actual charging current L1 – state
Details	Shows the phase L1 charging current used by the electric vehicle with a 3-phase connection. Note: The value is not suitable for billing.
Possible values	Electr. current (mA)/(A)
Data width	4 byte
Data point type/data type	7.012/electr. current (mA) 9.021/electr. current (mA, floating point) 14.019/electr. current (A, floating point)
Direction	Read
Flags (CRWTUI)	CR-T--
This group object depends on the model.	

Table 34: Actual charging current L1 – state

Group object 64 114 164 214 264	
Object function	Actual charging current L2 – state
Details	Shows the phase L2 charging current used by the electric vehicle with a 3-phase connection. Note: The value is not suitable for billing.
Possible values	Electr. current (mA)/(A)
Data width	4 byte
Data point type/data type	7.012/electr. current (mA) 9.021/electr. current (mA, floating point) 14.019/electr. current (A, floating point)
Direction	Read
Flags (CRWTUI)	CR-T--
This group object depends on the model.	

Table 35: Actual charging current L2 – state

Group object 65 115 165 215 265	
Object function	Actual charging current L3 – state
Details	Shows the phase L3 charging current used by the electric vehicle with a 3-phase connection. Note: The value is not suitable for billing.
Possible values	Electr. current (mA)/(A)
Data width	4 byte
Data point type/data type	7.012/electr. current (mA) 9.021/electr. current (mA, floating point) 14.019/electr. current (A, floating point)
Direction	Read
Flags (CRWTUI)	CR-T--
This group object depends on the model.	

Table 36: Actual charging current L3 – state

Group object 66 116 166 216 266	
Object function	Actual power (sum) – state
Details	Shows the currently applied power at the charging point. With a 3-phase connection, the values of the three phases are added together. Note: The value is not suitable for billing.
Possible values	Power (W)/(kW)
Data width	4 byte
Data point type/data type	9.024/power (kW, floating point) 14.056/power (W, floating point)
Direction	Read
Flags (CRWTUI)	CR-T--
This group object depends on the model.	

Table 37: Actual power (sum) – state

Group object 67 117 167 217 267	
Object function	Actual power L1 – state
Details	Shows the phase L1 power currently applied at the charging point with a 3-phase connection. Note: The value is not suitable for billing.
Possible values	Power (W)/(kW)
Data width	4 byte
Data point type/data type	9.024/power (kW, floating point) 14.056/power (W, floating point)
Direction	Read
Flags (CRWTUI)	CR-T--
This group object depends on the model.	

Table 38: Actual power L1 – state

Group object 68 118 168 218 268	
Object function	Actual power L2 – state
Details	Shows the phase L2 power currently applied at the charging point with a 3-phase connection. Note: The value is not suitable for billing.
Possible values	Power (W)/(kW)
Data width	4 byte
Data point type/data type	9.024/power (kW, floating point) 14.056/power (W, floating point)
Direction	Read
Flags (CRWTUI)	CR-T--
This group object depends on the model.	

Table 39: Actual power L2 – state

Group object 69 119 169 219 269	
Object function	Actual power L3 – state
Details	Shows the phase L3 power currently applied at the charging point with a 3-phase connection. Note: The value is not suitable for billing.
Possible values	Power (W)/(kW)
Data width	4 byte
Data point type/data type	9.024/power (kW, floating point) 14.056/power (W, floating point)
Direction	Read
Flags (CRWTUI)	CR-T--
This group object depends on the model.	

Table 40: Actual power L3 – state

Group object 70 120 170 220 270	
Object function	Actual energy (sum) – state
Details	Shows the energy consumed at the charging point. With a 3-phase connection, the values of the three phases are added together. Note: The value is not suitable for billing.
Possible values	Active energy (Wh)/(kWh)
Data width	4 byte
Data point type/data type	13.010/active energy (Wh) 13.013/active energy (kWh)
Direction	Read
Flags (CRWTUI)	CR-T--
This group object depends on the model.	

Table 41: Actual energy (sum) – state

Group object 71 121 171 221 271	
Object function	Actual energy L1 – state
Details	Shows the phase L1 energy consumed at the charging point with a 3-phase connection. Note: The value is not suitable for billing.
Possible values	Active energy (Wh)/(kWh)
Data width	4 byte
Data point type/data type	13.010/active energy (Wh) 13.013/active energy (kWh)
Direction	Read
Flags (CRWTUI)	CR-T--
This group object depends on the model.	

Table 42: Actual energy L1 – state

Group object 72 122 172 222 272	
Object function	Actual energy L2 – state
Details	Shows the phase L2 energy consumed at the charging point with a 3-phase connection. Note: The value is not suitable for billing.
Possible values	Active energy (Wh)/(kWh)
Data width	4 byte
Data point type/data type	13.010/active energy (Wh) 13.013/active energy (kWh)
Direction	Read
Flags (CRWTUI)	CR-T--
This group object depends on the model.	

Table 43: Actual energy L2 – state

Group object 73 123 173 223 273	
Object function	Actual energy L3 – state
Details	Shows the phase L3 energy consumed at the charging point with a 3-phase connection. Note: The value is not suitable for billing.
Possible values	Active energy (Wh)/(kWh)
Data width	4 byte
Data point type/data type	13.010/active energy (Wh) 13.013/active energy (kWh)
Direction	Read
Flags (CRWTUI)	CR-T--
This group object depends on the model.	

Table 44: Actual energy L3 – state

Group object 74 124 174 224 274	
Object function	Energy consumption last charge – state
Details	Shows the energy consumption of the current or last charge. Note: The value is not suitable for billing.
Possible values	Active energy (Wh)/(kWh)
Data width	4 byte
Data point type/data type	13.010/active energy (Wh) 13.013/active energy (kWh)
Direction	Read
Flags (CRWTUI)	CR-T--
This group object depends on the model.	

Table 45: Energy consumption last charge – state

Group object 75 125 175 225 275	
Object function	Energy consumption total – state
Details	Shows the total energy consumed at the charging point. Note: The value is not suitable for billing.
Possible values	Active energy (Wh)/(kWh)
Data width	4 byte
Data point type/data type	13.010/active energy (Wh) 13.013/active energy (kWh)
Direction	Read
Flags (CRWTUI)	CR-T--
This group object depends on the model.	

Table 46: Energy consumption total – state

Group object 76 126 176 226 276	
Object function	Charging process start time – state
Details	Transmits the start of the charging process.
Possible values	Time of day
Data width	3 byte
Data point type/data type	10.001/time of day
Direction	Read
Flags (CRWTUI)	CR-T--
This group object depends on the model.	

Table 47: Charging process start time – state

Group object 77 127 177 227 277	
Object function	Charging process end time – state
Details	Transmits the end of the charging process.
Possible values	Time of day
Data width	3 byte
Data point type/data type	10.001/time of day
Direction	Read
Flags (CRWTUI)	CR-T--
This group object depends on the model.	

Table 48: Charging process end time – state

Group object 78 | 128 | 178 | 228 | 278

Object function	Charging process duration – state
Details	Transmits the duration of the charging process in seconds.
Possible values	Time lag (s)
Data width	4 byte
Data point type/data type	13.100/time lag (s)
Direction	Read
Flags (CRWTUI)	CR-T--
This group object depends on the model.	

Table 49: Charging process duration – state

Group object 79 | 129 | 179 | 229 | 279

Object function	Communication ID (EVCCID)
Details	Transmits the EVCCID of the charging control device in the electric vehicle, which is required for communication between the electric vehicle and the charging point in accordance with ISO 15118.
Possible values	Character (ISO 8859-1)
Data width	14 byte
Data point type/data type	16.001/character (ISO 8859-1)
Direction	Read
Flags (CRWTUI)	CR-T--
This group object depends on the model.	

Table 50: Communication ID (EVCCID)

Group object 80 130 180 230 280	
Object function	Serial number
Details	Transmits the serial number of the charging point.
Possible values	Character (ISO 8859-1)
Data width	14 byte
Data point type/data type	16.001/character (ISO 8859-1)
Direction	Read
Flags (CRWTUI)	CR-T--
This group object depends on the model.	

Table 51: Serial number

Group object 81 131 181 231 281	
Object function	Firmware version
Details	Transmits the firmware version of the charging point.
Possible values	Character (ISO 8859-1)
Data width	14 byte
Data point type/data type	16.001/character (ISO 8859-1)
Direction	Read
Flags (CRWTUI)	CR-T--
This group object depends on the model.	

Table 52: Firmware version

Group object 82 132 182 232 282	
Object function	Internal temperature – state
Details	Transmits the internal temperature of the charging point. The transmission depends on the setting of the <<Send temperature values>> parameter, see ETS context help (“Calling up the context help in the ETS”, p. 38).
Possible values	Temperature (°C)
Data width	2 bytes
Data point type/data type	9.001/temperature (°C)
Direction	Read
Flags (CRWTUI)	CR-T--
This group object depends on the model.	

Table 53: Internal temperature – state

Group object 83 133 183 233 283	
Object function	Temperature warning
Details	Generates a warning when the charging point internal temperature increases. For this function, some charging points also require the setting of the <<Value for temperature warning>> parameter.
Possible values	0: False (warning not present) 1: True (warning present)
Data width	1 bit
Data point type / data type	1.002/Boolean
Direction	Read
Flags (CRWTUI)	CR-T--
This group object depends on the model.	

Table 54: Temperature warning

Group object 84 134 184 234 284	
Object function	RFID tag
Details	Transmits the first 4 bytes of the RFID card serial number when enabled for charging.
Possible values	Character (ISO 8859-1)
Data width	14 byte
Data point type/data type	16.001/character (ISO 8859-1)
Direction	Read
Flags (CRWTUI)	CR-T--
This group object depends on the model.	

Table 55: RFID tag

Group object 94 144 194 244 294	
Object function	Charging point fault
Details	Indicates whether a fault is present at the charging point.
Possible values	0: False (no fault present) 1: True (fault present)
Data width	1 bit
Data point type / data type	1.002/Boolean
Direction	Read
Flags (CRWTUI)	CR-T--

Table 56: Charging point fault

Group object 95 145 195 245 295	
Object function	Last charging point fault
Details	Shows information about the last or current fault.
Possible values	For details of the corresponding error code, see “Faults affecting the charging point”, p. 75.
Data width	14 byte
Data point type/data type	16.001/character (ISO 8859-1)
Direction	Read
Flags (CRWTUI)	CR-T--

Table 57: Last charging point fault

Group object 96 146 196 246 296	
Object function	Charging point fault info 1
Details	Shows the manufacturer’s error code as a readable hexadecimal value. If the error code has several parts, this group object will show the first part. The complete error code shows the internal state of the charging point. Note: Please note the error code descriptions in the manufacturer’s specifications.
Possible values	Character (ASCII) Character (ISO 8859-1)
Data width	14 byte
Data point type/data type	16.001/character (ISO 8859-1)
Direction	Read
Flags (CRWTUI)	CR-T--
This group object depends on the model.	

Table 58: Charging point fault info 1

Group object 97 147 197 247 297	
Object function	Charging point fault info 2
Details	Shows the second part of the manufacturer's error code as a readable hexadecimal value if the error code consists of several parts. The complete error code shows the internal state of the charging point. Note: Please note the error code descriptions in the manufacturer's specifications.
Possible values	Character (ASCII) Character (ISO 8859-1)
Data width	14 byte
Data point type/data type	16.001/character (ISO 8859-1)
Direction	Read
Flags (CRWTUI)	CR-T--
This group object depends on the model.	

Table 59: Charging point fault info 2

Group object 98 148 198 248 298	
Object function	Charging point fault info 3
Details	Shows the third part of the manufacturer's error code as a readable hexadecimal value if the error code consists of several parts. The complete error code shows the internal state of the charging point. Note: Please note the error code descriptions in the manufacturer's specifications.
Possible values	Character (ASCII) Character (ISO 8859-1)
Data width	14 byte
Data point type/data type	16.001/character (ISO 8859-1)
Direction	Read
Flags (CRWTUI)	CR-T--
This group object depends on the model.	

Table 60: Charging point fault info 3

Group object 99 149 199 249 299	
Object function	Charging point fault info 4
Details	Shows the fourth part of the manufacturer's error code as a readable hexadecimal value if the error code consists of several parts. The complete error code shows the internal state of the charging point. Note: Please note the error code descriptions in the manufacturer's specifications.
Possible values	Character (ASCII) Character (ISO 8859-1)
Data width	14 byte
Data point type/data type	16.001/character (ISO 8859-1)
Direction	Read
Flags (CRWTUI)	CR-T--
This group object depends on the model.	

Table 61: Charging point fault info 4

11 Troubleshooting

The device LEDs give you information on operating state errors as well as faults after configuration:

- ▶ See LEDs during device start-up, p. 26.
- ▶ See LEDs in operation, p. 27.
- ▶ See “APP” LED for faults, p. 28.

11.1 Faults after configuration

In the event of a fault, the error codes are shown on the device website under <<Status>>.

- Faults that affect the device are shown in the <<General>> area.
- Faults that affect a charging point are shown in the corresponding <<Charging point 1 | 2 | 3 | 4 | 5>> area.

The fault display shows the last or current fault. Each new error overwrites the information of the last error. If the fault display has the value <<No fault>>, no faults have occurred since commissioning.

Fault severity

- Faults with a severity level of 120 to 130 are serious faults that will prevent the use of the charging point. The “App” LED will signal the fault by flashing five times. To remedy the fault, a new configuration in the ETS is required.
- Faults with a severity level of 60 to 110 are temporary faults that only affect the function of the corresponding component or charging point. The “App” LED will signal the fault by flashing three times.
- Faults with severity level 10 or 50 are automatically reset when next called and do not emit any visual signals via the “App” LED.

-  Faults with a lower severity level cannot overwrite faults with a higher severity level. This means that if the <<SmartMeterTOut>> fault (level 90) occurs when the <<Conf Charger>> fault (level 120) is already present, the fault state will remain unchanged.
The same applies for the LED flashing code: If several faults with different severity levels are present, the LED flashing code will always appear for the current fault with the highest severity level.

General faults

The current fault is shown by group object 9 <<Last fault>> and the device website, ► See Accessing the device website, p. 22.

Error code	Severity level	Description	Possible cause / correction
ContactSupport	130	A serious error is present.	Generate the log files and contact Support.
Conf NoCharger	120	No charging point has been configured because the configuration of all charging points is not complete.	Make sure that the details regarding manufacturer, model or IP address or Modbus client address are complete.
Conf Charger	120	At least one charging point has not been configured properly. The charging point whose configuration triggers the fault is marked as faulty, but is not necessarily the cause. The cause may be a previously configured charging point.	<p>Check the following charging point settings:</p> <ul style="list-style-type: none"> • Modbus TCP: an IP address is being used several times. • Modbus RTU/ASCII: an invalid combination of RTU and ASCII protocols is present. • Prioritised charging point is disabled, i.e. IP address is 0.0.0.0. Or Modbus client address is 0. • Details of manufacturer and model are missing for the prioritised charging point.
Conf EMeter	120	At least one charging point electricity meter has not been configured properly. The electricity meter whose configuration triggers the fault is marked as faulty, but is not necessarily the cause. The cause may be in a previously configured electricity meter.	<p>Check the following electricity meter settings at the charging point:</p> <ul style="list-style-type: none"> • Modbus TCP: an IP address is being used several times. • Modbus RTU/ASCII: a Modbus client address is being used several times.
DLMAssociation	120	Not all group objects required for the DLM are linked.	Check whether all group objects required for the DLM are linked with the group addresses.
SmartMeterTOut	90	The smart meter has not transmitted the values within the specified interval. The DLM goes into emergency mode. This means that the DLM regulates distribution down to the minimum charging current per charging point.	<p>If there is constant alternation between brief fault display and transmission, check that the transmission interval defined in the ETS is the same as that of the smart meter.</p> <p>If the fault is permanent, the group address may be incorrectly configured or the smart meter may be defective.</p>
OverCurrent	80	An overcurrent is present. The DLM interrupts the charging processes at all charging points.	The sum of the minimum charging currents for the active charging points causes an overcurrent. Check the installation and configuration.

Error code	Severity level	Description	Possible cause / correction
DLM InvCurrent	70	At least one charging point is supplying invalid current values. The DLM cannot take the affected charging points into account. Charging is not possible at the charging point.	The meter inside a charging point is defective or unavailable. Refer to the manufacturer documentation for help or contact the charging point manufacturer.
No error	-	The device is functioning normally (normal operation), no fault since device start-up.	-

Table 62: Error codes general

Faults affecting the charging point

The current fault is shown by group object 95 | 145 | 195 | 245 | 295 <<Last charging point fault>> as well as the device website, ► See Accessing the device website, p. 22.

Error code	Severity level	Description	Possible cause / correction
Conf Charger	120	The configuration of a current or previously configured charging point is incorrect.	<p>Check the settings for the current charging point as well as the previously configured charging points:</p> <ul style="list-style-type: none"> • Modbus TCP: an IP address is being used several times. • Modbus RTU/ASCII: an invalid combination of RTU and ASCII protocols is present. • Prioritised charging point is disabled, i.e. IP address is 0.0.0.0 or Modbus client address is 0. • Details of manufacturer and model are missing for the prioritised charging point.
Conf EMeter	120	The configuration of a current or previously configured charging point electricity meter is incorrect.	<p>Check the settings for the current electricity meter as well as the previously configured electricity meter:</p> <ul style="list-style-type: none"> • Modbus TCP: an IP address is being used several times. • Modbus RTU/ASCII: a Modbus client address is being used several times.
DLM InvCurrent	90	The charging point is supplying an invalid current value. The DLM cannot take the affected charging point into account. Charging is not possible at the charging point.	The meter inside a charging point is defective or unavailable. Refer to the manufacturer documentation for help or contact the charging point manufacturer.
NotReachable	80	The charging point cannot be reached.	<p>Modbus TCP: Make sure that the IP address is correct and check the network connection between the gateway and charging point with regard to e.g. cable connection and firewall.</p> <p>Modbus RTU/ASCII: Make sure that the Modbus client address is correct and check the Modbus cabling.</p>
WrongCharger	70	The configured charging point does not coincide with the connected charging point.	Check the manufacturer and model details.
Comm	60	Communication to the charging point failed despite an existing connection. This means that the charging point gives erroneous answers to a query.	<p>Check that the charging point firmware is compatible. A firmware update may have caused incompatibility.</p> <p>If the fault continues, generate the log files and contact Support.</p>

Error code	Severity level	Description	Possible cause / correction
ChargerError	50	The charging point signals a fault regarding the internal state described by the group objects <<Charging point fault info 1 2 3 4>> (96 97 98 99 + offset). The error code displayed is provided by the manufacturer and is only passed on by the group objects.	Refer to the manufacturer documentation for help or contact the charging point manufacturer.
OpNotPossible	40	The current status at the charging point is preventing the action: A manual start or stop cannot be activated using the <<Start/stop charging process>> function. The fault is for information only and is immediately automatically reset.	<p>The charging point is configured for an automatic start function. Check the configuration.</p> <p>The charging process has already been started using the <<Start/stop charging process>> function. However, a manual start has been activated using this function again. If the action has already been started, it cannot be activated again. No remedial action required.</p>
ValOutOfRange	40	The set value is outside of the permitted range. The fault is for information only and is immediately automatically reset.	Check your set value – it is outside of the permitted range.
EMeterNotReach	30	The electricity meter at the charging point cannot be reached.	<p>Modbus TCP: Make sure that the IP address is correct and check the network connection between the gateway and smart meter with regard to the cable connection and firewall.</p> <p>Modbus RTU/ASCII: Make sure that the Modbus client address is correct and check the Modbus cabling.</p> <p>Make sure that the electricity meter is using the connection parameters stored in the ETS.</p>
EMeter Comm	20	Communication to the electricity meter at the charging point failed despite an existing connection. This means that the electricity meter gives erroneous answers to a query.	<p>Check the ETS settings on the electricity meter.</p> <p>If the fault continues, generate the log files and contact Support.</p>
EMeter Error	10	The electricity meter at the charging point shows a fault in the internal state.	<p>Refer to the manufacturer documentation for help or contact the electricity meter manufacturer.</p> <p>Check the ETS settings.</p>

Error code	Severity level	Description	Possible cause / correction
No error	-	The charging point and any installed electricity meter are in working order (normal operation), no fault since device start-up.	-

Table 63: Charging point error codes

11.2 Generating log files

Support uses log files to obtain information to help analyse your problem. You generate these log files via the device website and download them as a ZIP file.

You configure the scope of the information contained in the log files using the logging mode. Our Support may ask you to configure the logging mode.

1. Open the device website at ► See Accessing the device website, p. 22.
2. On the <<Settings>> page in the <<General>> area, select the corresponding button under <<Logging mode>>.

<<Simple>>	Basic information is collected.
<<Extended>>	Detailed information is collected.



<<Extended>> logging mode has a negative influence on performance. Only activate this mode if Support requests the extended log files. Deactivate this mode again as soon as you have generated the log files.

3. Click on the <<Download log file>> button. The log files are compiled and downloaded as a ZIP file.

11.3 Contacting Support

If you have a problem with your SMART CONNECT KNX e-charge II and require support, contact us:

- E-mail to support@ise.de
- Call us on tel.: +49 441 680 06 12
- Fax us: +49 441 680 06 15

We will need the following data in order to help you:



- To identify the device: Product name or order number
- MAC address (optional)
- Version of the firmware
- ETS version
- A meaningful error description including the error code (if there is one)

Also helpful:

- Log files
- Screenshot of <<Status>> on the device website

11.4 FAQs - Frequently asked questions

How do I find the IP address of my SMART CONNECT KNX e-charge II?

Detailed information on IP address ► See IP settings, p. 31.

Why is my SMART CONNECT KNX e-charge II not generating a response at the charging point?

There can be several reasons for this. Start by checking the operating state of the device,
► See Reading device status using the LEDs, p. 24.

A fault may have occurred after configuration. The device website gives you an error code and the “App” LED emits an optical warning signal.

- ► See Accessing the device website, p. 22.
- ► See “APP” LED for faults, p. 28.
- ► See Faults after configuration, p. 72.

Does a microSD card have to be inserted in the SMART CONNECT KNX e-charge II?

No, the microSD card slot is not in use.

Why does the ETS report an error during application program download?

- You might be using an older ETS version. The application accesses ETS functions that are not supported by older ETS versions. Make sure that your ETS version is up to date. The SMART CONNECT KNX e-charge II is configured via the ETS from v5.7.5. Older versions of the ETS cannot be used for configuration.
- The product database entry you are using in the ETS might be incompatible with the device firmware. Check the compatibility between the product database entry and firmware version ► See Compatibility between product database entry and firmware version, p. 36.

Why is the “Conf NoCharger” error displayed during installation?

Check the ETS version. You need an ETS version from v5.7.5.
Alternative error sources and their remedies ► See General faults, p. 73.

Can I integrate charging points both with IP connection and RS485 connection (Modbus) via a SMART CONNECT KNX e-charge II?

Yes, you can simultaneously integrate charging points with both connection types via the SMART CONNECT KNX e-charge II ► See Mixed operation, p. 7.

Can I install different charging point models with an RS485 connection (Modbus)?

No, you can only integrate one model type with an RS485 connection (Modbus) via the SMART CONNECT KNX e-charge II. You can install up to five charging points of this model type ► See Mixed operation, p. 7.

Why is my electric vehicle taking an usually long time to charge?

The reasons for this may be to do with the configuration. Check whether

- another charging point is prioritised and an electric vehicle is currently being charged there. If so, it is likely that only the minimum charging current is available for your electric vehicle.
- the minimum and maximum charging currents have been configured for the electric vehicle.
- the dynamic load management values, e.g. overcurrent protection device and load reserve are configured in accordance with on-site conditions.
- grid-supporting control is active.

Why does the charging point not show the group object I am looking for?

Function support depends on the model, see [product page](#). As soon as you have assigned the manufacturer and model to the charging point during configuration, the corresponding group objects will be shown. Some group objects depend on the corresponding parameter setting.

► See Group objects, p. 44.

Where is the context help?

From version 5.6, the ETS offers a context help function, which provides detailed information about parameters and appears directly in the parameter dialogue. To enable the context help, open the parameter dialogue and click on the <<Context help>> button on the toolbar. To show the context help of a parameter, click on the desired parameter (“Calling up the context help in the ETS”, p. 38).

Can I control more than five charging points?

You can connect up to five charging points with the firmware version v1.3 of SMART CONNECT KNX e-charge II. It is not possible to cascade several SMART CONNECT KNX e-charge II in one system. For complex challenges, we recommend consulting the “Individual solution” section on our [product page](#).

12 Disassembly and Disposal

If you want to disassemble the device, due to a defect, for example, proceed in reverse order to installation.

Removing the cover cap



Warning

Danger from incorrect use

Incorrect use can result in damage to the device, fire or other dangers.

- Only qualified electricians may install and disassemble electrical devices.
- Follow the instructions in this product manual.



Warning

Danger of electric shock

An electric shock can result from touching live parts in the installation environment. Electric shock can cause death.

- Enable the device.
- Cover up live parts in the vicinity.

1. Gently press in the cover cap at the side (see figure 27, item 1).
2. Pull off the cover cap upwards (see figure 27, item 2).

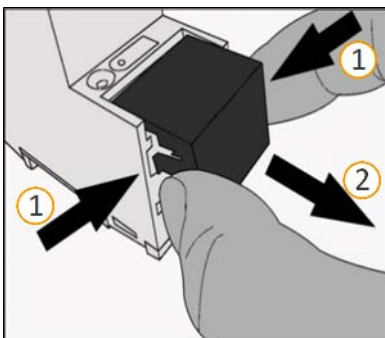

Figure 27: Removing the cover cap

Detaching the device from the top-hat rail

Requirement: Power supply, bus line and network connection are disconnected.

1. Insert a screwdriver (see figure 28, item 1) into the release lever (see figure 28, item 2) and push the release lever down (see figure 28, item 3).
2. Take the device off the top-hat rail.

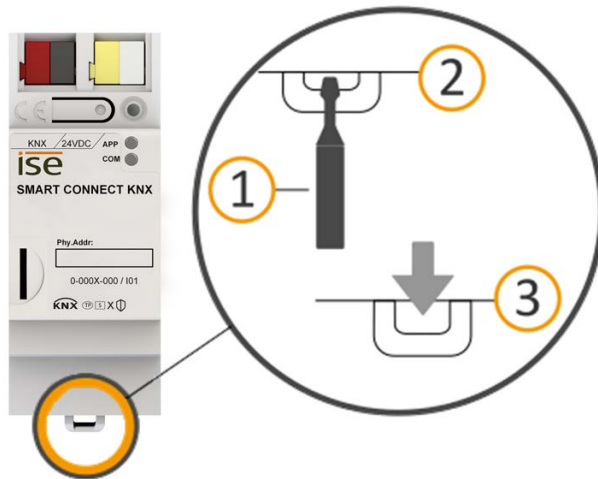

Figure 28: Detaching the device from the top-hat rail

Disposal

Make an active contribution to protecting the environment by disposing of all materials in an environmentally-responsible way.

Packaging and box



Dispose of the packaging material appropriately, in a card, paper or plastic recycling bins.

Device



Old devices must not be disposed of with domestic refuse!

You can dispose of your old device free of charge at designated collection facilities or, if necessary, you can hand it in to your specialist dealer. Contact your local authority for recycling details.

13 Glossary

DP type, data point type

The data point type is the standard coding for data transmitted via group telegrams.

Electric vehicle

Electric vehicle is generally used to refer to a vehicle powered by an electric motor, such as a car, bus, motorbike, bicycle, etc. In this documentation, electric vehicle only refers to a car.

ETS (Engineering Tool Software)

The device is configured in the ETS software. The ETS is available with various ranges of functions from the KNX Association (www.knx.org).

FDSK (Factory Default Setup Key)

The FDSK is used for secure communication between category "KNX IP Secure Device" devices. The combination of FDSK and serial number enables each device to be unambiguously identified. Together, they form the device certificate.

Depending on the use case, the FDSK is required for initial authentication in the ETS or for the encryption of communication.

The FDSK is printed on a sticker on the side of the device. A second sticker is enclosed with the product.

Firmware update tool

Software which is embedded on the device hardware and enables operation of the device. Function enhancements for the device are available via a new firmware version.

Flags (CRWTUI)

Every group object has flags with which the group object obtains methods: C=Communication, R=Read, W=Write, T=Transfer, U=Update, I=Initialise.

Device website

Applications used to check device status, update loading and the display of device information.

Catalogue

Short for "Online KNX Product Catalogue". The catalogue is a product database. The catalogue contains all KNX-certified devices. The device data is saved as a product database entry.

Charging point

A charging point is an interface that can be used to charge one electric car at a time. The number of charging points shows how many vehicles can be charged at the same time. A charging point can be equipped with various socket types (pin jack, cable).

Charging point state

The charging point state shows the function that the charging point is currently executing, e.g. charging, pause, fault.

Charging station

A charging station is a location where electric vehicles can be charged. For instance, a charging station can be a vertically installed charging post or a wall-mounted wallbox. A charging station can provide one or more charging points and thus determine the number of electric vehicles that can be charged at the same time.

Modbus RTU/ASCII

Modbus TRU and Modbus ASCII are used in serial communication (RS485). Modbus RTU transmits data in binary form. Modbus ASCII transmits ASCII code and not binary sequences.

Modbus TCP

The Modbus TCP is very similar to RTU, except that TCP/IP packages are used to transmit data. TCP port 502 is reserved for Modbus/TCP.

Offset

The numerical assignment of functionally identical group objects that are used more than once in a project is carried out with the help of a defined offset. The offset is a constant value which, when added or subtracted, represents the offset between the group objects.

Offset 50 example:

Group object 100 (component 1) + offset 50 = group object 150 (component 2)

Group object 150 (component 2) + offset 50 = group object 200 (component 3)

Product database entry (also catalogue entry)

Data relating to a device in the "Online KNX Product Catalogue" of the ETS. The product database entry contains all data to allow the device to be configured in the ETS. The product database entry is provided in the form of a file by the device manufacturer. The latest version of product database entries from ise Individuelle Software und Elektronik GmbH can be downloaded free of charge from our website www.ise.de.

The product database entry is often also called the "catalogue entry".

Smart meter

A smart meter is an intelligent measuring system that consists of a digital electricity meter and a communication unit (smart meter gateway). The smart meter can process and automatically transmit measured values.

High power-consuming devices

A high power-consuming device is one of the highest power consumers in the building.

Electricity meter (at the charging point)

The electricity meter is used for measuring consumption values (current, power and energy) at charging points that are not fitted with an integrated meter by the manufacturer.

Updates

You will find information on new versions of the firmware in this documentation under the search term "Update".

Website

Information on the device's application can be found in this documentation under the search term "Device website".

14 Licence Agreement SMART CONNECT KNX e-charge II

The following outlines the contract terms for your use of the software as the "licensee".

On accepting this agreement and installing the SMART CONNECT KNX e-charge II software or putting the SMART CONNECT KNX e-charge II into use, you conclude an agreement with ise Individuelle Software und Elektronik GmbH and agree to abide by the terms in this agreement.

14.1 Definitions

Licensor: ise Individuelle Software und Elektronik GmbH, Oldenburg (Oldb), Osterstraße 15, Germany

Licensee: The legal recipient of the SMART CONNECT KNX e-charge II software.

Firmware: Software which is embedded into the SMART CONNECT KNX e-charge II hardware and is used to operate the SMART CONNECT KNX e-charge II.

SMART CONNECT KNX e-charge II: The SMART CONNECT KNX e-charge II software designates all of the software provided for the SMART CONNECT KNX e-charge II product, including the operating data. This includes, in particular, the firmware and the product database.

14.2 Object of the agreement

The object of this agreement is the SMART CONNECT KNX e-charge II software provided on data storage devices or through downloads and the associated documentation in written or electronic format.

14.3 Software usage rights

The licensor grants the licensee the non-exclusive, non-transferable right to use the SMART CONNECT KNX e-charge II software for an unlimited time in accordance with the following conditions for the purposes and applications specified in the valid version of the documentation (which shall be provided in printed format or also as online help or online documentation).

The licensee is obliged to ensure that each person who uses the program only does so as part of this license agreement and observes this license agreement.

14.4 Restriction of rights of use

14.4.1 Copying, modification and transmission

The licensee is not authorised to use, copy, modify or transfer the SMART CONNECT KNX e-charge II software in whole or in part in any way other than as described herein. Excluded from this is one (1) copy produced by the licensee exclusively for archiving and backup purposes.

14.4.2 Reverse engineering and conversion technologies

The licensee is not authorised to apply reverse-engineering techniques to the SMART CONNECT KNX e-charge II software or to convert the SMART CONNECT KNX e-charge II software into another type. Such techniques include, in particular, disassembly (conversion of the binary-coded computer instructions of an executable program into an assembler language which can be read by humans) or decompilation (conversion of binary-coded computer instructions or assembler instructions into source code in the form of high-level language instructions).

14.4.3 Firmware and hardware

The firmware may only be installed and used on the hardware (SMART CONNECT KNX e-charge II) ap-

proved by the licensor.

14.4.4 Transfer to a third party

The SMART CONNECT KNX e-charge II software must not be transferred or made accessible to third parties.

14.4.5 Renting out, leasing out and sub-licensing

The licensee is not authorised to rent or lease the SMART CONNECT KNX e-charge II software or grant sub-licenses to the program.

14.4.6 Software creation

The licensee requires written approval from the licensor to create and distribute software which is derived from the SMART CONNECT KNX e-charge II software.

14.4.7 The mechanisms of license management and copy protection

The mechanisms of the license management and copy protection of the SMART CONNECT KNX e-charge II software must not be analysed, published, circumvented or disabled.

14.5 Software development

The licensor is entitled to collect and process information about the parameterisation of the SMART CONNECT KNX e-charge II, providing that this information is collected in a manner that prevents any conclusions from being drawn about the identity of the licensee. This information is exclusively intended for the targeted development of the SMART CONNECT KNX e-charge II and the related provision of software updates and product support.

14.6 Property and confidentiality

14.6.1 Documentation

The SMART CONNECT KNX e-charge II software and its documentation (which shall be provided in printed format or also as online help or online documentation) are business secrets of the licensor and/or the object of copyright and/or other rights and shall continue to belong to the licensor. The licensee shall observe these rights.

14.6.2 Transfer to a third party

Neither the software, the data backup copy nor the documentation (which shall be provided in printed format or also as online help or online documentation) may be passed on to third parties at any point in time, in whole or in part, for a fee or free of charge.

14.7 Modifications and subsequent deliveries

The SMART CONNECT KNX e-charge II software and the documentation (which shall be provided in printed format or additionally as online help or online documentation) shall be subject to possible changes by the licensor. You will find the latest software and documentation versions at www.ise.de.

14.8 Warranty

The SMART CONNECT KNX e-charge II software works together with software from third parties. No warranty is provided for software from third parties. For more information ► see Open Source Software, p. 90.

14.8.1 Software and documentation

The SMART CONNECT KNX e-charge II software and the documentation (which shall be provided in printed form or additionally as online help or online documentation) shall be provided to the licensee in the respective valid version. The warranty period for the SMART CONNECT KNX e-charge II software is 24 months. The licensor shall provide the following warranty during this time:

- The software shall be free of material and manufacturing defects when handed over to the customer.
- The software shall function as described in the documentation enclosed with it in its respective valid version.
- The software shall be executable on the computer stations specified by the licensor.

The warranty shall be fulfilled with the supply of spare parts.

14.8.2 Limitation of warranty

No warranty is given for the freedom from errors of the SMART CONNECT KNX e-charge II software and its data structures. Similarly, the warranty does not cover defects due to improper use or other causes beyond the control of the licensor. Any additional warranty claims shall be excluded.

14.9 Liability

The licensor is not liable for damages due to loss of profit, data loss or any other financial loss resulting from the use of the SMART CONNECT KNX e-charge II software, even if the licensor is aware of the possibility of such damage.

This limitation of liability is valid for all the licensee's damage claims, regardless of the legal basis. In any case, liability is limited to the purchase price of the product.

The exclusion of liability does not apply to damage caused due to wilful intent or gross negligence on the part of the licensor. Furthermore, claims based on the statutory regulations for product liability shall remain intact.

14.10 Applicable law

This agreement is subject to the laws of the Federal Republic of Germany.
The place of jurisdiction is Oldenburg (Oldb).

14.11 Termination

This agreement and the rights granted herein shall end if the licensee fails to fulfil one or more provisions of this agreement or terminates this agreement in writing. The supplied SMART CONNECT KNX e-charge II software and its documentation (which is provided in printed format or also as online help or online documentation), including all copies, shall be returned immediately in such a case without the licensor specifically requesting their return. No claim to reimbursement of the price paid shall be accepted in such a case.

The license to use the SMART CONNECT KNX e-charge II software shall expire upon termination of the agreement. In this case, the SMART CONNECT KNX e-charge II product must be taken out of operation. Further use of the SMART CONNECT KNX e-charge II without a licence is forbidden.

The commissioning and visualisation software must be uninstalled and all copies must be destroyed or returned to the licensor.

14.12 Subsidiary agreements and changes to the agreement

Subsidiary agreements and changes to the agreement shall only be valid in writing.

14.13 Exception

All rights not expressly mentioned in this agreement are reserved.

15 Open Source Software

This product uses software from third-party sources which are published within the framework of various Open Source licences.

The individual software packages used and their licences are listed and described on the device website for this product and can be accessed in the status bar.

The source code for the Open Source software used in this product can be obtained by sending an e-mail to support@ise.de.

This offer is valid for 3 years after the service for this product has been discontinued.

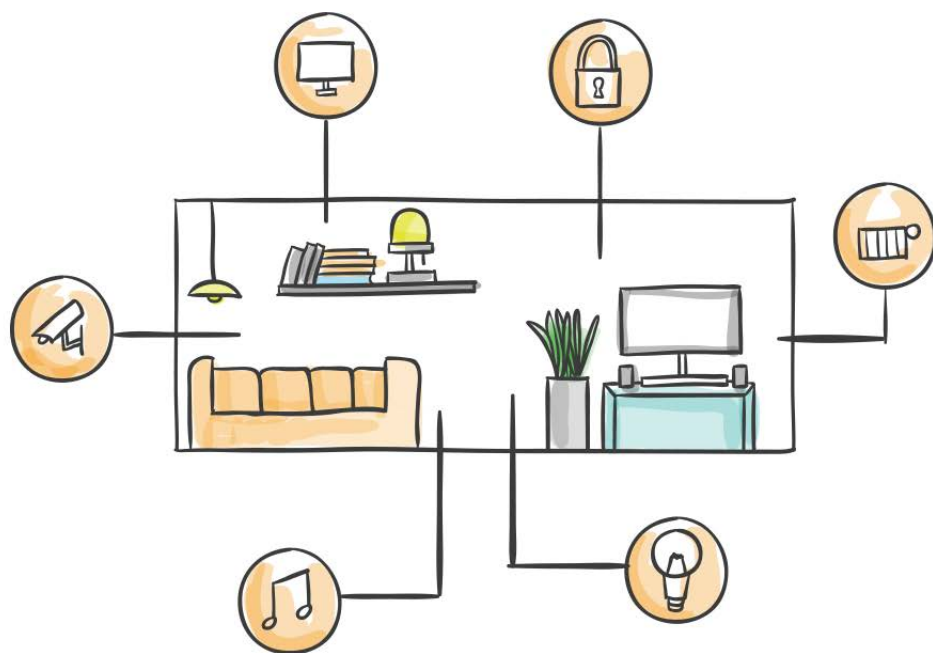

ise Individuelle Software und Elektronik GmbH
Osterstraße 15
26122 Oldenburg, Germany

Phone: +49 441 680 06 11
Fax: +49 441 680 06 15
E-mail: sales@ise.de