

SpaceLogic KNX

# DALI Gateway Pro

## Application description

This document describes the ETS software application used to program the device.

MTN6725-0101

Firmware Version 2.0  
2023/05



## Content

1	General product information.....	7
1.1	Using the application program.....	7
1.2	Impact and compatibility.....	7
1.2.1	Impact for Web Access.....	7
1.3	DALI Bus system properties.....	7
1.4	SpaceLogic KNX DALI Gateway Pro product features.....	9
1.5	Operating concept.....	11
1.6	Scope of delivery and commissioning.....	12
2	KNX Secure.....	13
2.1	Secure Usage.....	13
2.2	Unsecure Usage.....	14
2.3	Master-Reset.....	14
3	Colour control.....	15
3.1	Features of DALI device Type 8.....	15
3.2	Colour display via XY coordinates.....	15
3.3	Colour display via colour temperature.....	16
3.4	Colour display via 3 or 4 colour channels (RGBWAF).....	16
3.5	Colour display via 2 DT-6 LED types.....	16
4	Operating modes.....	17
4.1	Normal mode.....	17
4.2	Permanent mode.....	17
4.3	Staircase mode.....	17
4.4	Night mode.....	18
4.5	Panic mode (special case).....	18
4.6	Test mode for central battery emergency lights.....	18
4.7	Operating mode hierarchy.....	19
5	Light Control Module.....	20
5.1	Light Control Diagnostic.....	21
6	Analysis and service functions.....	23
6.1	Energy Reporting according to DALI Part 252.....	23
6.2	Recording operating hours.....	23
6.3	Failure recognition at ECG level.....	23
6.4	Failure analysis at group level.....	24
6.5	Failure analysis at device level.....	24
7	Webserver commissioning and operation.....	25
7.1	Commissioning and operation.....	25
7.2	Safety aspects.....	25
7.3	Import of the CA Root Certificate.....	26
7.4	User Accounts.....	27
7.4.1	Administartor.....	27
7.4.2	Normal User.....	27
7.5	Password management and login.....	28
7.5.1	Password forgotten.....	29
7.6	Log-In the website.....	30
7.7	Administration of the website.....	30
7.7.1	Generate New Device Certificate.....	31
7.7.2	Download Issuer Certificate.....	31
7.7.3	Update Firmware.....	32
7.7.4	New Admin Password.....	32
7.7.5	New User Password.....	32
7.7.6	API/MQTT Access Configuration.....	33

7.8	Language Setting on Website .....	33
7.9	Calling the start page.....	33
7.10	Actions on the website.....	34
7.11	Automatic log-off.....	34
8	System diagnostics .....	35
8.1	Requirements and Function .....	35
8.2	Viewing the Diagnostic Information .....	36
8.3	Website access of other gateways.....	36
9	Installation and commissioning concept.....	37
9.1	DALI New installation .....	38
9.2	Identification and assignment of DALI ECGs .....	38
9.3	ETS-App (DCA).....	39
9.4	Parametrisation .....	40
9.5	Synchronization between web pages and DCA .....	40
10	Maintenance and expansion .....	41
10.1	Quick exchange of individual ECGs .....	41
10.2	DALI Post-installation .....	41
11	DALI Commissioning ECG .....	43
11.1	DCA Commissioning .....	43
11.1.1	Preparation .....	43
11.1.2	New installation .....	45
11.1.3	ECG and group detail info .....	50
11.1.4	Failure and status display.....	51
11.1.4.1	ECG info in the right-hand side tree .....	52
11.1.4.2	ECG info in the ECG table.....	52
11.1.4.3	Group Info in the group tree .....	53
11.1.5	Operating DALI devices.....	53
11.1.6	Post Installation .....	55
11.1.7	ECG Quick exchange .....	56
11.1.8	Status Sync.....	57
11.1.9	Restoring the DALI configuration .....	57
11.2	Website Commissioning .....	58
11.2.1	Preparation .....	58
11.2.2	New Installation .....	59
11.2.3	Post Installation .....	61
11.2.4	Failure and status display.....	62
11.2.5	Operating DALI devices.....	62
11.2.6	Group/ECG Assignment.....	64
12	DALI Commissioning Input Devices.....	65
12.1	DCA Commissioning .....	65
12.1.1	Preparation .....	66
12.1.2	New Installation .....	67
12.1.3	Assignment of input devices to ETS Items.....	68
12.1.4	Post Installation .....	70
12.1.5	Using more than 1 Instance.....	71
12.1.6	DALI Push Buttons / Push Button Interfaces.....	72
12.1.7	Special Input Devices (Generic Inputs).....	73
12.1.8	Customized Settings.....	74
12.1.9	Failure and status display.....	74
12.1.10	Retrieving the GTIN.....	75
12.1.11	Website Commissioning .....	75
13	The scene module.....	76
13.1	Scene configuration via DCA .....	76
13.1.1	Configuration .....	76
13.1.2	Colour setting .....	79

13.1.2.1	Groups with flexible Colour Control Types .....	80
13.1.3	Programming scenes.....	80
13.1.4	Testing a scene event .....	80
13.1.5	Testing the scene as a whole .....	81
13.1.6	Export/Import/Delete.....	81
13.2	Scene configuration via web server .....	81
13.2.1	Configuration .....	81
13.2.2	Colour Settings .....	83
13.2.2.1	Groups with variable colour control .....	83
13.2.3	Programming the scenes and scene test.....	84
13.2.4	Testing an event in the scene.....	84
14	The effect module.....	85
14.1	Effect configuration with the DCA.....	85
14.1.1	Configuration .....	85
14.1.2	Colour settings.....	86
14.1.3	Programming effects .....	88
14.1.4	Testing an effect event .....	88
14.1.5	Testing the whole effect.....	88
14.1.6	Export/Import/Delete.....	89
14.2	Effect configuration via web server .....	89
14.2.1	Configuration .....	89
14.2.2	Colour settings.....	91
14.2.2.1	Groups with variable colour control .....	91
14.2.3	Programming the effects and effect test.....	92
14.2.4	Testing an event in an effect .....	92
15	Time control module for values and colours .....	93
15.1	Time schedules configuration with DCA.....	93
15.1.1	Configuration .....	93
15.1.2	Types of action .....	96
15.1.3	Disable/enable .....	99
15.1.4	Manual Override .....	99
15.1.5	Export/Import.....	100
15.2	Time schedules configuration via web server .....	100
15.2.1	Configuration .....	101
15.2.2	Types of action .....	102
15.2.3	Disable/enable.....	104
15.2.4	Manual Override.....	104
15.2.5	Assignment of groups and ECGs .....	104
15.2.6	Programming the time programs.....	104
15.2.7	Export/Import .....	104
15.3	Timer.....	105
16	Self-contained battery emergency lights .....	106
16.1	Self-contained battery emergency lights .....	106
16.2	Identification of self-contained battery emergency lights .....	107
16.3	Converter inhibit mode .....	107
16.4	Test mode for self-contained battery emergency lights .....	107
16.5	Emergency Test Results .....	108
16.5.1	DCA report.....	108
16.5.1.1	Detailed information about emergency lights .....	108
16.5.1.2	Exporting test results .....	109
16.5.2	Website Report.....	110
16.5.2.1	Detailed information of an emergency lamp.....	110
16.5.2.2	Exporting the test results in xml.....	111
16.5.2.1	Exporting the test result as HTML Print.....	112
17	DCA Extras.....	113
17.1	Menu: Edit Descriptions.....	114

18 Commissioning/operating via display and pushbuttons .....	115
18.1 Main menu level 1 .....	115
18.2 Sub-menu level 2.....	116
18.2.1 Sub-menu language .....	116
18.2.2 Sub-menu IP network / address .....	116
18.2.3 Sub-menu new installation .....	116
18.2.4 Sub-menu post-installation .....	117
18.2.5 Sub-menu ECG quick exchange .....	117
18.2.6 Sub-menu group assignment .....	118
18.2.7 Sub-menu group test.....	118
18.2.8 Sub-menu scene test.....	119
18.2.9 Sub-menu system test.....	119
18.2.10 Sub-menu maintenance ECG/lamp.....	120
18.2.11 Sub-menu converter inhibit mode .....	120
19 ETS communication objects.....	121
19.1 General objects .....	121
19.1.1 General objects behavior.....	121
19.1.2 General objects analysis and service.....	121
19.1.3 General objects special functions.....	124
19.1.3.1 Objects for Energy Saving.....	125
19.1.3.2 Objects for emergency .....	125
19.1.4 Time control objects .....	125
19.2 Broadcast objects .....	126
19.2.1 Broadcast objects colour control .....	126
19.3 Group objects .....	128
19.3.1 Group objects behaviour .....	128
19.3.2 Group objects colour control.....	129
19.3.2.1 Colour temperature.....	129
19.3.2.2 RGB .....	130
19.3.2.3 HSV .....	131
19.3.2.4 RGBW.....	132
19.3.2.5 HSVW (separate Objects) .....	134
19.3.2.6 XY Colour .....	134
19.3.2.7 Colour temperature + RGB.....	136
19.3.2.8 Colour temperature + RGBW .....	139
19.3.3 Group objects analysis and service.....	143
19.4 Single ECG objects .....	143
19.4.1 Single ECG objects behaviour .....	143
19.4.2 Single ECG objects colour control.....	144
19.4.3 Single ECG Emergency Setting .....	147
19.4.3.1 Objects according to the new KNX standard:.....	147
19.4.3.2 Objects according to earlier versions .....	150
19.4.4 Single ECG objects analysis and service.....	151
19.5 Motion detector /Brightness sensor objects .....	152
19.6 Generic DALI Inputs objects.....	153
19.7 Push Button objects.....	155
19.8 Generic KNX Inputs objects .....	156
20 ETS parameters .....	157
20.1 General.....	157
20.1.1 Parameterpage: General .....	157
20.1.2 Parameterpage: Behaviour.....	158
20.1.3 Parameterpage: Analysis and Service .....	159
20.1.4 Parameterpage: Special Functions .....	162
20.1.5 Parameterpage: IP Network .....	165
20.2 Broadcast.....	168
20.3 Groups .....	169
20.3.1 General Group1 (2.. 16) .....	169
20.3.2 Behaviour.....	172

20.3.3	Colour control .....	174
20.3.3.1	Colour Temperature .....	174
20.3.3.2	RGB .....	175
20.3.3.3	RGBW .....	176
20.3.3.4	XY Colour .....	177
20.3.3.5	Colour Temperature + RGB .....	178
20.3.3.6	Colour Temperature + RGBW .....	179
20.3.4	Analyse and Service .....	181
20.4	Single ECG .....	182
20.4.1	Single ECG General .....	182
20.4.2	ECG 1 (2.. 64) .....	183
20.4.2.1	Emergency Settings .....	187
20.4.2.2	Behaviour .....	188
20.4.2.3	Colour Control .....	190
20.4.2.4	Analysis and Service .....	193
20.5	Motion/Brightness Detector .....	194
20.5.1	Motion/Brightness General .....	194
20.5.2	Motion .....	194
20.5.3	Brightness .....	196
20.5.4	Light Control .....	197
20.6	Generic DALI Inputs .....	200
20.7	Push Buttons .....	203
20.7.1	Push Buttons Pair .....	204
20.7.2	Push Buttons Single Button .....	205
20.8	Generic KNX Inputs .....	208
21	API/MQTT .....	209
21.1	General .....	209
21.2	MQTT Basics .....	209
21.2.1	MQTT Client .....	209
21.2.2	MQTT Broker .....	209
21.2.3	MQTT Security .....	209
21.3	MQTT Communication .....	209
21.3.1	Client-Id .....	209
21.3.2	Topics .....	210
21.3.3	Topic Structure and payload .....	210
21.4	MQTT Configuration page .....	210
21.4.1	Connection .....	211
21.4.2	Subscription .....	211
21.4.3	Publication .....	211
21.5	Publication and Payload .....	211
21.5.1	Root Level ([location]/client-id) .....	211
21.5.1.1	Sub-Topic status .....	211
21.5.1.2	Sub-Topic info .....	212
21.5.1.3	Sub-Topic statistics .....	212
21.5.1.4	Sub-Topic config .....	213
21.5.1.5	Sub-Topic energy .....	214
21.5.1.6	Sub-Topic power .....	214
21.5.2	Group Level ([location]/client-id/group/index) .....	214
21.5.2.1	Sub-Topic status .....	214
21.5.2.2	Sub-Topic colour .....	215
21.5.2.3	Sub-Topic statistics .....	215
21.5.2.4	Sub-Topic energy .....	215
21.5.2.5	Sub-Topic power .....	215
21.5.3	Ecg Level ([location]/client-id/ecg/index) .....	216
21.5.3.1	Sub-Topic status .....	216
21.5.3.2	Sub-Topic colour .....	216
21.5.3.3	Sub-Topic alarm .....	217
21.5.3.4	Sub-Topic energy .....	217
21.5.3.5	Sub-Topic power .....	217
21.5.4	Sensor Level ([location]/client-id/sensor/index) .....	217

21.5.4.1	Sub-Topic presence .....	217
21.5.4.2	Sub-Topic brightness.....	218
21.5.4.3	Sub-Topic temperature.....	218
21.5.4.4	Sub-Topic humidity .....	218
21.5.4.5	Sub-Topic co2.....	218
21.5.4.6	Sub-Topic voc.....	218
21.5.4.7	Sub-Topic sound .....	218
21.5.4.8	Sub-Topic genericUnsigned .....	219
21.5.4.9	Sub-Topic genericFloat .....	219
21.5.5	KNX Datapoint Level ([location]/client-id/knx/index) .....	219
21.5.5.1	Sub-Topic knx.....	219
21.5.6	Emergency Level ([location]/client-id/emergency/index).....	220
21.5.6.1	Sub-Topic emstatus.....	220
21.5.6.2	Sub-Topic emtest .....	220
21.6	Commands and Payload .....	221
21.6.1	Group Level (cmd/[location]/client-id/group/index).....	221
21.6.1.1	Sub-Topic status.....	221
21.6.1.2	Sub-Topic value.....	221
21.6.1.3	Sub-Topic tc.....	222
21.6.1.4	Sub-Topic colour .....	222
21.6.2	ECG Level (cmd/[location]/client-id/ecg/index).....	222
21.6.2.1	Sub-Topic status.....	222
21.6.2.2	Sub-Topic value.....	222
21.6.2.3	Sub-Topic tc.....	222
21.6.2.4	Sub-Topic colour .....	222
22	FAQ .....	224
22.1	Web Access .....	224
22.2	Security.....	224
22.3	DCA .....	225
23	Disclaimer for cyber security .....	226
24	Open Source Software used in the DALI Gateway Pro .....	226
24.1	Open Source used in Firmware.....	230
24.2	Open Source used in DCA .....	231

# 1 General product information

## 1.1 Using the application program

This application program description outlines the function of the SpaceLogic KNX DALI Gateway Pro software for devices equipped with firmware version 2.0.0 or higher. .

Product family: Lighting

Product Type: Gateway

Manufacturer: Schneider Electric

Name: SpaceLogic KNX DALI Gateway Pro

Order number: MTN6725-0101

Number of communication objects: 2429

When using KNX Secure:

Number of secure group addresses for use: 1000

Number of communication partners: 100

## 1.2 Impact and compatibility

The new firmware V2 requires the ETS application V2 and the DCA V2.

The already existing ETS version 1.x is not valid and cannot be downloaded into this firmware V2.

Likewise the new ETS V2 cannot be downloaded into an old firmware V1.x. During such a download, a message appears describing an incompatible firmware version.

### 1.2.1 Impact for Web Access

A total of 2 sessions (login) can be managed.

One session is reserved for admin user, the other can be used as a normal user.

## 1.3 DALI Bus system properties

The cross-functional DALI-Bus (DALI = Digital Addressable Lighting Interface) is a system used to control electronic ballasts (ECGs) in lighting technology. The specifications of the DALI communications interface are set in the international norm EN62386.

The DALI Bus enables the receipt of switch and dim commands. In addition, the DALI can be used for the notification of an failure status such as light or ECG failures or for other light status information. In line with the latest DALI standard, devices with emergency light function (EN 62386-202) are also supported. Status and operating mode of emergency lights can be monitored and different prescribed testing procedures can be performed.

Via the connected control device / gateway (Master), up to 64 individual DALI ECGs (Slaves) can be connected in a DALI segment. When the DALI is commissioned, the ECGs receive an automatically generated 3 byte long address. Based on the long address a short address between 0 and 63 is assigned during the further commissioning process. As the address assignment is automatic, the device order is

random. The individual ECGs/lights therefore need to be identified during the further commissioning process (see below).

The addressing of individual ECGs in the system is either based upon the short address (individual addressing) or upon a DALI group address (group addressing). For this purpose, any number of ECGs within a segment can be assigned to up to 16 groups. The group addressing in the DALI system guarantees that switch and dim processes of different lights within a system are performed simultaneously without imposition of time delays. In addition to short and group addresses, the light values of individual DALI ECGs can also be merged into scenes and addressed via scene addresses.

For a detailed description of the DALI system, please see the DALI handbook at  
--> <https://www.digitalilluminationinterface.org>

## 1.4 SpaceLogic KNX DALI Gateway Pro product features

The SpaceLogic KNX DALI Gateway Pro is a multi-master application controller for controlling electronic ballasts with DALI interface via the KNX installation bus. It supports ballasts according to EN 62386-102 ed1 (DALI1), devices according to EN 62386-102 ed2 (DALI2), as well as DALI2 motion sensors and light sensors according to EN 62386-303 and EN 62386-304.

The device transforms switching and dimming commands from the connected KNX system into corresponding DALI telegrams, or status and event information from the DALI bus into KNX telegrams.

The SpaceLogic KNX DALI Gateway Pro has a DALI output which can control up to 64 ECGs. In addition, up to 8 DALI2 motion detectors with light sensors or other physical sensors, as well as up to 8 DALI2 push buttons can be connected. Multi-master operation according to EN 62386-103 ed2 is permitted.

The required power supply for the connected ECGs and motion sensors and input devices (push buttons) is provided directly from the device. Additional DALI power supplies are not required. When using sensors supplied via the DALI bus, it must be ensured that the current consumption of all connected DALI devices does not exceed the guaranteed value.

The device is available in a 4TE wide DIN rail housing for direct installation in an electrical distribution board. The bus connection is made via a standard bus connector. Mains and DALI lines are connected via screw terminals on the device. Ethernet is connected via an RJ45 socket.

Per gateway the ECGs can be controlled in 16 groups. In addition to the group control the SpaceLogic KNX DALI Gateway Pro also allows individual control of up to 64 ECGs.

In addition to the control of all standard operating devices, the SpaceLogic KNX DALI Gateway Pro also allows the operation of single battery emergency lights (EN 62386-202). Emergency lighting systems with central battery are also supported.

**The special interface for configuring the DALI segments is designed as a DCA (Device Control App) for the ETS5. Please make sure that the corresponding etsapp is installed in addition to the product database knxprod. This is available for download at Konnex or on the Schneider Electric website.**

In addition to the pure gateway functions, the SpaceLogic KNX DALI Gateway Pro offers numerous additional features:

- Addressing of 16 DALI groups and/or individual addressing of up to 64 individual ECGs
- Flexible DALI commissioning concept: directly on the device, via integrated web server or in the ETS5 (DCA)
- Coloured light control with the support of Device Type 8 (DT-8) ballasts and control via communication objects
- Coloured light control depending on ballast Sub-Type:
  - Colour Temperatur (DT-8 Sub-Type Tc)
  - XY Colour (DT-8 Sub-Type XY)
  - RGB (DT-8 Sub-Type RGBWAF)
  - HSV (DT-8 Sub-Type RGBWAF)
  - RGBW (DT-8 Sub-Type RGBWAF)
- Automatic, time-controlled setting of light value, light colour and colour temperature (also for Human Centric Lighting applications) for groups and/or individual ECGs
- Automatic change of colour temperature depending on the light value (Dimm-To-Cold)
- Control of colour temperature via communication object for DT6, warm white and cool white
- Broadcast objects for controlling all connected ECGs simultaneously (also possible for color values)
- Various operating modes for groups such as continuous mode, night mode, staircase mode
- Integrated operating hours counter for each group and/or individual ECG with alarm when end of life is reached
- Individual fault detection with objects for each individual luminaire/ECG
- Complex error evaluation on group/device level with error number and error rate calculation
- Error threshold monitoring with individually adjustable threshold values
- Scene module for up to 16 scenes, which can be assigned to KNX scenes 1..64 as required
- Extensive scene programming, including the possibility of dimming scenes
- Setting of colour in DT-8 luminaires via scenes for groups and/or individual ECGs
- Effect module for sequence controls and lighting effects including colour adjustment in DT-8 luminaires
- Test mode for systems with emergency luminaires supplied by central battery
- Support of single-battery emergency lights DT-1
- Support of test procedures for emergency lights with time and date stamp
- "Quick Exchange Function" for easy replacement of individual defective ECGs
- "Energy saving function" allows the ECG power supply to be switched off when light is switched off via additional switching actuators
- Integrated web server with extensive options for commissioning and maintenance
- Integrated "Visualization" via Web browser for direct operation and display
- Cross-device summary of errors in the entire system
- Manual operation of group and broadcast telegrams via operating keys and display on the device
- Signalling of error states and status diagnosis via LEDs and display on the device

Additional Features from Version 2.0.0:

- Call scenes and effect from time control module
- New- and Post Installation directly into groups or if short address is externally configured
- Reading the GTIN number of ECGs and input devices for easy identification
- New IoT Interface: API/MQTT
- Webaccess limitation to 1 user and 1 admin account
- Adjustable Soft-Start-Behaviour
- Enhanced concept for "virtual input devices" allows assignment of several instances
- Extended functionality of the motion detector with 2-point light control
- DALI2 push-buttons are supported as input devices with numerous KNX functions.
- Generic Type DALI2-Input Devices are supported for various physical sensors
- Internal linking of input devices directly with DALI groups
- Support of Energy Reporting according DALI Part 252.

## 1.5 Operating concept

The device is equipped with 3 operating interfaces:

- Keys and display on the device
- ETS + DCA
- web interface

It is recommended to select "one" operating concept for commissioning and later configuration.

**Note:** The operating concepts cannot be used in parallel or simultaneously.

Any change in the ETS or DCA will only become visible when the website is called up again (renewed login). The web page already called up cannot update these changes online.

It is also important to make sure that changes made with the website are only visible in ETS after a synchronization in DCA, see chapter [9.5 Synchronization between web pages and DCA](#)

Since an ETS download with the corresponding configuration of parameters and group assignment is necessary, the following procedure is recommended:

- Parameter setting and group assignment with ETS
- Commissioning of the ballasts and allocation to groups with the DCA
- Configuration of scenes, effects and timer commands with DCA or web interface
- Status and error diagnosis with the DCA or web interface.

## 1.6 Scope of delivery and commissioning

The scope of delivery of the DALI Gateway Pro consists of:

- DALI Gateway Pro with pre-installed software
- Operating and installation instructions
- 1x heat shrinkable tubing 1.2 x 2cm for additional insulation of the bus cable

The following connectors can be found at the bottom of the REG casing (from left to right):

- KNX bus coupler
- RJ45 plug for Ethernet
- 230VAC connector

The following connector can be found on top:

- DALI connector



The factory setting of the DALI Gateway Pro

- IP address assignment: DHCP
- Physical address: 15.15.255

A KNX project created with the ETS programming software should be available for the initial commissioning.

### Error LED

The Error LED indicates the following errors:

- KNX connection is interrupted.
- DALI failure
- Internal error

## 2 KNX Secure

The KNX standard has been extended by KNX Secure.

This enables the transmission of encrypted information within KNX. This allows secure encryption of ETS downloads as well as communication via objects.

**Note:** There are special conditions to be kept in mind when using secure devices in ETS. Please refer to the corresponding web pages on the KNX website (<https://www.knx.org>)

The SpaceLogic KNX DALI Gateway Pro is equipped with a KNX Secure Stack.  
In order to use a device "safely", the ETS project must first be protected with a password.

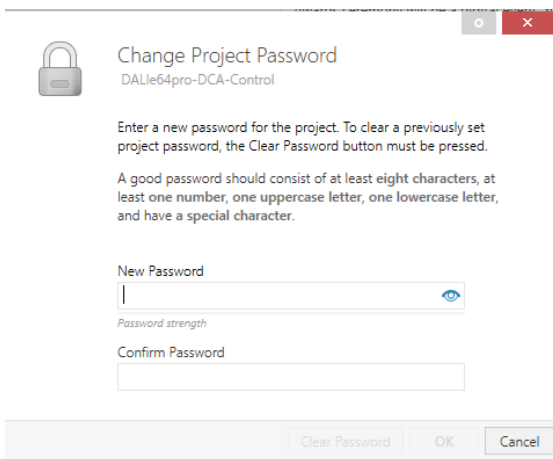

**Note:** "Safe" devices can only be downloaded with an interface that supports longer telegrams (long frames).

### 2.1 Secure Usage

In the ETS the secured usage is shown in the properties as follows:

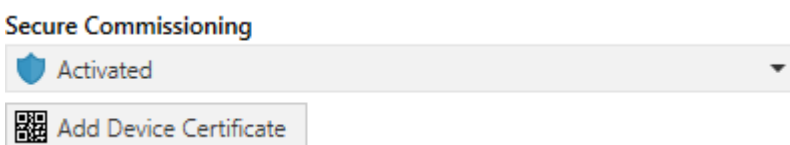

Subsequently, the device certificate must be read in for each "safe" device. For this purpose, the camera is available as a QR Code Reader or the code must be entered manually:

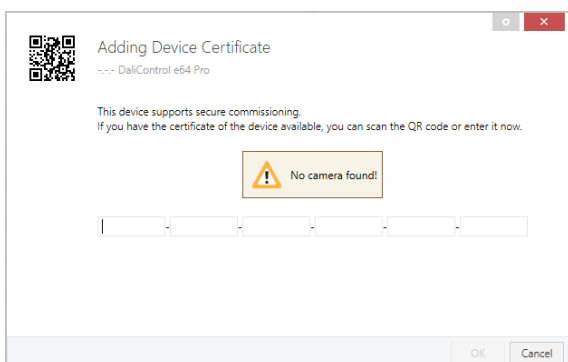

The certificate consists of the serial number and an initial key FDSK (Factory Default Setup Key).

This code is only used for initial commissioning with the ETS. During the first download this key is replaced by the ETS. This prevents unauthorized persons from gaining access to the installation despite knowing the initial key.

This initial key is printed on the device label both as a QR code and in text form.

**Note:** A "removable" sticker is also supplied, which the user can place in his documentation.

**Note:** The unit is designed to use up to 1000 group addresses in secure communication. Up to 100 communication partners are possible to communicate with the SpaceLogic KNX DALI Gateway Pro via secured group communication.

## 2.2 Unsecure Usage

However, the SpaceLogic KNX DALI Gateway Pro can also be configured as an "traditional" device in the ETS, as was previously the case. In this case, group communication with other devices can also be carried out as usual. In this case no encrypted ETS download takes place.

### Secure Commissioning

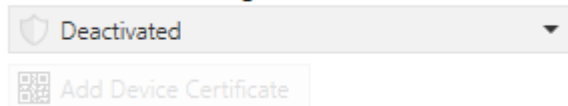

## 2.3 Master-Reset

A master reset must be carried out so that the device can be returned to the manufacturing state and thus the initial key can be reactivated.

The following procedure must be followed for this:

1. Remove KNX connector
2. Keep commissioning KNX push button pressed
3. Add KNX connector
4. Keep KNX push button pressed for long time (~7sec) after KNX power supply connection.

### 3 Colour control

The SpaceLogic KNX DALI Gateway Pro also supports ECGs for colour control (device Type 8 according to EN 62386-209). Such devices allow for multi-channel colour control (RGB) and thereby enable the mixing of a light colour or the setting of a colour temperature via DALI.

#### 3.1 Features of DALI device Type 8

ECGs for colour control (DT-8) are offered by a range of manufacturers. Usually these devices allow for the direct control of LED modules with multi-colour LEDs. The most common ones are modules with LEDs in the three colours red, green, blue (RGB), as well as modules with two different white tones (Tunable White).

**Attention:** DT-8 ECGs for the sub-Type PrimaryN are not supported by the DALI gateway.

Occasionally LED modules with a further integrated white channel (RGBW) are offered on the market. Whilst it is, of course, possible to control the different colour channels individually, each via a separate DALI control device for LEDs (Device Type-6), this solution has the disadvantage, that each of these devices is assigned a separate DALI short address. This means that two (tunable white), three (RGB) or even four short addresses are required to control a module. With a maximum number of 64 available short addresses per DALI segment, the number of lights that can be used would be greatly reduced. With a DT-8 device, however, only one short address is required for all colour channels and the maximum possible range of 64 lights can be controlled. The DALI standard EN 62386-209 defines different colour control methods for DT-8 devices. Normally, a certain device supports only one of these possible methods. Therefore please pay attention to the specifications of the respective device or lamp manufacturer.

#### 3.2 Colour display via XY coordinates

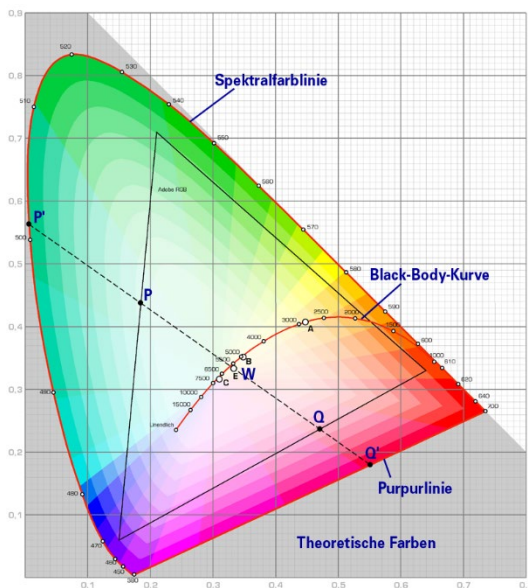

The display of a colour via two nominated coordinates in a so-called colour space is a common method. By means of the x-y coordinates any point in this space is accessible and as a result any colour can be defined. The diagram used in the DALI standard is the colour space chromaticity diagram according to the 1931 CIE standard. (Cambridge University Press) which is shown in the following graphic.

Figure: University of Cambridge press, source Wikipedia

In devices that support the x-y coordinates method, the colour is set via two values between 0.0 and 1.0. However, because of the physical properties of an LED, even in an RGB LED module not every colour is practically possible. In practice, it is common to set the value which is closest.

**Note:** Please pay attention to the instructions of the ECG or lamp manufacturer. Usually the xy values, which are supported by the lamp, are specified here. XY values outside of the specified range can lead to incorrect values and non-reproducible colours.

### 3.3 Colour display via colour temperature

One subset of all the possible colours in the colour space displayed above, are the different white tones.

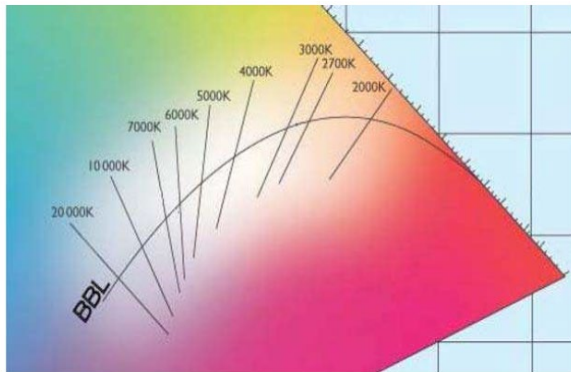

The white tones are found on one line across the whole colour space. The points on this so-called black-body-line (BBL) are usually defined via a colour temperature in Kelvin. This makes it possible to exactly determine the white tone of a light between warm and cool with just one value. The colour temperature principle is therefore perfect for the control of white light fixtures (tunable white).

Figure: University of Cambridge press, source Wikipedia

DT-8 operating devices set the required colour temperature on an LED module by mixing cool and warm white LEDs. Of course, as before this is only possible within certain physical limits. With today's LED modules colour temperatures between 2000 and 8000 Kelvin are common.

### 3.4 Colour display via 3 or 4 colour channels (RGBWAF)

Principally, a colour is always created by mixing different individual colours (different white tones, RGB or RGBW). A colour can therefore also be displayed based on the mixing ratio of different single colours, e.g. 50% red, 0% green, 60% blue.

Unlike the methods described above, the colour definition in this case is not exact but depends greatly on the specific, physical attributes of the LEDs used to create the colour (wave length, intensity). Nonetheless, the indication of the primary colour percentages within a system is useful for the relative description of a colour. In some DT-8 ballasts, the colour is set by defining 3 (RGB) or 4 values (RGBW) between 0 and 100%.

According to DALI standard EN 62386-209, up to six colours (RGBWAF) can theoretically be drawn upon. The SpaceLogic KNX DALI Gateway Pro, however, only supports a maximum of 4 colours, in line with the ECGs that are currently available on the market.

### 3.5 Colour display via 2 DT-6 LED types

This allows a colour temperature to be set via 2 DT-6 groups. For example, LED strips with a warm colour (3000K) are assigned to a master group and LED strips with a cold colour (6000K) to a slave group.

With this assignment, only the master group with one colour temperature is controlled.

The device automatically calculates the control of the warm and cold LED to achieve the desired colour.

---

## 4 Operating modes

Each group and individual ECG offer different operating modes that can be set individually on the parameter page.

### 4.1 Normal mode

In normal mode, ECGs can be dimmed and switched without restrictions both via individual and group control. The control of each ECG and each group is based on three communication objects (switching, dimming, value setting). For DT-8 ECGs numerous additional objects for light colour control are available.

An ECG can only be assigned to a single DALI group. The SpaceLogic KNX DALI Gateway Pro does not support multi-group assignments on DALI level. If such assignment is required, please use KNX communication objects for this purpose. Separate status objects inform about the switch and value status both at group and individual ECG level.

### 4.2 Permanent mode

If you would like to run an individual ECG or a whole group permanently with a certain light value, (e.g. a permanently lit corridor or workshop) you can choose the permanent mode option. The ECG or group are automatically set to the required value after you program or switch on the gateway. Switch and dim objects remain hidden. Light status, failure and service functions, however, are also available in permanent mode.

**Note:** Should a device in this mode not be running at the preset light level because of a special operation (e.g. identification process on the device display) or failure (e.g. ECG was without power when the gateway was started) the light level is automatically corrected after 60 seconds.

### 4.3 Staircase mode

This operating mode is supported by groups, only.

In staircase mode, the value set via a switch, dim or value telegram is automatically changed to the switch off value after a programmable time. The lights can be switched off immediately or in 2 steps (within a minute) or through dim-down (within a minute).

In staircase mode, each additionally received telegram re-starts the internal timer. The lights switch off when the timer runs out after the most recently received telegram. The staircase mode can be disabled or enabled via an additional object. If the staircase mode is disabled, the group behaves like in normal mode and does not automatically switch off. If the mode is disabled whilst the switch-off timer is already running, the timer stops and the group remains at the currently set value if the mode is enabled again, the timer starts again from the beginning.

---

## 4.4 Night mode

The night mode corresponds largely to the staircase mode. The only difference is that the automatic switch-off is dependent on the central night object of the gateway. If the night object is not set (day), the group behaves like in normal mode. If the object is set (night), the group either switches off after a programmable time or it goes into permanent mode.

## 4.5 Panic mode (special case)

The panic mode can be activated via a central object for the whole gateway. All groups and ECGs that have been enabled for panic mode, permanently switch to a programmable panic light value on receipt of the object. They can no longer be controlled individually. When the panic mode is switched off, the devices return to the previous light value or the switch on / switch off value and can again be controlled individually.

**Note:** When the panic mode is active, both the scene and time scheduling module are de-activated.

## 4.6 Test mode for central battery emergency lights

Through its internal function the SpaceLogic KNX DALI Gateway Pro supports installations with central battery emergency luminaires. Any ECG (except for those of the self-contained battery Type) can be configured as an emergency light (even when assigned to a group). You can choose a test time between 15 minutes and 4 hours. If the gateway receives the central battery test object, the respective lights change to a programmable value for this time period. They can no longer be switched or dimmed via the corresponding objects. The discharge time and capacity of the central battery can thereby be tested under pre-defined conditions.

So that individual ECGs within a group can no longer be switched via group telegrams or scenes, the group assignment is dissolved for the duration of the test mode. When the test has finished, groups and scenes are automatically re-programmed onto the ECGs. Should the gateway lose power during the test mode, the unprogrammed devices are marked and automatically programmed on return of the power supply. The test mode, however, does not continue. It has to be re-started.

When the test mode terminates normally, the devices return to the previous light value or the switch on / switch off value and can again be controlled individually.

## 4.7 Operating mode hierarchy

Some of the individual operating modes described above have higher functions and roles for the operation of the system as a whole. A prioritisation or hierarchy of operating modes is therefore required. The central battery test mode has the highest priority followed by the panic mode. The permanent, normal and night modes have the same priority level in the hierarchy.

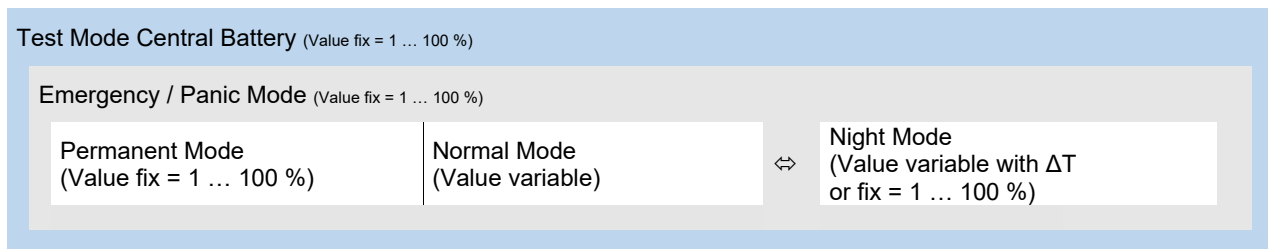

By default manual mode is enabled and can always be used for service and maintenance functions. However, it can be disabled by means of ETS parameters, see chapter: [20.1.4 Parameterpage: Special Functions](#)

## 5 Light Control Module

From version 2.0.0, the SpaceLogic KNX DALI Gateway Pro offers the possibility of directly implementing a 2-point light control with the connected DALI-2 light sensors (motion detectors with light sensors). The control ensures that the light is switched on when the light value measured by the sensor falls below a minimum setpoint value. A corresponding communication object is available for the output as a 1 bit or alternatively as a 1 byte value.

The control can also act directly internally on the 16 DALI groups of the unit. In this case, it is not necessary to link the communication object. The selection and setting of the main groups and, if necessary, up to 2 subgroups, as well as the weighting of the subgroups is adjusted via ETS parameters.

If the direct control of internal DALI groups is used by the light control, it can be set via a parameter whether a change of the light value of the group (main or subgroup) is to be carried out by a command, outside of the light control, i.e.:

- Group On/Off, Dimming , Value setting via communication object.
- Group part of a scene and scene activation
- Group in panic or test mode
- Broadcast switching, value setting

deactivates the control or switches off the automatic mode.

In such a case, the control must first be reset to automatic mode via the communication object Disable/Automatic. In addition to activating the control via the object, the control can also be activated automatically after an adjustable period of time (fallback mode). The status of the control (active/not active) is provided via the existing status object.

Attention: Higher-priority operating modes (see chapter 4.7) of the respective group, i.e.

- Emergency/panic operation
- Test mode central battery
- Permanent mode

as well as a blocking via the blocking object of the group, always prevent the control from changing the group, even if the above-mentioned parameter is not set.

The activation of the light controller can also be realized depending on a presence detection of a linked DALI2 motion detector. In this case, the light is only switched on if the setpoint is undershot and the detector has reported "Presence". If the sensor reports "Vacant", the light remains off even if it is too dark.

The light switch-off behaviour of a light controller with presence detection can also be set via a parameter. Either the controller always switches off the light if there is sufficient extraneous light (> setpoint) or the controller only switches off when the "Vacant" state is reached (i.e. switching off is independent of the light value).

In the first case of a 2-point light control, it should be noted that light switched on by the control requires a threshold value shift. If, for example, artificial light is added when the daylight threshold value falls below 200 lux, the threshold value is exceeded again by the artificial light component. So that the controller does not immediately switch off again, the added artificial light must be taken into account by the controller and the threshold value raised accordingly. For this purpose, the light value is measured before and after switching on and the difference is added to the threshold value. The light is only switched off again if the correspondingly corrected value is exceeded.

Since it takes a few seconds for the new light value to reach the final value, depending on the type of lamp and ballast used, the delay time until the second measurement after the light is switched on can be set via parameters.

It should be noted that a maximum delay of 15 seconds (default 6 seconds) can be selected here. If the group is set in such a way that the final value is not reached within this time (e.g. with dimming time at switch-on > 15 seconds), the control cannot function because no correct artificial light component is taken into account.

If a deactivated controller is reset to automatic mode with artificial light already switched on (e.g. after deactivation by manually switching on the group) via the communication object Disable/Automatic, no

threshold value adjustment takes place. In this case, only the previously adjusted threshold value (parameter modified by object value if applicable) is relevant for the 2-point control. In corresponding lighting conditions, it is therefore possible that the manually set light is first switched off after activation, as the artificial light component is already above the light threshold. If, however, the daylight component is below the threshold after switching off, the controller will switch the light on again. After switching on, the artificial light component is taken into account and the light remains on due to the threshold shift. If the light switch-off behaviour of a light controller with presence detection is set to "Switching off is independent from the light value", this effect of brief switching off cannot occur because switching off is not caused by the light value but exclusively by the "Vacant" state.

## 5.1 Light Control Diagnostic

To monitor the current status of the light control, a diagnostic window with detailed information can be opened in DCA View.

This operation requires a connection to the DaliControl Gateway and a previous executed "State Sync" operation. By pressing "State Sync" all diagnostic data will be read from the device.

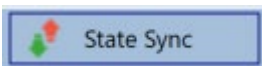

By a right click in one of the 8 motion detectors in the left tree the diagnostic window can be opened. The prerequisite for this is that this motion detector has been activated for light control in the ETS parameters.

Light Control Diagnose
— □ ×

Last sync datetime: 8/14/2023 1:09:37 PM

<b>Type:</b>	Motion + Brightness	<b>Motion On/Off:</b>	Off
<b>Controller deactivated due to</b>		<b>Control Output:</b>	Off
-> <b>Manual override:</b>	No	<b>Light Value:</b>	288
-> <b>Disable object:</b>	No	<b>Setpoint Value:</b>	300
-> <b>Light sufficient:</b>	No	<b>External Trigger:</b>	Off
<b>Movement Flags:</b>	00000000	<b>Brightness Flags:</b>	00000001

No.	Short Addr	Inst No.	Type	Error	Status	Resolution
0	0	0	Motion	False	0	2
1	0	1	Brightness	False	288	14

Refresh
Close

**Note:** The diagnostic window (Light control diagnosis) is only visible if you have activated a light control in the ETS.

This diagnose windows displays all interesting values of the light control system:

Type:	Type of control unit, usually Motion + Brightness
Controller deactivated due to: <ul style="list-style-type: none"> <li>• Manual override</li> <li>• Disable object</li> <li>• Light sufficient</li> </ul>	Which action cause the deactivation of the controller
Movement Flags	Which connected instance does indicate a movement. In case of 5 connected instances for each one bit can be set and indicate that movement has been detected.
Motion On/Off	Shows the motion status
Control Output	Shows the controller output status
Light Value	Shows the current light value
Setpoint Value	Shows the current setpoint value
External Trigger	Shows the status of the external trigger
Brightness Flags	Which connected instance does indicate a brightness value. In case of 5 connected instances for each one bit can be set and indicate that brightness has been detected.

In addition, information of all instances linked to the motion/brightness detector in the ETS is provided in the diagnosis window.

No.	Short Addr	Inst No.	Type	Error	Status	Resolution
0	0	0	Motion	False	0	2
1	2	1	Motion	False	1	2
2	0	1	Brightness	False	324	11
3	2	0	Brightness	False	563	10

Refresh

Close

**Note:** The values are not updated automatically. There is a manual “Refresh” necessary to update current values/status.

---

## 6 Analysis and service functions

### 6.1 Energy Reporting according to DALI Part 252

The SpaceLogic KNX DALI Gateway Pro supports device type 51 ECGs to read energy or power values directly from the ECGs and make the information available on the KNX.

The standard defines a minimum cycle time of 30 seconds for reading out the energy data. In the event of a status change, the correct consumption should therefore be available after this time at the latest.

Depending on the ECG manufacturer, this time can vary and be adjusted via an ETS parameter.

The SpaceLogic KNX DALI Gateway Pro also automatically calculates the consumption per group and per device.

### 6.2 Recording operating hours

The SpaceLogic KNX DALI Gateway Pro allows for the operating hours (burning time) of each lamp to be individually recorded for each group and individual ECG. The internal recording is precise to the second. The value is available externally via communication objects. (DPT 13.100).

The operating hours recording is independent from the dim value. This means any light value > 0% contributes to an increase in the operating hours of a group. The counter can be reset (when a lamp is changed). To reset the counter, the value 1 is written on the communication "reset operating hours".

A maximum value can be configured for each running time counter (life span), which activates an alarm object on the KNX bus. This information can be used for maintenance purposes.

**Attention:** In accordance with KNX standards, the operating hours are sent in seconds. However, these can be changed into other units.

### 6.3 Failure recognition at ECG level

A major advantage of DALI technology is the individual recognition of light failures or faulty ECGs. The SpaceLogic KNX DALI Gateway Pro supports this function.

For error analysis, the DALI Gateway cyclically interrogates all connected ECGs for ECG and lamp faults. The polling cycle can be configured. If the time is 1 second (standard setting) and there are 64 connected ECGs, the complete process of scanning all ECGs for light and ECG failures takes 128 seconds (1 second per ECG and failure Type). It can therefore take up to about 2 minutes before a fault that has occurred is recognised. For each ECG, a communication object is available to send the information to the KNX bus (1Bit or 1 Byte object). In addition, the failure status can also be checked on the DCA in the ETS.

Furthermore, the error status of all TOEs is clearly displayed on the web page of the gateway.

**Attention:** If the parameter setting is "Polling cycle for failures" = "No query", all failure queries are disabled. No ECG or converter failures or lamp failures are recognised in this case. This setting is only useful for service purposes when an extreme reduction of the DALI busload is required.

## 6.4 Failure analysis at group level

If ECGs and / or converters are merged into groups, numerous group-specific failure data is available in addition to the individual ECG data. For this purpose different communication objects are available for each group. In addition to general information such as whether there is an failure within a group and of what Type, the complete number of faulty devices within the group and the failure rate can be listed via a communication object. An alarm object is sent when a certain failure rate is exceeded. A complex object with a summary of the data further adds to the analysis options.

For details of group-specific communication objects, please see the communication objects description below in chapter: [19.3 Group objects](#)

The failure information for a group is also clearly displayed on the web site of the integrated web server.

## 6.5 Failure analysis at device level

Failure analysis objects similar to those at group level are also available at device level (i.e. for all ECGs connected to the gateway). The failure rate or number of faulty ECG in the whole DALI segment can be made available via communication objects. In contrast to the group level, at gateway level the percentage and number of failures can be broken down further according to failure Type. The alarm threshold for the failure rate can be individually set for ECG, light and converter failures.

For further details regarding the communication objects, please see the communication objects description in chapter: [19.1.2 General objects analysis and service](#).

As before, the failure information for the entire gateway is also displayed on the website.

## 7 Webserver commissioning and operation

### 7.1 Commissioning and operation

In addition to the DCA, you can also easily commission the DALI via the integrated web server. For this purpose connect the SpaceLogic KNX DALI Gateway Pro directly to the IP network. An RJ-45 socket is located above the KNX bus connector at the bottom left-hand side of the device.

Use a standard patch cable to connect the device to a switch, hub or router of the IP network. You can also use a WLAN access point as network coupler. This means you can commission the DALI via a portable note book, tablet PC or mobile phone.

Once the network is physically connected, you need to assign an IP address to the SpaceLogic KNX DALI Gateway Pro to enable access via the web browser. By default, all Schneider Electric devices with an IP interface are set to DHCP address assignment. If there is a DHCP server in the network the device automatically receives an IP address after initialisation. This address is shown on the device display. If no DHCP service is available or if you would rather use a fixed IP address, you must set the address either via ETS. You may also need to configure the sub-net mask and standard gateway (for direct access via the Internet). Those two parameters can only be configured in the ETS.

Once the IP address has been assigned correctly, load the device website via any common web browser.

**Attention:** Please, take care that you open a https connection via <https://<ip>>

HTML5 functionality is required for all browsers used. Google Chrome, Mozilla Firefox and Microsoft Edge have been tested in the current status (version of this document).

### 7.2 Safety aspects

The communication with the web server in the SpaceLogic KNX DALI Gateway Pro is encrypted via HTTPS.

Each device has a self-signed SSL certificate. This certificate contains among other things the name of the owner, his public key, the period of validity and the name of the certification authority.

The SSL certificate existing in the device was signed by the certification authority and can be verified with the corresponding public key of the certification authority.

In order for the SSL certificate of the device to be considered trustworthy, the browser or PC must know the certificate of the certification authority in order to confirm the trustworthiness. The operating system manages a list of all "trusted certification authorities", so-called CA root certificates.

If a secure connection is then established in the browser, the browser first checks whether this certificate can be confirmed by a CA root certificate. If the check is positive, a closed lock is usually displayed in the browser line to confirm security.

If the device certificate cannot be confirmed, a security warning will be issued and must be accepted manually.

The SpaceLogic KNX DALI Gateway devices have their own CA root certificate and all device certificates are derived and confirmed from this CA root certificate.

If this CA root certificate is imported on the operating system, the browser recognises all DaliControl devices as "trustworthy", as the individual device certificates are confirmed by this CA root certificate.

The device makes the CA root certificate available via an administrator page. The procedure for loading this certificate and then installing it on the PC is explained in the chapter: [7.3 Import of the CA Root Certificate](#).

## 7.3 Import of the CA Root Certificate

As already explained in the security aspects, the device enables the CA root certificate to be loaded.

To do this, please log in on the website as "Administrator" and select the menu item "ADMINISTRATOR". Below the actions is the entry "Load the root certificate". This allows the root certificate to be stored on the PC. See also chapter: [7.7.2 Download Issuer Certificate](#).

To import this certificate, please proceed as follows:  
Install security certificate:

- Right-click the exported file in the location where it was saved and select "Install Certificate".
- In the next step, the storage location is queried. Here you can select "Current User" or "Local Computer". Click on "Next".
- Here the option "**Save all certificates to the following store**" should be selected and "Browse" should be clicked.
- Select the **Trusted Root Certification Authorities** folder as the certificate store and OK.

After completion, the message "The import process was successfully completed" is displayed.

**Note:** In order for the browser to check this new issuer certificate when calling up a website, it must be restarted.

## 7.4 User Accounts

Two user accounts are managed in the SpaceLogic KNX DALI Gateway Pro.

A user with all rights as administrator and a normal user with restricted rights.

A total of 2 sessions (login) can be managed.

One session is reserved for admin user, the other can be used as a normal user.

### 7.4.1 Administrator

This user role has all rights. In particular, commissioning, i.e. new installation or subsequent installation of the ballasts or motion detectors, is only permitted to the administrator.

**Important:** Only one administrator can be logged on at a time.

### 7.4.2 Normal User

The rights of the normal user can be set in even more detail with the ETS. Basically, commissioning is blocked for the user.

By default, however, it has all operating rights to switch lights, configure scenes, effects, schedules and view status information.

#### Restriction of rights for the user account

User is allowed to control lights  No  Yes

User is allowed to change scene configuration  No  Yes

User is allowed to change effect configuration  No  Yes

User is allowed to change schedule configuration  No  Yes

User is allowed to view emergency reports  No  Yes

## 7.5 Password management and login

For security reasons, access to the web server in the device is blocked by default. Therefore an ETS configuration and a download is necessary before using the IP interface.

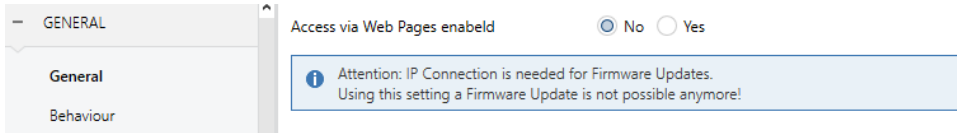

After setting the network configuration, the web server can be activated. By default, the following accesses are provided with the corresponding access data.

Account	Login Name	Password
Admin Account	admin	dali
User Account	user	user

**Note:** Please note that after the download the passwords for the accesses must be changed again into secure passwords.

After that the passwords should not be reset with the ETS. It is therefore strongly recommended to set the corresponding parameter to "No" before the next ETS download:

### Webpage Access

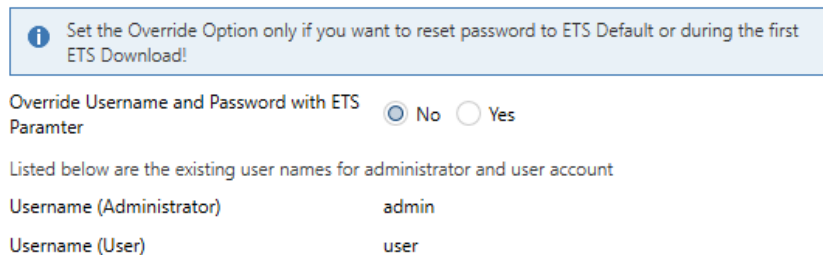

After the first ETS download and the parameter "Overwrite login name and password" set to "Yes", the authentication is carried out with these values. Afterwards a prompt appears asking you to change the password.

The following rule must be observed here:

- At least 8 characters
- Upper and lower case
- At least one digit
- At least one special character

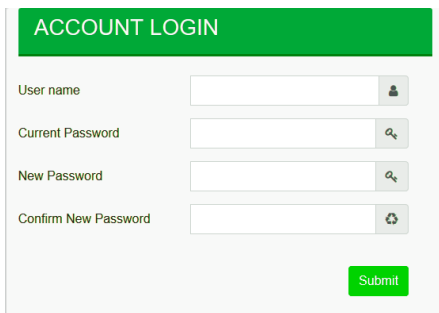

Afterwards you can log in with the changed password.

**Note:** The user name is only defined with the ETS configuration.

Accordingly, it would be possible to assign a customer-specific login name for the administrator or the standard user.

**Note:** However, it is recommended to use the default names "admin" and "user".

### 7.5.1 Password forgotten

If the password is forgotten, the password can be reset via an ETS download with the ETS and the corresponding parameter, see figure.

#### Webpage Access

**i** Set the Override Option only if you want to reset password to ETS Default or during the first ETS Download!

Override Username and Password with ETS Paramter  No  Yes

**i** Password has to be changed on web page!

Account	Login Name	Password
Admin Account	admin	dali
User Account	user	user

This is followed by changing the password as described in the previous chapter.

## 7.6 Log-In the website

Once the IP connection to the gateway is established, the website can be accessed by entering the IP address in the address field of the browser. The website can be accessed with user or administrator rights.

**Attention:** Please, take care that you open a https connection via <https://<ip>>

When logging in as "user", the function of the website is restricted and configuration commands are blocked. This login should be used if the website is used for visualization and operation. If the website is also used for DALI commissioning, the login as administrator is required. All following illustrations and descriptions of the web pages refer to the administrator representation.

In the login window, the user name is used to decide whether the administrator role or the normal user role should be activated.

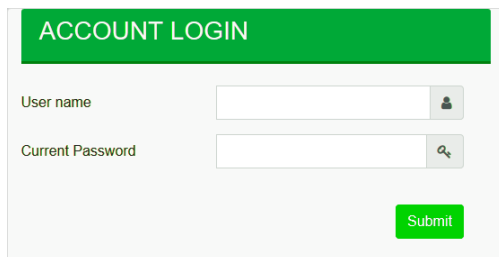

The screenshot shows a web form titled "ACCOUNT LOGIN" with a green header. It contains two input fields: "User name" and "Current Password". The "User name" field has a small person icon to its right, and the "Current Password" field has a magnifying glass icon. A green "Submit" button is located at the bottom right of the form.

The user name is defined in the ETS. By default, "admin" and "user" are used.

**Note:** Under certain circumstances it is advisable to save the login data in the browser. You will be prompted to do so. With the next call the data are then already pre-filled.

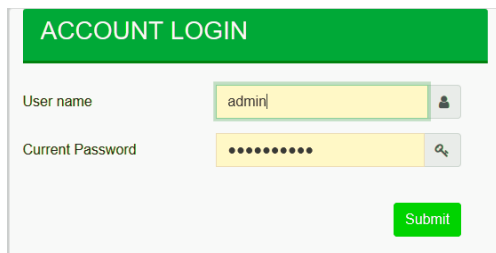

The screenshot shows the same "ACCOUNT LOGIN" form, but the "User name" field is pre-filled with "admin" and the "Current Password" field is pre-filled with a series of dots. The "Submit" button remains at the bottom right.

**Note:** If there is no login after 1 minute, a subsequent login is reported as a "forbidden request" for security reasons. The correct URL must then be loaded again and the user must log on again.

**Note:** For security reasons, access to the website will be blocked for 1 minute if 4 incorrect login attempts are detected.

**Important:** Up to four sessions can be managed. If all four sessions are logged in with "User", the role of "Admin" is also acknowledged with the response "No Session available". In this case the logged in "Users" must first be logged out.

## 7.7 Administration of the website

For administration, please log in on the website as "Administrator" and select the menu item "ADMINISTRATOR".

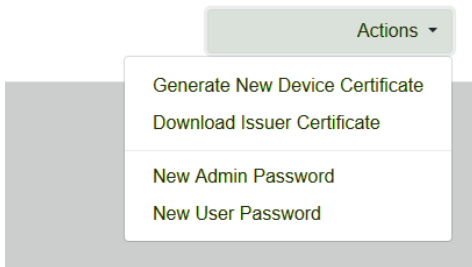

### 7.7.1 Generate New Device Certificate

The device is delivered with a certificate. This certificate has a lifetime of 5 years. There are different reasons to renew the certificate:

- The IP address of the device has changed (after initial commissioning)
- The certificate is no longer valid and must be renewed

To regenerate a certificate, you must be logged in to the administrator role. Under the tab "Administration" you have the possibility to generate a new certificate.

After the certificate is created, the device must be manually restarted for the new certificate to become active.



### 7.7.2 Download Issuer Certificate

With this action the issuer certificate can be downloaded to the PC.

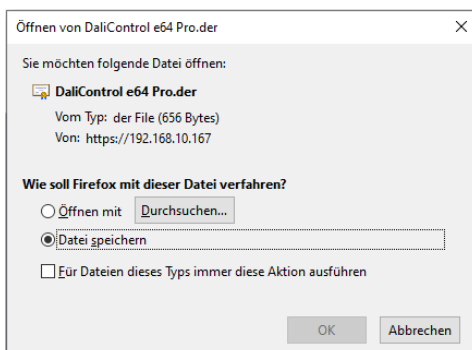

Please select a storage location in order to install the issuer certificate on the PC afterwards, see [7.3 Import of the CA Root Certificate](#). The certificate will be saved in a ".der" format.

### 7.7.3 Update Firmware

Here the firmware of the device can be updated. For security reasons, the PIN is requested which has already been configured in the ETS.

Administrator

Please enter the pin to unlock the device

PIN

Submit

Only if the PIN is entered correctly, the next window is displayed to select the firmware package.

Administrator

Please select a file for upload and afterwards press submit.  
Please note, the upload may take up to 2 minutes.

Choose file...

Submit

**Note:** The firmware update can take up to 2 minutes.

Under unpredictable conditions, the transmission can be interrupted with an error. The following errors could be reported. Please contact the manufacturer.

- 701: Device is not unlocked via PIN
- 702: Signature could not be verified
- 703: Device type does not match
- 704: Manufacturer does not match
- 705: Request ID is invalid
- 799: General error

### 7.7.4 New Admin Password

In this menu item the password for the administrator can be changed.

Administrator

Change login credentials for: admin

Current Password

New Password

Confirm New Password

Submit

### 7.7.5 New User Password

In this menu item the password for the user can be changed

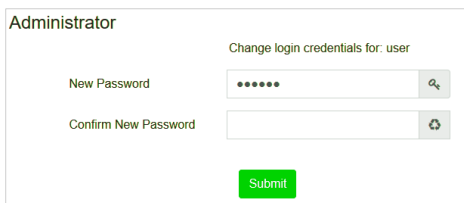

Administrator

Change login credentials for: user

New Password

Confirm New Password

## 7.7.6 API/MQTT Access Configuration

Settings and instructions for using MQTT are explained in chapter: [21 API/MQTT](#). When using the API/MQTT, please observe the safety instructions in chapter: [23 Disclaimer for cyber security](#).

## 7.8 Language Setting on Website

The language English is selected on delivery. The language can be changed directly on the device using the buttons, see submenu chapter: [18.2.1 Sub-menu language](#)

**Attention:** Only the languages English and German are provided on the website.

## 7.9 Calling the start page

The website consists of a header and a menu bar, which are always visible. The header displays the logo, the installation location, if defined in the ETS configuration, and the login name.



The Info button displays a popup window with the version, a link to the technical documentation and a link to use the OpenSource sources.

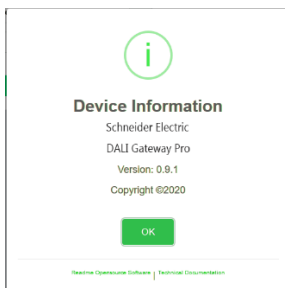

The menu line consists of the entries:

- Information
- Commissioning (only in the admin login)
- Settings
- Configuration
- Diagnosis
- Administrator (only in the Admin login)

Initially, the overview page with the basic information of the device is displayed:

The screenshot shows the 'DALI Gateway Pro' web interface. At the top, there is a navigation menu with 'INFORMATION', 'COMMISSIONING', 'SETTINGS', 'CONFIGURATION', 'DIAGNOSIS', and 'ADMINISTRATOR'. Below the menu, the following information is displayed:

- Serial Number: 00ef.00000107
- MAC Address: 00-05-26-00-01-07
- Individual Address: 1.5.008
- Firmware: 0.9.1

The 'Failure Status' section contains a table with columns for Lamp, ECG, Converter, KNX, and DALI. Each column has a green circle indicator, signifying that all components are operational.

	Lamps	Ecgs	Converter
Count	7	6	1
Failures	0	0	0
Failrate	0%	0%	0%
Tot. Failrate	0%		

The following properties of the DALI Gateway are displayed in the upper line:

- Serial number
- Mac address
- KNX address
- Firmware version
- DNS name

The current error situation is also displayed. A distinction is made between the following types of error:

- Lamp fault
- ECG Error
- Converter error
- KNX Error
- DALI error

The table below shows the number of connected devices and their error rate.

## 7.10 Actions on the website

Different actions can be performed on the website. A distinction is made between configuration commands such as new installation and switching commands.

Acknowledgement after processing is absolutely necessary for configuration commands. If this cannot be received because of errors, the process is aborted after a timeout of 5 minutes.

## 7.11 Automatic log-off

An inactive session, i.e. a login as user or administrator without active operation, is automatically logged off after 5 minutes. After this time, the login window appears again. This is particularly useful for the administrator session, so that it is not blocked indefinitely.

**Note:** Mouse movements, keyboard entries and clicks are considered active operation.

## 8 System diagnostics

A system with several DALI gateways allows a simple automated overview of the fault status of all connected gateways. The complete overview is available in each gateway and can be displayed on the website.

When a gateway is restarted, it reports with status information and is automatically transferred to the list of other devices. The current status is automatically sent with every error status change. Further parameter settings are described in the next chapter.

### 8.1 Requirements and Function

To activate the system diagnostics, the corresponding parameter must be set in the ETS.

Special Functions	System Diagnostic via IP Network
IP Network	Enable System Diagnostic <input type="radio"/> No <input checked="" type="radio"/> Yes
+ G1,	<div style="border: 1px solid #ccc; padding: 5px;"><b>i</b> Ensure that the webservice is accessible to show System Diagnostic results. Therefore, enable access in the Page "IP Settings".</div>
+ G2,	<div style="border: 1px solid #ccc; padding: 5px;"><b>i</b> Ensure that all gateways on the same system are working with the same Diagnostic Multicast Address</div>
+ G3,	System Diagnostic Multicast Address <input type="text" value="224.0.218.201"/>
+ G4,	Device Name <input type="text" value="DALIControl e64 Pro"/>
+ G5,	Send Status at least all <input type="text" value="60 Minutes"/>
+ G6,	Delete inactive entries from the list after <input type="text" value="1 Day"/>

All gateways that are to communicate with each other must be configured with the same multicast address. Each event (value change and error message) is automatically sent to the group of participating gateways. This allows each gateway to store and monitor the status of the other gateways. This data is only stored temporarily and is collected again after a restart.

Another parameter can be used to define the time after which the status should be sent if no change has occurred during this time and no automated event is reported.

The inactive entries (inactive gateways) are deleted after a predefined time, which can be set via ETS.

**Note:** After restarting a gateway, the device status is initially sent to this multicast address. Subsequently, at each change, or after the time set in the ETS. The system diagnostics broadcast service cannot be fully protected against spoofing. If in doubt about the correct device segment status, please login to the corresponding device webinterface directly.

The parameters are also described in chapter [20.1.4 Parameterpage: Special Functions](#).

## 8.2 Viewing the Diagnostic Information

The diagnostic view is displayed on the website.

To do this, select "Diagnosis" in the main menu and "System Overview" in the following submenu.

Name	IP	Lamp	ECG	Converter	KNX	DALI	Tot. Failrate	
Dali Device 2	192.168.10.208	●	●	●	●	●	0 %	i
DALIControl e64 Pro	192.168.10.210	●	●	●	●	●	0 %	i

In a list all DALI Gateways that are working in the same system and are enabled according to the requirements are displayed.

The following information is displayed:

- Name of the DALI Gateway
- IP address of the DALI gateway
- Lamp Error
- ECG Error
- Converter error
- KNX Error
- DALI error
- Failure rate

Clicking the Info button displays further information about the status of the device in a detail window.

DALIControl e64 Pro	192.168.10.210	●	●	●	●	●	0 %	i
Serial Number:	00ef.00000008	Individual Address:	1.5.8	Firmware:	0.9_05	Project Id:	Building Id:	Zone Id:
	Lamps		Ecgs		Converter			
Count	7		6		1			
Failures	0		0		0			
Failrate	0 %		0 %		0 %			

## 8.3 Website access of other gateways

Each Dali Gateway in the list can be opened in a second browser tab by clicking on the IP address.

**Note:** The corresponding login data of the DALI Gateway must be available.

## 9 Installation and commissioning concept

The following graphic shows the steps required for the new installation and commissioning of a DALI gateway.

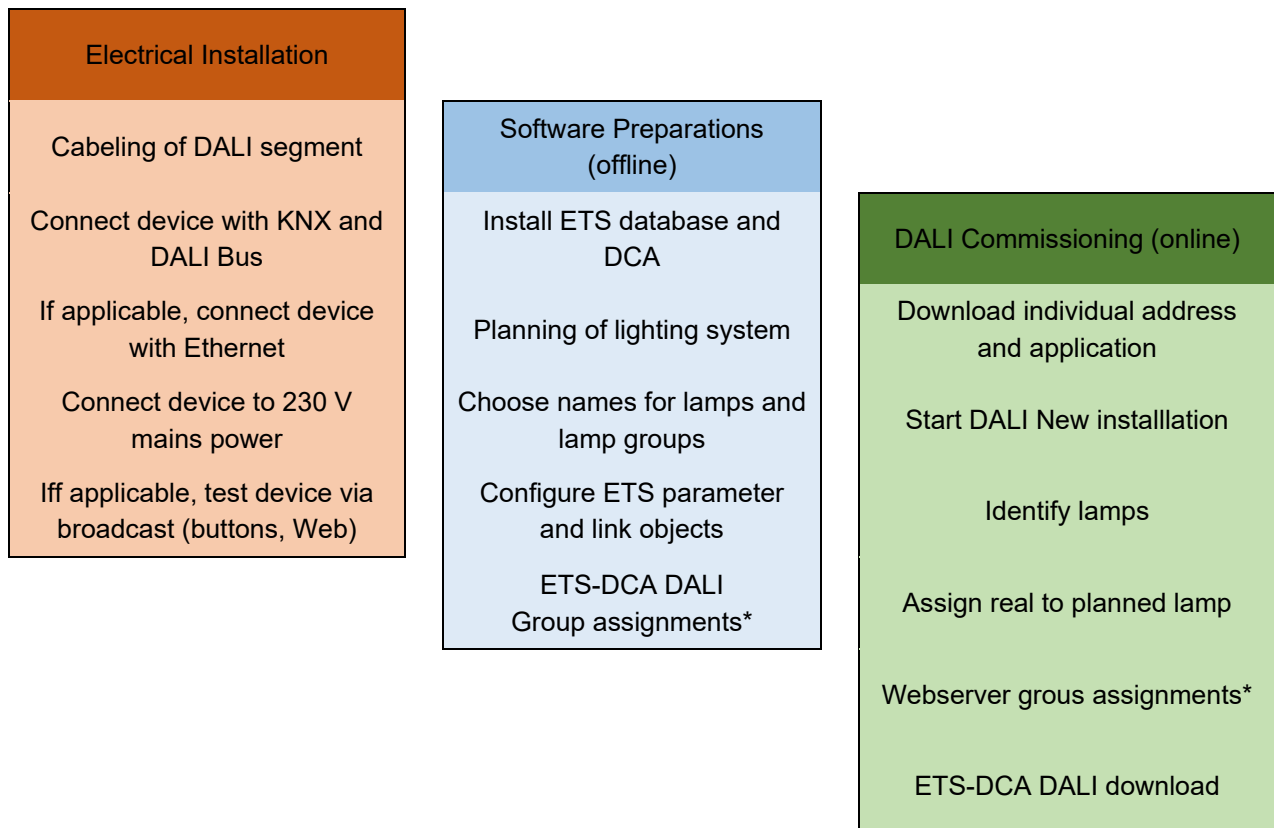

\* When commissioning via DCA the group assignment can already be done in the planning phase (offline). When commissioning via web server the system has to be on-line.

---

## 9.1 DALI New installation

After wiring the DALI segment (see mounting and operating instructions) and software preparations such as installation, planning and configuration (see below) which can be performed without connection to the DALI gateway (offline), you are ready to start a new DALI installation. A new installation is only possible with a connection to the DALI gateway and when the ECGs that are to be installed are connected and supplied with power.

As with every configuration process, the new installation is possible in a number of different ways:

- Configuration and execution via DCA (Device Control App) in the ETS5
- Configuration and execution via integrated web server (Ethernet network connection required)
- Configuration and execution via pushbuttons and display on the device

**Note:** Depending on the type of use, configuration data should be synchronized in the DCA, see [9.5 Synchronization between web pages and DCA](#)

If you start a new installation, the ECGs connected to the DALI gateway are reset and automatically recognised and programmed by the DALI gateway. During the programming process each ECG is assigned a short address between 0 and 63 based on a random long address. As the long address is generated randomly, the short addresses and lights need to be assigned afterwards (Exception: special case of new installation with externally configured devices, see below). The new installation makes the connected ECGs known to the gateway and enables the gateway to contact them via the short address.

**Note:** Please remember that every time a new installation is started, the ECGs are reset and thereby randomly allocated again. Any previous configuration is overwritten and deleted.

## 9.2 Identification and assignment of DALI ECGs

As the ECGs are assigned randomly following the new installation, individual ECGs need to be identified and assigned as required. During the commissioning process, the ECGs are usually identified by setting an ECG / lamp to flashing mode. This means that in the installation, the lamp can be identified visually so that it can be assigned according to the user's preference. Instead of flashing, lights can also be turned on/off.

For self-contained emergency lights according to DT-1, the identification is slightly different. As not all lights support switching on/off or may only switch on in case of power loss, the EN 62386-202 enables the activation of an identification status. When the gateway sets these ECGs to flashing mode, the identification status starts instead. The exact execution of this status is up to the manufacturer. Normally the control LED connected to the converter flashes red or red-green for a few seconds. Please refer to the instructions for the emergency lights or converters used.

After an ECG has been identified, it can be assigned to the previously planned ECG. Again there are different options for the assignment (DCA, web server, pushbuttons and display on the device). The different options are described in the following chapters.

### 9.3 ETS-App (DCA)

The application for the SpaceLogic KNX DALI Gateway Pro is based on the standard surface for the configuration of communication objects and parameters as well as a special surface for commissioning the DALI bus system. This special surface is designed as a DCA (Device Control App) for the ETS5.

All required program data are automatically created when the App is imported.

Click on the "App" button in the ETS5 footer and then select the "plus" button in order to add a new application to your ETS5 system:

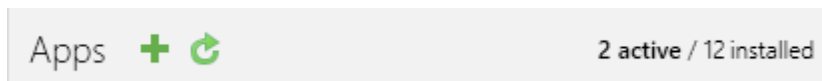

A file box will appear to select the ETS App for the SpaceLogic KNX DALI Gateway Pro:

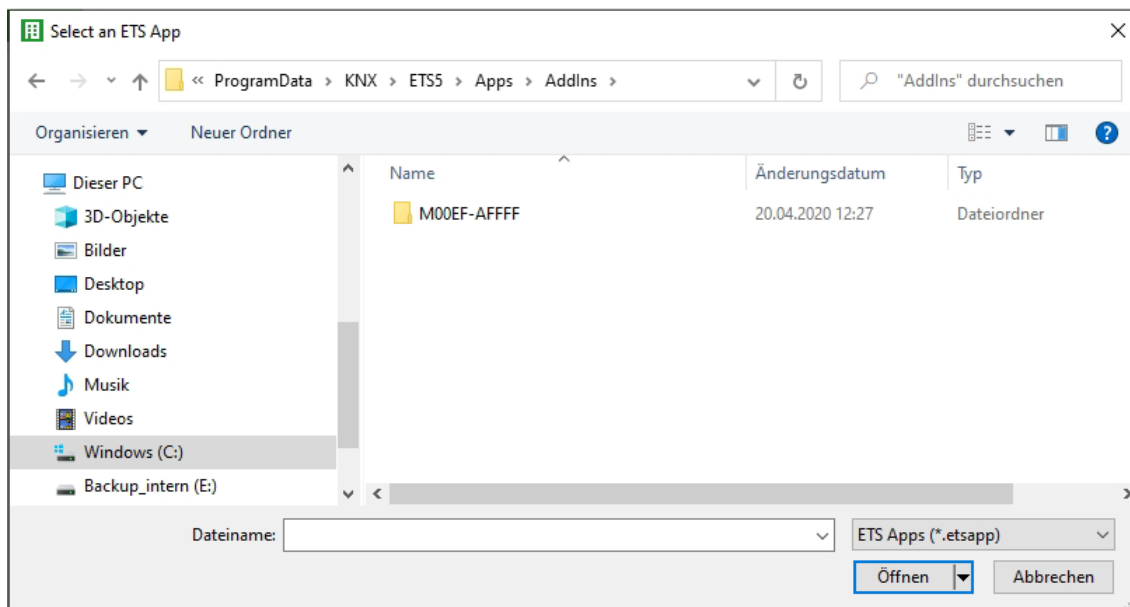

The application will now be installed and displayed in the list of all ETS5 apps.

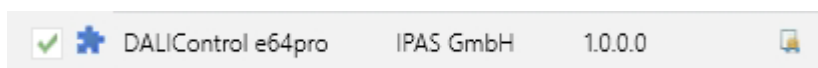

After the installation, the ETS has to be re-started. When the product is selected, an additional "DCA" tab is shown in the ETS5.

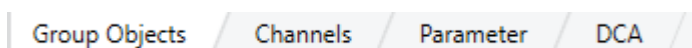

---

## 9.4 Parametrisation

The parameters and the corresponding group addresses can now be configured as with any other KNX product. Through the parameters, various operating modes can also be configured. These are described in more detail in the chapter. [4 Operating modes](#)

If a later use of the website is to be enabled, this must first be enabled in the ETS parameterization.

As the SpaceLogic KNX DALI Gateway Pro also supports colour control, future ECGs or groups with the desired colour control should be configured in ETS. Only in this way can the corresponding communication objects be made available.

In order to better identify the types of ECGs or groups both in the DCA and on the website, meaningful descriptive texts should also be defined for the ECGs and groups. These texts are also displayed in the list of communication objects.

The DALI specific configuration is performed in the DCA tab or by using the web-page. You should start by planning and naming the ECGs you want to use and by assigning them to the required groups.

This work can be carried out offline without connection to the KNX and without connection to the SpaceLogic KNX DALI Gateway Pro. The actual DALI commissioning is only possible online which means that a connection to the device is required. During this process the connected ECGs are recognised so that they can be assigned to the previously set up configuration.

After the assignment, the special DALI configuration has to be loaded onto the device by using the "Program" button in the DCA tab, see chapter: [11.1 DCA Commissioning](#) or [11.2 Website Commissioning](#).

Finally, the parameters and links to group addresses should be loaded onto the device. The device is now ready to use.

## 9.5 Synchronization between web pages and DCA

The web pages read the real data from the device each time they are called up and thus always display current configuration data. The DCA on the other hand works with the configuration data stored in the ETS.

If a configuration has been carried out with the web page or with the buttons directly on the device and you should continue working with the DCA later, a synchronization is necessary.

The menu items "Extras" and "Read device data" in the DCA are used for this purpose. More detailed information can be found in chapter: [17 DCA Extras](#)

---

## 10 Maintenance and expansion

### 10.1 Quick exchange of individual ECGs

When a DALI segment is commissioned, the short address, group assignment (if applicable) and other configuration data are programmed into the ECG's internal memory. If you need to replace an ECG because of a fault, you need to program this data onto the new device.

The SpaceLogic KNX DALI Gateway Pro offers a function that makes it possible to quickly and easily replace individual ECGs. The "ECG quick exchange" can be started from the DCA, the web server (when logged in as administrator) or on the device (pushbuttons, display) itself. The gateway first checks if any of the configured ECGs that are known to it have been reported as faulty. Then the segment is searched for new, unknown devices. If a new device is found, all configuration details of the old ECG are automatically programmed onto the new one and the installation is immediately ready for use again.

However, the ECG quick exchange only works if just one ECG within a segment is faulty and replaced by a new one. If several devices are faulty, the ECGs have to be identified and you must use the post installation function. Please also remember that the quick exchange is only possible for devices of the same Type. You cannot, for example, replace an ECG for self-contained battery emergency lights with a device for LEDs.

If a quick exchange is not possible because of any of the conditions above, the gateway terminates the process with an failure code. The different failure codes have the following meaning:

**Failure Type 7:** No ECG fault

**Failure Type 8:** More than one ECG faulty

**Failure Type 9:** No new ECG can be found

**Failure Type 10:** ECG has wrong device Type

**Failure Type 11:** More than one new ECG

### 10.2 DALI Post-installation

If you would like to expand an already commissioned DALI segment with new ECGs or would like to replace several faulty ones in the segment, please use the "post installation" function.

It is possible to activate "post-installation" on DCA or on the device itself (pushbuttons, display) and in the web browser when logging in as administrator.

When you start the post installation, the gateway first check on basis of DALI long address if all previously configured ECGs are still available in the segment. Usually ECGs that no longer exist or cannot be found are deleted from the gateway's internal memory. Should unavailable ECGs be kept (i.e. if parts of the system are not powered temporarily), the deleting can be avoided by using an additional option.

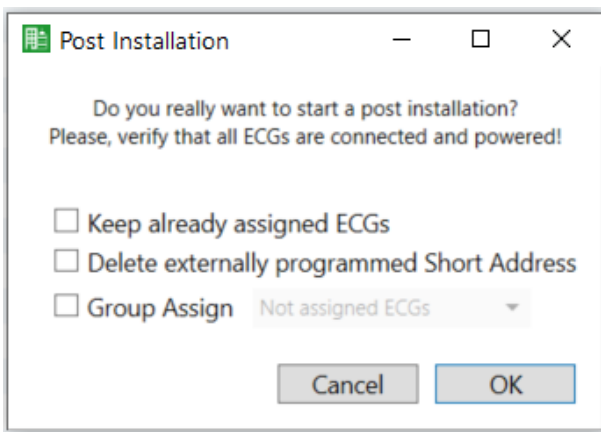

Usually ECGs have no short address and long address 0xFFFFFFFF on delivery by default. It might be possible, that ECGs got a short address even if long address is still 0xFFFFFFFF ( i.e. if an external tool was used for programming). In order to delete short address in this case please activate the control element "Delete externally programmed short address".

After verification the segment is searched for new ECGs. Newly found devices are inserted into any existing gaps or added on at the end.

**Attention:** Please remember that the maximum number of ECGs within a segment is 64

As the position (short address) of a newly found device is allocated randomly, you need to identify the lights after the installation and if required assign them to groups.

Alternatively, an automatic group assignment can be made by selecting the corresponding check box.

## 11 DALI Commissioning ECG

This chapter describes the commissioning with the DCA and the website

### 11.1 DCA Commissioning

Following the physical installation and wiring of the DALI ECGs and lights and the electronic commissioning, the ECG configuration needs to be prepared and planned in the DCA. For this purpose, open the commissioning page in the DCA:

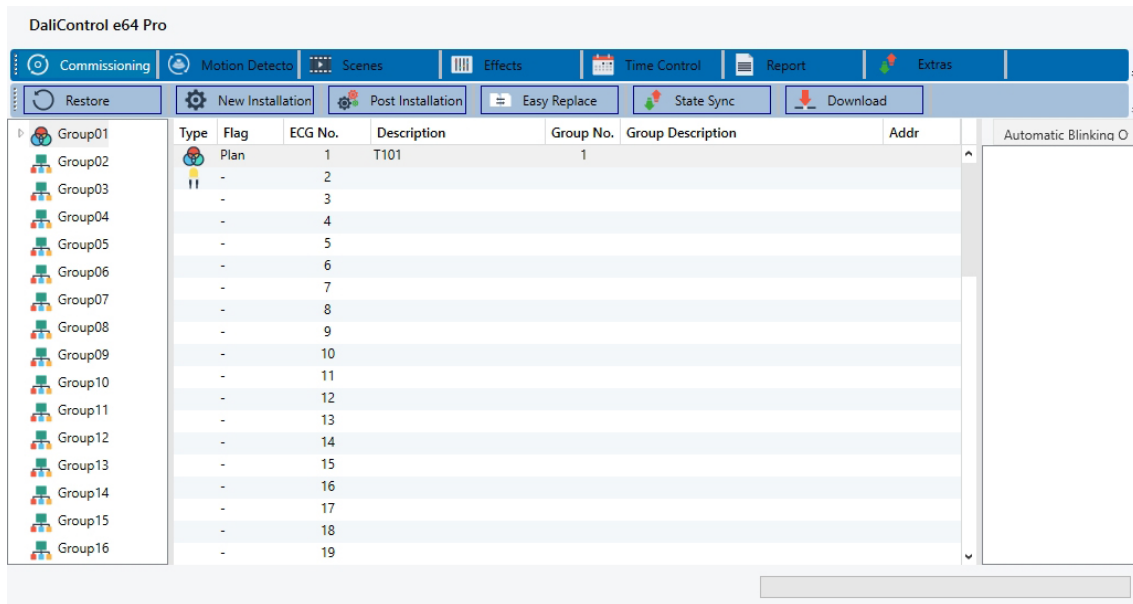

The group configuration is displayed in a tree structure on the left-hand side. The middle part shows a table for the ECG configuration and names. A list on the right-hand side shows the actual devices found in the system that have not yet been identified. During the planning phase the list is empty as the ETS is not yet connected to the system.

#### 11.1.1 Preparation

First you should plan and name the ECGs. Use the description field to enter a name (light number, room number, etc).

Type	Flag	ECG No.	Description
	-	1	T101

Double-click to display an editing window which will allow you to enter a maximum of 20 characters.

You should also set the correct ECG Type in the parameters (in this example LED Module is selected):

ECG 1, Description	T101
Group Assignment	Not Assigned
ECG Type	LED Module

This also leads to the corresponding display in the Type field in the DCA:

Type	Flag	ECG No.	Description
	-	1	T101

**Note:** The icon in the first column always reflects the ETS setting.

As a next step, you should define the group control Type in the parameters (in this example colour control via RGB):

G1, Room 111		Colour Control Type	RGB Colour
General		Selection of Object Type	RGB (3 Byte combined Object)
Behaviour		Colour changing Fading Time via Dimming	fast (10 Seconds)
Colour Control			

This leads to the corresponding display in the group tree in the DCA:

Type	Flag	ECG No.	Description
	Plan	1	T101

You can now assign the individual ECGs to the corresponding groups. Pull the ECGs via Drag&Drop onto the corresponding group in the tree on the left-hand side.

Type	Flag	ECG No.	Description	Group No.	Group Description
	Plan	1	T101	1	Room 111

If an ECG is assigned to a group by drag & drop, the corresponding group number is automatically displayed in the "Group No." field in the ECG configuration table. The icon of the group type is also automatically displayed.

**Note:** The icon in the first column of ECGs assigned to a group always reflects the type of the group, i.e. the icon of the ECG is replaced by the icon of the group.  
If a group assignment has to be removed, the command can be found in the context menu of the ECG configuration table:

On
Off
Blink
Unlink ECG from group

You can enter a user-friendly name in the neighbouring field "group description". ECG and group names are automatically displayed both in the group configuration tree (displayed in brackets) and in the descriptions of the ETS communication objects. Alternatively you can rename groups via the parameter page:

--- DaliControl e64 Pro > G1, Room 111 > General

- G1, Room 111	Group 1, Description	Room 111
General		

Easily recognisable names make it much easier for the system integrator when linking group addresses with communication objects.

47	G1, Switching, Room 111	On/Off
48	G1, Dimming, Room 111	Brighter/Darker
49	G1, Set Value, Room 111	Value
52	G1, Status, Room 111	On/Off
53	G1, Status, Room 111	Value
54	G1, Failure Status, Room 111	Yes/No
57	G1, Colour RGB, Room 111	Value
69	G1, Colour RGB, Room 111	Status

### 11.1.2 New installation

Once the planning, parameter setting and linking of group addresses have all been completed, the DALI segment can be commissioned. To do so, please connect the commissioning PC with the ETS to the KNX system via an interface (USB or IP). Once the connection is active, you need to program the physical address of the gateway. The communication between the plug-in and the gateway is based on the physical address.

Use the 'commissioning' page and the 'new installation' button to start the teach-in process of the connected DALI segment.

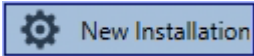

During the teach-in process all ECGs are automatically recognised and each ECG is assigned a short address from 0 - 63. Depending on the size of the connected DALI segment the process can take up to 3 minutes.

**Note:** It is possible to make a group selection directly during the new installation, so that a time-consuming 2nd step for the assignment in groups is not necessary.

**Note:** Alternatively, it is possible to take over and read in an already externally configured system, i.e. ECGs and group assignment already programmed with a short address.

**Attention:** It must be taken into account that with this option the corresponding ETS number is assigned to each short address, i.e. short address 0 is assigned to ETS index 1.

Example: 2 found ECGs with short address 5 and 6 are assigned to ETS index 6 and 7.

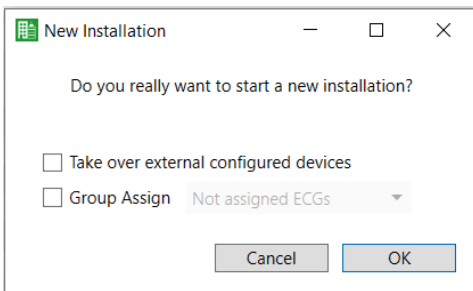

#### Group assignment

**Note:** It is possible to make a group assignment directly during the new installation, so that a time-consuming second step for the assignment to groups is not necessary.

#### Take over of already externally configured devices

**Note:** Alternatively, it is possible to take over and read in an already externally configured system, i.e. ECGs and group assignment already programmed with a short address.

**Attention:** It must be ensured that with this option the corresponding ETS number is assigned to each short address, i.e. short address 0 is assigned to ETS index 1.

Example: 2 ECGs found with short address 5 and 6 are assigned to ETS index 6 and 7.

A bar in the bottom right hand corner indicates how far this process has progressed. At the same time a display also informs about the current process and the number of ECGs that have so far been found.



Once the process is complete, all ECGs that have been found are displayed in the list of to-be identified devices on the right-hand side.

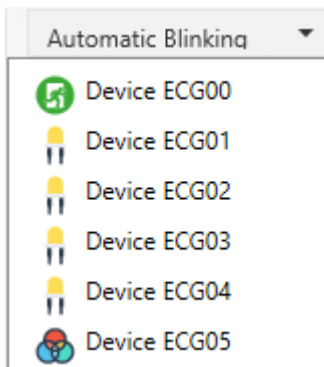

To identify the devices, switch the corresponding lamp on and off. If you select an ECG and press the right mouse button, a context menu appears from which you can select the required function.

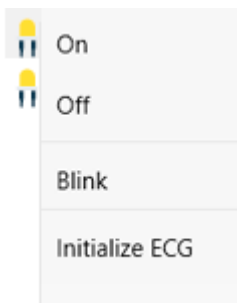

Alternatively, you can also select 'on' in the box 'Flash automatically'.

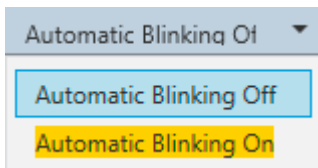

In this case, the flashing mode of an ECG starts by itself when a device is selected.

For self-contained battery emergency lights, selecting "flashing" activates the identification process of the light. Usually the status LED of the emergency light flashes during this process. Please pay attention to the description of the lights you are using. As the status LED does not work or is not visible for some lights, you can also start a function test. During the function test, the ECG usually switches the lights on for a few seconds.

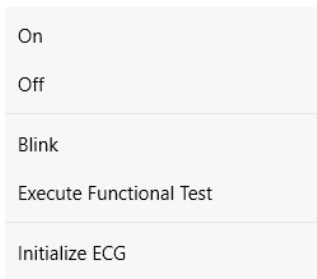

The context menu is also available at group level. During the identification process it might be useful to switch certain groups or all connected lamps on or off. You can also send broadcast commands via the context menu, in order to, for example, switch all lights on or off, see chapter: [11.1.5 Operating DALI devices](#)

Once an ECG has been identified, you can drag and drop it onto the previously planned element in the ECG configuration table.

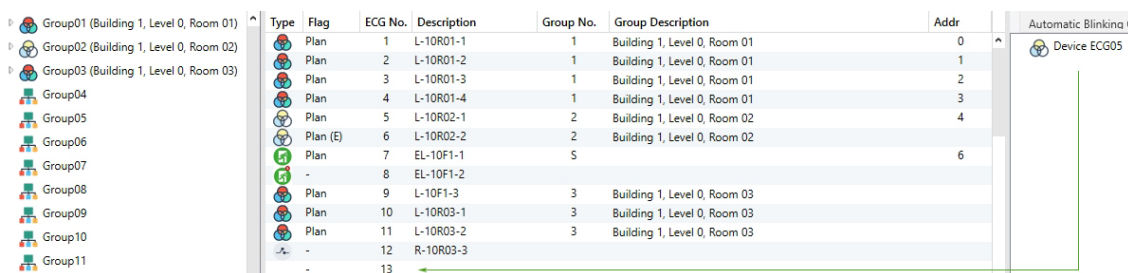

Once an ECG has been dragged into the ECG configuration table, it disappears from the list of non-identified ECGs. At the same time the 'PLAN' flag in the configuration table shows that the ECG has been assigned to the planned element. The last column in the table shows the real ECG short address.

**Note:** Please make sure that the short address is between 0 and 63. If an ECG has been wrongly assigned, it can be moved back to the list of non-identified devices using the same drag& drop mechanism.

Type	Flag	ECG No.	Description	Group No.	Group Description	Addr
Plan		1	L-10R01-1	1	Building 1, Level 0, Room 01	0
Plan		2	L-10R01-2	1	Building 1, Level 0, Room 01	1
Plan		3	L-10R01-3	1	Building 1, Level 0, Room 01	2
Plan		4	L-10R01-4	1	Building 1, Level 0, Room 01	3
Plan		5	L-10R02-1	2	Building 1, Level 0, Room 02	4
Plan (E)	E	6	L-10R02-2	2	Building 1, Level 0, Room 02	4
Plan		7	EL-10F1-1	5		6
-		8	EL-10F1-2			
Plan		9	L-10F1-3	3	Building 1, Level 0, Room 03	
Plan		10	L-10R03-1	3	Building 1, Level 0, Room 03	
Plan		11	L-10R03-2	3	Building 1, Level 0, Room 03	
-		12	R-10R03-3			
-		13				

The element in the configuration table is now available again (Flag: 'PLAN (E)' → Empty) and the ECG reappears in the list of non-identified devices from where it can now be moved to a different element if required.

**Important:** Please remember that at this point all operations that have been performed are only displayed in the work space. They are not immediately loaded onto the DALI gateway. To start the process of downloading the settings onto the gateway and the ECGs, you must press the 'Download' button.

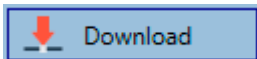

The download can take up to 1 minute. The progress bar informs about the current status. Once the download is complete, all previously planned ECGs are programmed in the system with the DALI configuration. The respective devices are marked with an "OK" flag in the ECG configuration table.

























Type	Flag	ECG No.	Description	Group No.	Group Description	Addr
OK	OK	1	L-10R01-1	1	Building 1, Level 0, Room 01	0
OK	OK	2	L-10R01-2	1	Building 1, Level 0, Room 01	1
OK	OK	3	L-10R01-3	1	Building 1, Level 0, Room 01	2
OK	OK	4	L-10R01-4	1	Building 1, Level 0, Room 01	3
OK	OK	5	L-10R02-1	2	Building 1, Level 0, Room 02	4
OK	OK	6	L-10R02-2	2	Building 1, Level 0, Room 02	4
OK	OK	7	EL-10F1-1	5		6

**Attention:** Please remember that the download on the 'commissioning page' only programmes the DALI configuration data onto the gateway and ECGs. The actual ETS application with parameter settings and group addresses still has to be downloaded onto the device either before or after the DALI identification and commissioning. This is done, as usual, via the normal download process in the ETS

### 11.1.3 ECG and group detail info

The following icons are displayed for the different ECG Types in the DCA:

A green background shows that this ECG has been configured as emergency light with central battery.  
See below.

		ECG Type 0: Fluorescent lamp
		ECG Type 1: Emergency light switchable or Emergency Light + Colourtemperature
		ECG Type 1: Emergency light non switchable
		ECG Type 2: Discharge lamp
		ECG Type 3: Low voltage lamp
		ECG Type 4: Incandescent lamp
		ECG Type 5: 0..10V Converter
		ECG Type 6: LED
		ECG Type 7: Relais module
		ECG Type 8: Colour module RGB
		ECG Type 8: Colour module tunable white
		ECG Type 8: Colour module tunable white + RGB

### 11.1.4 Failure and status display

During the commissioning, lamps/ECGs are identified visually (ON, OFF, flashing). It is therefore crucial that all lamps and ECGs operate correctly. If the gateway identifies a lamp or ECG fault during the installation process, the ECG concerned is highlighted in red. Failures are displayed for non-identified devices (right tree)

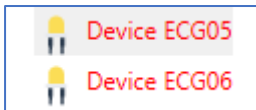

and for ECGs that have already been assigned (middle table).

Type	Flag	ECG No.	Description	Group No.	Group Description
	OK	1	L-10R01-1	1	Building 1, Level 0
	OK	2	L-10R01-2	2	Building 1, Level 1
	OK	3	L-10R01-3	S	
	OK	4	L-10R01-4	S	

Failures are marked with a red dot. Detailed information is available via double-click (see next chapter).

**Note:** If the lifetime of a lamp, provided that a limit has been set in the ETS parameters, exceeds the value, the ECG will be marked with a blue dot..

	OK	1	1 RGB
	OK	2	TC

As the view is not automatically updated and as it may take a few minutes for the DALI gateway to recognise a fault, we recommend that you press the 'Status Sync' button a short while after the installation.

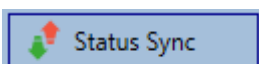

This ensures that the displayed status is updated with the actual status and any failures that may have been detected in the meantime are displayed correctly.

**Attention:** If an ECG failure already exists during the search process of the initial installation, the device is usually not detected. This means that the number of ECGs found does not correspond to the number that was expected. ECG failures are only displayed in the manner described above if the ECG concerned has been previously programmed and is known to the gateway.

In addition to ECG failures, further ECG info is exported or displayed.

This information includes:

- Long address
- Short address
- Device Type
- Device subType (important for colour ECGs DT-8)
  - TC: Temperature Colour
  - XY: XY Colour
  - RGBW: RGB or HSV Colour
- Device subType (important for emergency ECGs DT-1)
  - SW: switchable emergency lights
  - NSW: non switchable emergency lights
- Failure status

For DT-8 ECGs with colour temperature control the following are also displayed:

- Min. temperature
- Max. temperature

Press the "Status Sync" button to export and update the information.

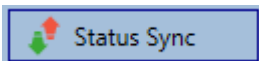

The process can take a few seconds:



#### 11.1.4.1 ECG info in the right-hand side tree

Additional information for the ECGs is displayed via tooltip:

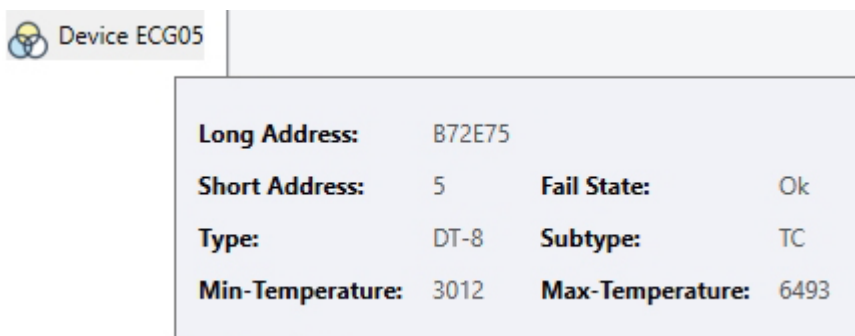

To activate the tooltip, hover over the position with the mouse.

#### 11.1.4.2 ECG info in the ECG table

Double-click to open another window with further details:

	<b>Long Address:</b>	B72E75		
	<b>Short Address:</b>	5	<b>Fail State:</b>	Ok
	<b>Type:</b>	DT-8	<b>Subtype:</b>	TC
	<b>Min-Temperature:</b>	3012	<b>Max-Temperature:</b>	6493

**Important:** The icon in the detail window shows the real ECG Type. Please make sure that the ETS definition is the same as the actual Type.

Further information:

- Long address
- Real short address
- Type
- Sub-Type
- Failure status
- Min. temperature (only for sub-Type TC)
- Max. temperature (only for sub-Type TC)

### 11.1.4.3 Group Info in the group tree

Additional information for the group is displayed via tooltip in the group tree.

<b>Value:</b>	0%	<b>ECG Count (Failed):</b>	3 (0)
<b>Operation Hours:</b>	0	<b>Converter Count (Failed):</b>	0 (0)
<b>Lifetime:</b>		<b>Fail Rate:</b>	0%

### 11.1.5 Operating DALI devices

DALI devices can be directly controlled in five different ways.

- **Broadcast:**

In this case telegrams that all participating devices react to are sent to the DALI bus.

The commands are executed by all ECGs even if they have not yet been commissioned. Therefore these commands work independently of the status of the DALI system.

- **Group Control:**

In this case, group telegrams are sent to control a particular group. For this process to work correctly, the ECGs need to have been assigned to groups and the configuration has to be downloaded onto the gateway.

- **ECG Control:**

In this case, ECGs can be individually controlled.

- **Emergency (Converter) inhibit**

Use the context menu in the group tree on the left-hand side to disable converters.

If the power supply for the connected emergency lights is turned off within 15 minutes after activating the converter inhibit mode, the lights are turned off instead of changing into emergency mode. This operating mode may be necessary during the commissioning and installation process to prevent constant emergency lighting and battery discharge.

- **Emergency (Converter) Start Functional Test**

Use the context menu in the right-hand side tree or the list to start a function test with converters.

- **Initialize ECG**

This function is only available in the tree on the right. This can be used to completely delete an ECG. After this action, it is no longer present and can only be found by renewed post installation. Therefore, this action must be confirmed by the operator:

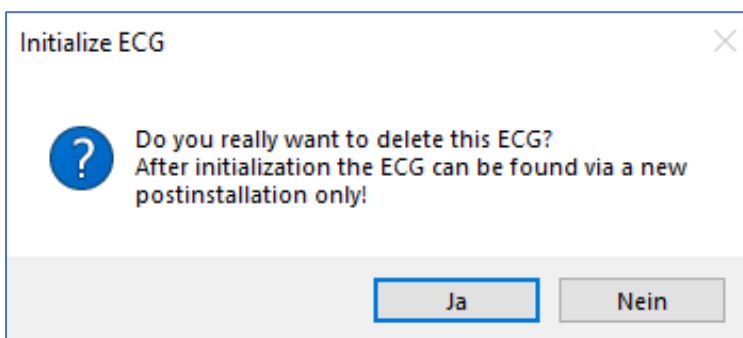

The DCA offers different options to activate these commands. The DALI must be commissioned and a connection to the gateway must be available for all of the options.

Group menu in the left-hand side tree:

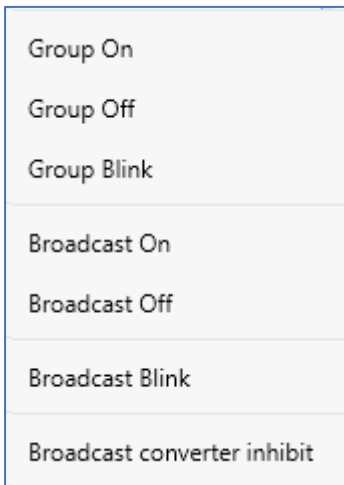

Context menu in the ECG table:

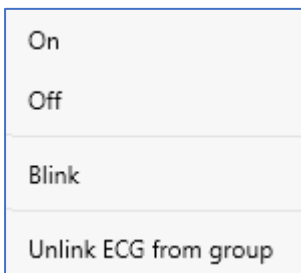

ECG menu in the right-hand side tree:

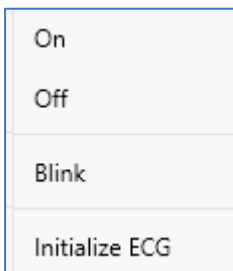

### 11.1.6 Post Installation

If you would like to expand an already commissioned DALI segment with new ECGs or would like to replace several faulty ones in the segment, please use the "post installation" function.

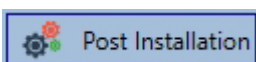

When you start the post installation in the ETS, the gateway first check if all previously configured ECGs are still available in the segment. ECGs that no longer exist or cannot be found are usually deleted from the gateway's internal memory. Should unavailable ECGs be kept (i.e. if parts of the system are not powered temporarily), the deleting can be avoided by using an additional option: "Keep already assigned ECGs"

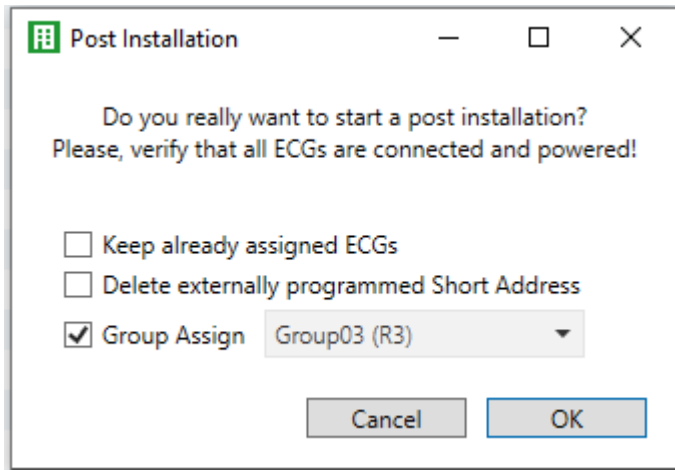

Usually ECGs have no short address and long address 0xFFFFFFFF on delivery by default. It might be possible, that ECGs got a short address even if long address is still 0xFFFFFFFF ( i.e. if an external tool was used for programming). In order to delete short address in this case please activate the control element "Delete externally programmed short address".

After verification the segment is searched for new ECGs. Newly found devices are inserted into any existing gaps or added on at the end.

**Attention:** Please remember that the maximum number of ECGs within a segment is 64.

As the position (short address) of a newly found device is allocated randomly, you need to identify the lights and if required assign them to groups.

**Note:** If you choose the setting "Switch ECG power supply via object", the corresponding objects are sent before the post installation. Afterwards the ECG can be assigned again to a group.

**Note:** It is possible to make a group selection directly during the installation, so that a time-consuming 2nd step for the assignment in groups is not necessary.

**Important:** Please remember that at this point all operations that have been performed are only displayed in the work space. They are not immediately loaded onto the DALI gateway. To start the process of downloading the settings onto the gateway and the ECGs, you must press the 'Download' button.

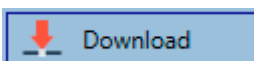

### 11.1.7 ECG Quick exchange

If you need to exchange an individual ECG because of a fault, you can also use the quick exchange function. Press the quick exchange button in the DCA.

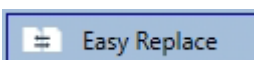

The execution of this function must be confirmed in a query window.

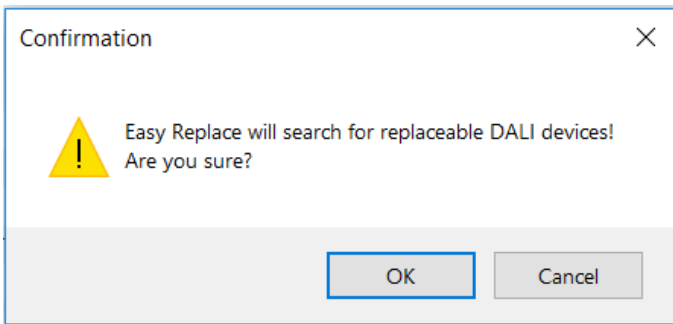

If a quick exchange is not possible because of external circumstances, the gateway terminates the process with an failure code. The different failure codes have the following meaning:

**Failure Type 7:** No ECG fault

**Failure Type 8:** More than one ECG faulty

**Failure Type 9:** No new ECG can be found

**Failure Type 10:** ECG has wrong device Type

**Failure Type 11:** More than one new ECG

### 11.1.8 Status Sync

Use this function to read and display the status of all ECGs, see chapter: [11.1.3 ECG and group detail info](#). The DALI Gateway polls the ECG status cyclically.

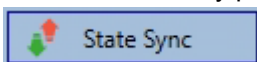

### 11.1.9 Restoring the DALI configuration

This command is used to completely restore a SpaceLogic KNX DALI Gateway Pro, for example, by replacing it with a completely unprogrammed device.

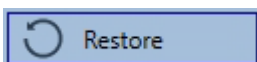

After actuation, a window appears in which the overwriting of the device configuration must be confirmed.

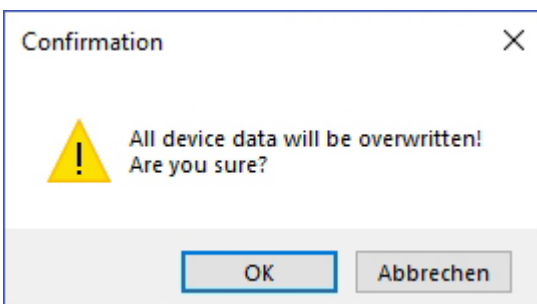

In this case all Dali relevant data from the ETS is written onto the device.

**Important:** Once this process is complete, the device must be restarted manually.

This function only applies to the DALI configuration. It is therefore essential to carry out a normal ETS download for the ETS parameters and communication objects.

**Important:** We recommend you do an ETS back-up after you have completed the configuration.

## 11.2 Website Commissioning

After the physical installation and wiring of the DALI ECGs and luminaires and the electrical commissioning, the ECG configuration must first be prepared and planned on the website. For this purpose, the commissioning page is opened:

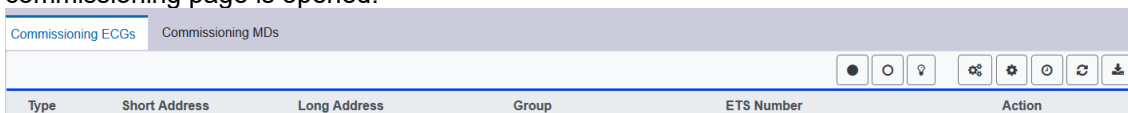

Important for commissioning via web is the correct ETS configuration of the groups and ECG settings. Here the group type (normal or colour control) and also the individual ECG types should already be correctly defined.

### 11.2.1 Preparation

The first step should be to plan and designate the ECGs and groups. For this purpose, a name (luminaire number, room number and group designation or similar) can be entered in the description field on the "Settings" page.

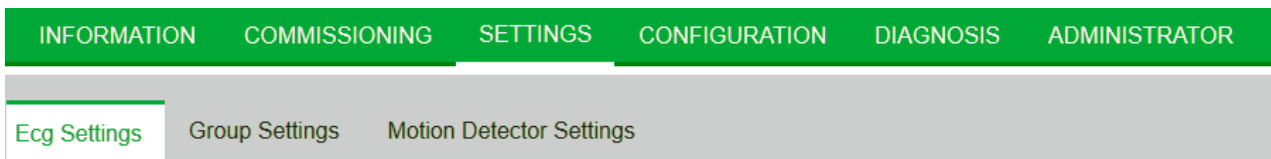

**Attention:** It is useful to assign plausible descriptive texts for the groups and for the ECGs which are to be used later as individual ECGs.

**Note:** The view under ECG settings is sorted by the ETS ECG number. These ECG numbers must then also receive the corresponding planned settings and object assignments in ETS.

Type	Number	Short Address	Group	Description	Value	Colour	Action
	1	0	Unassigned	ECG-0	0 %	N/A	

**Important:** Please note that all performed operations are initially only displayed within the user interface but are not directly loaded into the DALI Gateway. To start the save operation the save button in the upper right corner must be pressed:



## 11.2.2 New Installation

After planning, setting the parameters and linking the group addresses, the actual commissioning of the DALI segment takes place. The teach-in process of the connected DALI segment can then be started via the "Commissioning" page and the "New installation" button.

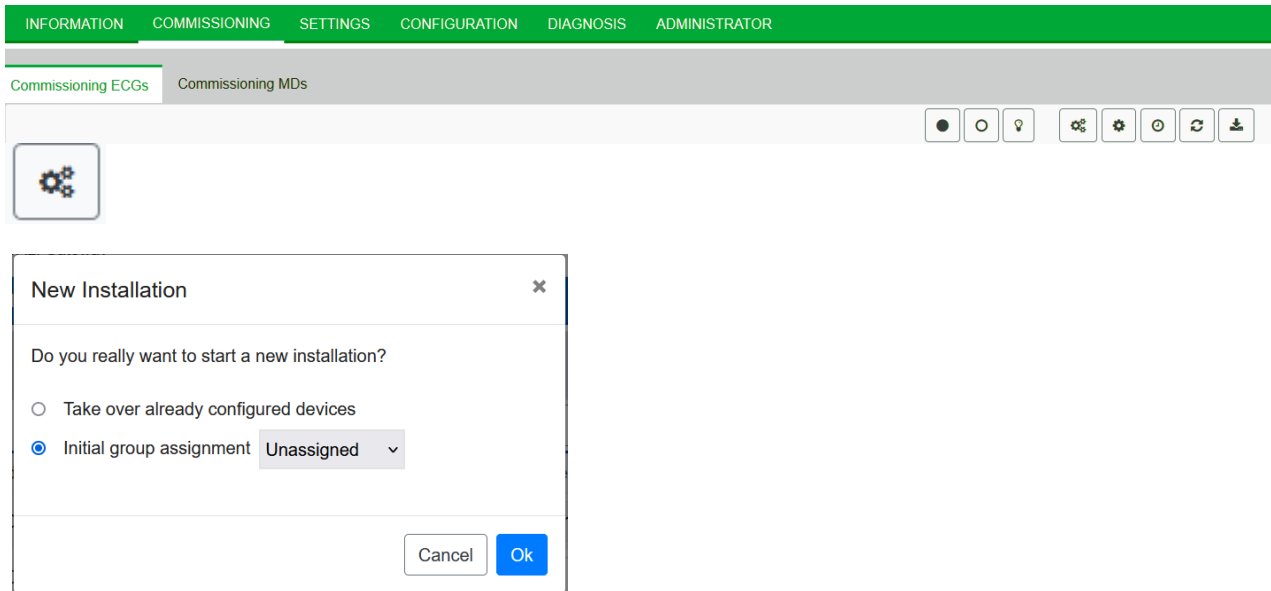

### Initial group assignment

**Note:** It is possible to make a group selection directly during the new installation, so that a time-consuming 2nd step for the assignment in groups is not necessary.

### Take over already configured devices

**Note:** Alternatively, it is possible to take over and read in an already externally configured system, i.e. ECGs and group assignment already programmed with a short address.

**Attention:** It must be taken into account that with this option the corresponding ETS number is assigned to each short address, i.e. short address 0 is assigned to ETS index 1.

Example: 2 found ECGs with short address 5 and 6 are assigned to ETS index 6 and 7.

During teach-in, all ECGs are automatically detected and each ECG is assigned a short address from 0..63. The teach-in process can take up to 3 minutes, depending on the size of the connected DALI segment. The progress is shown in the popup window.

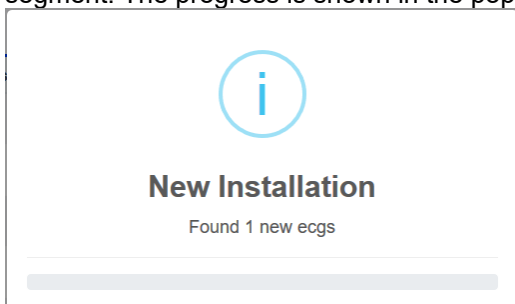

After completion of the teach-in process, all found ECGs are included in the table.

Type	Short Address	Long Address	Group	ETS Number	Action
	0	0x118DE0	Unassigned	[1]: ECG-0	
	1	0x5F2330	Unassigned	[2]: ECG-1	
	2	0xA0E939	Unassigned	[3]: ECG-2	
	3	0xE91EBF	Unassigned	[4]: ECG-3	
	4	0xE91EC0	Unassigned	[5]: ECG-4	
	5	0xE91EC1	Unassigned	[6]: ECG-5	
	6	0xE91EC2	Unassigned	[7]: ECG-6	

The identification is now carried out by switching the respective light on and off.

Once an ECG has been identified, it can be assigned as an individual ECG or to a group in the drop-down menu:

Long Address	Group	ETS Number
0x118DE0	Unassigned	[1]: ECG-0
0x5F2330	[1]: TC	[2]: ECG-1
0xA0E939	[2]: RGB	[3]: ECG-2
0xE91EBF	[3]: TC+RGB	[4]: ECG-3
0xE91EC0	[4]: Group-4	[5]: ECG-4
0xE91EC1	[5]: Group-5	[6]: ECG-5
0xE91EC2	[6]: Group-6	[7]: ECG-6
	[7]: Group-7	
	[8]: Group-8	
	[9]: Group-9	
	[10]: Group-10	
	[11]: Group-11	
	[12]: Group-12	
	[13]: Group-13	
	[14]: Group-14	
	[15]: Group-15	
	[16]: Group-16	
	Single	
	Unassigned	

The desired assignment to the ETS ECG number can then be selected.

Example: ECG with control of colour temperature with short address 1 is assigned to group 1 (TC) and ETS ECG number 2:

	1	0x5F2330	[1]: TC	[2]: ECG-1	
--	---	----------	---------	------------	--

With this procedure all found ECGs can be assigned.

**Note:** Please note that the real short address is between 0 and 63.

**Important:** Please remember that at this point all operations that have been performed are only displayed in the work space. They are not immediately loaded onto the DALI gateway. To start the process of downloading the settings onto the gateway and the ECGs, you must press the 'Download' button.



The programming process can take up to 1 minute.

**Important:** It is important to note that the programming process on the "commissioning side" only programs the DALI configuration data in gateway and ECGs. In addition, the actual ETS application with the parameter settings and group addresses must be loaded into the device before or after the DALI identification and commissioning. This is done as usual via the normal loading process in the ETS.

### 11.2.3 Post Installation

If an already commissioned DALI segment is to be extended by additional ECGs, or if several defective ECGs in the segment are to be replaced, the "post installation" function must be used.



When you start the post installation in the ETS, the gateway first check if all previously configured ECGs are still available in the segment. ECGs that no longer exist or cannot be found are usually deleted from the gateway's internal memory. Should unavailable ECGs be kept (i.e. if parts of the system are not powered temporarily), the deleting can be avoided by using an additional option: "*Keep already configured ECGs*"

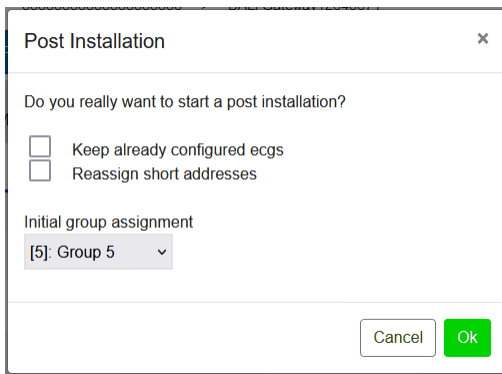

Usually ECGs have no short address and long address 0xFFFFFFFF on delivery by default. It might be possible, that ECGs got a short address even if long address is still 0xFFFFFFFF ( i.e. if an external tool was used for programming). In order to delete short address in this case please activate the control element "*Reassign short address*".

After verification the segment is searched for new ECGs. Newly found devices are inserted into any existing gaps or added on at the end.

**Attention:** Please remember that the maximum number of ECGs within a segment is 64.

Since the position (short address) of the newly found devices was assigned randomly, an identification of the luminaires and, if necessary, a group assignment must be carried out after the subsequent installation, as with the new installation.

**Note:** If you choose the setting "Switch ECG power supply via object", the corresponding objects are sent before the post installation.

Afterwards the ECG can be assigned again to a group.

**Note:** It is possible to make a group selection directly during the post installation, so that a time-consuming 2nd step for the assignment in groups is not necessary.

## 11.2.4 Failure and status display

The identification of the luminaires/ECGs during commissioning is carried out visually (switch on, switch off, flashing) and is therefore only possible if the lamps and ECGs are working without errors. If a lamp or ECG fault is identified by the gateway during the installation process, the corresponding ECG is highlighted in red.

Type	Number	Short Address	Group	Description	Value	Colour	Action
	1	4	Single	ECG No. 1	0 %	0 X 0 Y	
	2	6	[1]: Group 1	ECG No. 2	N/A %	N/A	
	3	0	Single	ECG No. 3	0 %	N/A	

**Note:** If the lifetime of a lamp, provided that a limit has been set in the ETS parameters, exceeds the value, the ECG will be highlighted in blue.

	1	4	Single
	2	6	Single

By pressing the Info button detailed information will be shown:

Show Details		Information
Long Address	0x6E1853	
Short Address	4	
Type	8	
Sub-Type	RGB SW	
Operating hours	275	
Lifetime		
Fault-State	0	

The displayed value for the fault state has the following meaning:

Value 0 (no bit set):	No error
Value 1 (bit 0 set):	Lamp error
Value 2 (bit 1 set):	ECG error
Value 4 (bit 2 set):	Converter error (only with DT-1 units for emergency luminaires)
Value 8 (bit 3 set):	Lifetime exceeded

In combination with Lifetime exceeded, a "double error" can also occur, e.g. Lifetime exceeded + lamp error =  $0x1001$  = value 9.

## 11.2.5 Operating DALI devices

The DALI devices can be controlled directly in various ways.

In the menu bar is available:

- **Broadcast :**



In this case telegrams that all participating devices react to are sent to the DALI bus.

The commands are executed by all ECGs even if they have not yet been commissioned. Therefore these commands work independently of the status of the DALI system.

- **Emergency (Converter) inhibit**



Use the context menu in the group tree on the left-hand side to disable converters.

If the power supply for the connected emergency lights is turned off within 15 minutes after activating the converter inhibit mode, the lights are turned off instead of changing into emergency mode. This operating mode may be necessary during the commissioning and installation process to prevent constant emergency lighting and battery discharge.

- **Easy Replace**



If you need to exchange an individual ECG because of a fault, you can also use the quick exchange function. This action must be confirmed by the operator:

If a quick exchange is not possible because of external circumstances, the gateway terminates the process with an failure code. The different failure codes have the following meaning:

**Failure Type 7:** No ECG fault

**Failure Type 8:** More than one ECG faulty

**Failure Type 9:** No new ECG can be found

**Failure Type 10:** ECG has wrong device Type

**Failure Type 11:** More than one new ECG

In the table for each individual ECG:

- **ECG Control:**



Single ECGs can be controlled directly.



This can be used to completely delete an ECG. After this action, it is no longer present and can only be found by renewed post installation. Therefore, this action must be confirmed by the operator.

## 11.2.6 Group/ECG Assignment

With the help of this table, ECGs can be easily assigned to groups or reassigned. Alternatively, ECGs can also be defined as individual ECGs.

This page shows the groups on the left side and the ECGs on the right side.

INFORMATION COMMISSIONING SETTINGS CONFIGURATION DIAGNOSIS ADMINISTRATOR									
Commissioning ECGs		Group/Ecg Assign		Commissioning MDs					
RGBW 1	House RGB 2	1 House left 2	2 RGBW 1	3 House right *	4 TC *	5 ECG-5	6 ECG-6	7 ECG-7	8 ECG-8
TC 3	Group-4 4	9 ECG-9	10 ECG-10	11 ECG-11	12 ECG-12	13 ECG-13	14 ECG-14	15 ECG-15	16 ECG-16
Group-5 5	Group-6 6	17 ECG-17	18 ECG-18	19 ECG-19	20 ECG-20	21 ECG-21	22 ECG-22	23 ECG-23	24 ECG-24
Group-7 7	Group-8 8	25 ECG-25	26 ECG-26	27 ECG-27	28 ECG-28	29 ECG-29	30 ECG-30	31 ECG-31	32 ECG-32
Group-9 9	Group-10 10	33 ECG-33	34 ECG-34	35 ECG-35	36 ECG-36	37 ECG-37	38 ECG-38	39 ECG-39	40 ECG-40
Group-11 11	Group-12 12	41 ECG-41	42 ECG-42	43 ECG-43	44 ECG-44	45 ECG-45	46 ECG-46	47 ECG-47	48 ECG-48
Group-13 13	Group-14 14	49 ECG-49	50 ECG-50	51 ECG-51	52 ECG-52	53 ECG-53	54 ECG-54	55 ECG-55	56 ECG-56
Group-15 15	Group-16 16	57 ECG-57	58 ECG-58	59 ECG-59	60 ECG-60	61 ECG-61	62 ECG-62	63 ECG-63	64 ECG-64

Each group is numerically and color coded and contains the respective group name. Each ECG shows the ECG number and also the respective name. In addition, the ECGs show the group memberships by a numerical and color tag. ECGs marked with an asterisk are Single ECGs. Groups and ECGs that are switched on are displayed with a yellow background.

The following functions are available in the menu line



- Group Assign Command:



This is used to assign one or more ECGs to a group. First the group must be selected, then the ECGs that are to be assigned to it. The assignment happens immediately and is confirmed by a popup. Assigned ECGs get a numeric and colored tag.

- Single-ECG:



With this command the assignment of an ECG to a group is solved. It is again a single ECG which is marked by an asterisk.

- All On/Off:



These broadcast commands switch all groups and ECGs on or off.

- Switch On/Off:



With the help of these two commands, individual groups or ECGs can be switched On or Off.

## 12 DALI Commissioning Input Devices

The SpaceLogic KNX DALI Gateway Pro allows the configuration of input devices.

**Note:** Only input devices that comply with the IEC 62386 part 301/302/303/304 standard are supported.

Each input device is identified by a short address, as with ECGs. This address is assigned during the new installation.

The SpaceLogic KNX DALI Gateway Pro supports up to 8 motion sensors and 8 push button.

Each input device can contain one or more instances. With motion sensors it is common that at least one instance represents the "motion" and at least one other instance represents the "brightness".

The exact function of the respective instances is not specified and can be found in the specification of the respective input device.

### 12.1 DCA Commissioning

The assignment settings and programming of input devices can be done in the DCA. For this purpose, switch from the "Commissioning" page to the "Input Device" page.

Type	Flag	Description	Addr	Instance No.
------	------	-------------	------	--------------

## 12.1.1 Preparation

The first step should be the complete ETS configuration and naming. Refer to chapter [20.5 Motion/Brightness Detector](#) and the following.

Depending on the ETS parameter the different types of input devices are being displayed with different icons.



Icon for Motion Detector with Brightness



Icon for Motion Detector without Brightness, according to Part 303



Icon for Brightness, according to Part 304



Icon for temperature measurement



Icon for humidity measurement



Icon for CO2 measurement



Icon for VOC measurement



Icon for Sound measurement



Icon for generic measurement, depending on input device type



Icon for push button interface, according to Part 301



Icon for absolute input, according to Part 302



Icon for push button left button



Icon for push button right button



Icon for power



Icon for energy



Icon for unknown instance type



Icon for generic input

## 12.1.2 New Installation

The teach-in process of the connected DALI segment can be started via the "Input Devices" page and the "New installation" button.

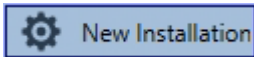

During teach-in, all input devices are automatically detected and each device is assigned a short address from 0..63. The teach-in process can take up to 3 minutes, depending on the size of the connected DALI segment. The progress is shown in the progress bar at the bottom right of the window. At the same time a display informs about the number of motion detectors found so far, or about the current process.

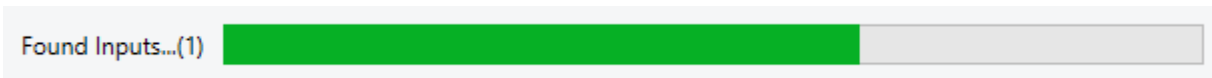

When the teach-in process is complete, all input devices found are entered in the list of devices still to be identified on the right-hand side of DCA.

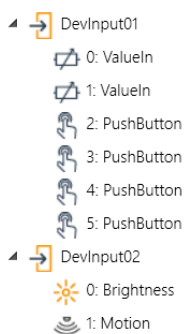

The following instance types can be recognized:



Icon for push button interface, according to Part 301 (instance type number 1)



Icon for absolute input, according to Part 302 (instance type number 2)



Icon for Motion Detector, according to Part 303 (instance type number 3)



Icon for Brightness, according to Part 304 (instance type number 4)



Icon for generic input (instance type number 0)



Icon for unknown instance type

The identification is now carried out by an identity process of the input device. When activated, one LED usually flashes in the identified device.

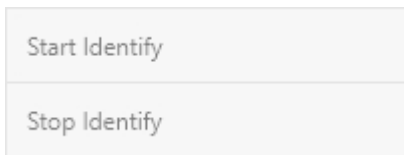

**Note:** The way in which the connected input device displays its identification may be different for different manufacturers. Please read the manufacturer's instructions.

### 12.1.3 Assignment of input devices to ETS Items

Once a device has been identified, it can be dragged and dropped to the corresponding ETS entry in the table. The assignment is based on instance level. Each instance can be assigned to the required ETS item entry.

Once the assignment via drag&drop has been done, the status is indicated by the Flag „Plan“ and the link on the right hand side is shown in normal font size.



To delete an assignment, this entry can also be dragged back into the right-hand tree.

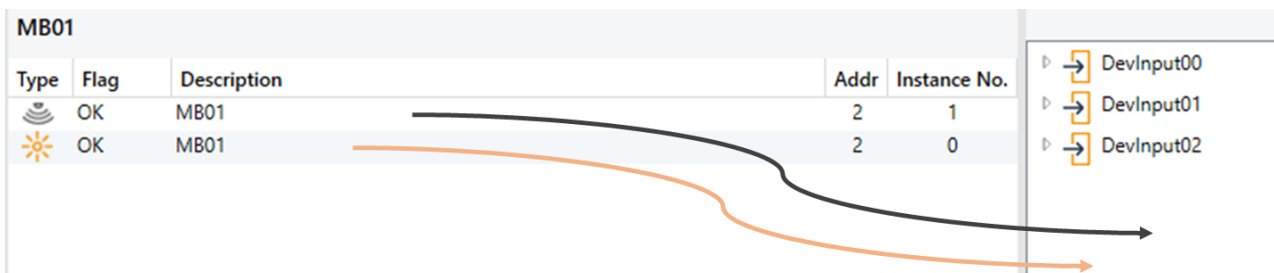

To delete all assignments of the instances of an input device, the item "Unlink All Input Items" can be found in the context menu of the device. The context menu of the input device is opened by pressing the right mouse button.

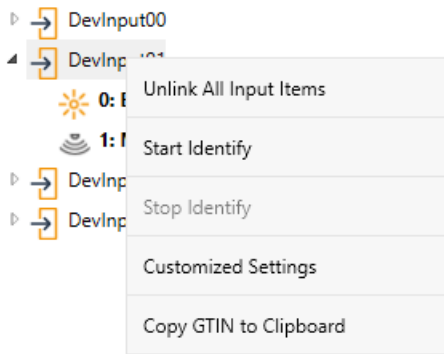

**Important:** Please note that all performed operations are initially only displayed within the user interface but are not directly loaded into the DALI Gateway. To start the loading process of the settings into the Gateway and the input devices, it is absolutely necessary to press the "Download" button.

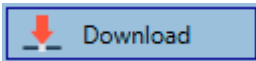

The programming process can take up to 1 minute. The progress bar provides information about the current status. When the loading process is complete, all previously planned input devices in the real system have been programmed with the DALI configuration. In the input device configuration table, the corresponding devices are marked with the "OK" flag and the link on the right hand side is shown in bold font size.

MB01				
Type	Flag	Description	Addr	Instance No.
	OK	MB01	2	1
	OK	MB01	2	0

- ▶ DevInput00
- ▶ DevInput01
- ▶ DevInput02
- 0: Brightness --> MB01
- 1: Motion --> MB01

**Important:** It is important to note that the programming process on the "commissioning side" and "Input devices side" only programs the DALI configuration data into the gateway and into the ECGs/Input sensors. In addition, the actual ETS application with the parameter settings and group addresses of the communication objects must be loaded into the device before or after the DALI identification and commissioning. This is done as usual via the normal loading process in the ETS.

### 12.1.4 Post Installation

If an already commissioned DALI segment is to be extended by additional input devices, or if one or more defective devices in the segment are to be replaced, the "Post installation" function must be used.

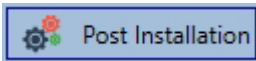

If a subsequent installation is started, the gateway first checks on the basis of the DALI long address whether all previously configured input sensors are still present in the segment. Normally input sensors that are no longer present or cannot be found are deleted from the internal memory of the gateway during the subsequent installation.

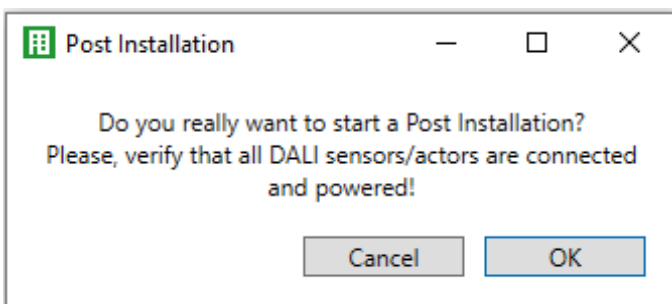

**Attention:** Please note the maximum number of 8 motion detectors and 8 push buttons in one segment.

Since the position (short address) of the newly found devices was assigned randomly, the input devices must be identified after the subsequent installation in the same way as for the new installation.

**Important:** Please note that all performed operations are initially only displayed within the user interface but are not directly loaded into the DALI Gateway. To start the loading process of the settings into the Gateway and the input devices, it is absolutely necessary to press the "Download" button.

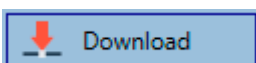

## 12.1.5 Using more than 1 Instance

The new concept allows to configure one ETS item (Motion/Brightness or Push Button) with more than one instance.

A well known use case is the master/slave concept in a long corridor. In such a situation more than one movement detector have to be installed and they should work together to light the corridor. In order to support more than one instance the according ETS parameter has to be set.

The screenshot shows the configuration window for a Motion detector. The left sidebar lists various ETS objects, with 'Motion' selected under the 'MB1, Long Corridor' group. The main configuration area is divided into several sections:

- General:** 'Number of Instances' is set to 3. 'Time without movement > Vacant (Off-Delay)' is set to 5 Minutes. 'Time without movement via Object (Off-Delay)' is set to 'Parameter'.
- Output:** 'Object Type for Output' is 'Switch Object'. 'Cyclic Sending' is 'only on presence detection'.
- Disable / Automatic Mode:** 'Usage of Disable Object' is 'Disable with Value 1'. 'Behaviour on Disable by Object' is 'Deactivate detection'. 'Activate Automatic Fallback to Normal Mode' is 'No'.
- Activate External Presence (Master/Slave) via Object:** Set to 'No'.

In DCA view each instance appears as a separate line in order to connect to a real device.



In this sample, 3 instances of 3 different real movement detectors are being connected to one ETS movement detector. This results in triggering the ETS movement detector whenever one of the 3 instances of the real devices detects a movement.

**Attention:** More than one instance connected to an ETS entry works as an “OR” gate. All events detected by the real devices will trigger the functionality.

## 12.1.6 DALI Push Buttons / Push Button Interfaces

The SpaceLogic KNX DALI Gateway Pro V2 supports up to 8 push buttons / push button interfaces with max. 8 keys or 4 pairs of keys.

The screenshot shows the ETS software interface. On the left, a tree view lists 'Sensors', 'Generic Inputs', and 'Push Buttons'. Under 'Push Buttons', items PB01 through PB08 are listed. PB01 is selected. On the right, a detailed view for PB01 shows a table with columns 'Type', 'Flag', and 'Description'. The table contains two rows for each of the four button types (L, R, L, R), all with a flag of '-' and a description of 'PB01'.

Type	Flag	Description
L	-	PB01
R	-	PB01
L	-	PB01
R	-	PB01
L	-	PB01
R	-	PB01
L	-	PB01
R	-	PB01

The ETS setting is working in “pairs”, thus also the view in the DCA displays the button “left” and “right” as a pair. If a 4-fold button is configured, only two pairs are visible.

The screenshot shows the ETS software interface. On the left, a table for PB01 configuration shows columns 'Type', 'Flag', 'Description', 'Addr', and 'Instance No.'. On the right, a list of device inputs is shown, including DevInput00, DevInput01, and DevInput02. Below DevInput02, a list of button configurations is shown, including '0: ValueIn --> IN02' and '1: ValueIn', followed by four 'PushButton --> PB01' entries numbered 2 through 5.

Type	Flag	Description	Addr	Instance No.
L	OK	PB01	2	2
R	OK	PB01	2	3
L	OK	PB01	2	4
R	OK	PB01	2	5

A push-button in the ETS can also be parameterised with several instances.

The screenshot shows the configuration dialog for a push button. It has a 'Description' field, a 'Number of Buttons' dropdown set to '4-fold', and a 'Number of Instances' dropdown set to '2 Instances'. A list on the left shows 'PB1', 'PB2', and 'PB3'.

For example, to realise two real Dali push-buttons in one room with the same configuration or mode of operation.

PB01				
Type	Flag	Description	Addr	Instance No.
	Plan	PB01	0	2
	Plan	PB01	1	0
	Plan	PB01	0	3
	Plan	PB01	1	1
	Plan	PB01	0	4
	Plan	PB01	1	2
	Plan	PB01	0	5
	Plan	PB01	1	3

DevInput00

- 0: ValueIn --> IN01
- 1: ValueIn
- 2: PushButton --> PB01
- 3: PushButton --> PB01
- 4: PushButton --> PB01
- 5: PushButton --> PB01

DevInput01

- 0: PushButton --> PB01
- 1: PushButton --> PB01
- 2: PushButton --> PB01
- 3: PushButton --> PB01

**Attention:** For further information refer to the handbook of the manufacturer of such in Input device. The instance number of the Dali button can only be adapted by the documentation of the manufacturer of this push button (interface).

### 12.1.7 Special Input Devices (Generic Inputs)

More and more manufacturer of DALI-2 Movement Detectors provide also different kinds of measurement:

- Brightness
- Temperature
- Humidity
- AIR quality
- .....

This information can also be assigned to ETS communication objects.

Therefore the ETS parameters of those “generic inputs” has to be defined accordingly, refer to chapter [20.6 Generic DALI Inputs](#).

Once such a device has been identified, it can be dragged and dropped to the corresponding ETS entry in the table.

IN01				
Type	Flag	Description	Addr	Instance No.
	Plan	IN01	0	0

DevInput00

- 0: ValueIn --> IN01
- 1: ValueIn
- 2: PushButton
- 3: PushButton
- 4: PushButton
- 5: PushButton

## 12.1.8 Customized Settings

On the right side of the DCA input device window, the context menu of each input device offers the possibility to make device-specific settings.

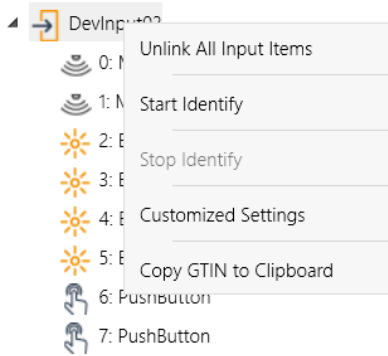

In the previous chapter Example, an absolute input instance was assigned to an ETS temperature element. Unfortunately there is no standard defined which states the format and the range of transmitted value. That results in the situation that manufacturer specific setting has to be configured in the Input device, Usually this is done by writing special value in special memory banks.

By pressing “Customized Settings” the following window will be opened:

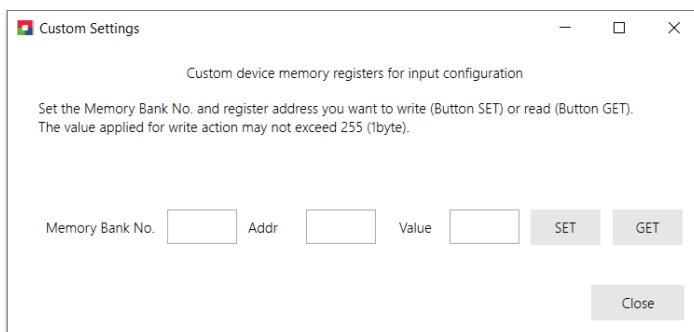

A special memory position is defined by Memory Bank Number, the memory address and the value to be written or to be read.

**Attention:** For further information refer to the manual of the manufacturer of such in Input device. Take care by any modification.

## 12.1.9 Failure and status display

During operation an input device or even a single instance can report a failure. If the gateway identifies a fault, the instance concerned is highlighted in red



As the view is not automatically updated and as it may take a few minutes for the DALI gateway to recognise a fault, we recommend that you press the 'Status Sync' button to manually trigger an update of the view.

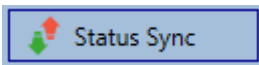

This ensures that the displayed status is updated with the actual status and any failures that may have been detected in the meantime are displayed correctly.

### 12.1.10 Retrieving the GTIN

Sometimes it might be very interesting to lookup some data in the official "Product Database" of the DALI Alliance, refer to <https://www.dali-alliance.org/products>. A simple reference to find a product is the GTIN number, which is unique for each DALI-2 device.

On the right hand side of the DCA commissioning window, the context menu of each input device provides the possibility to copy the GTIN to the clipboard.

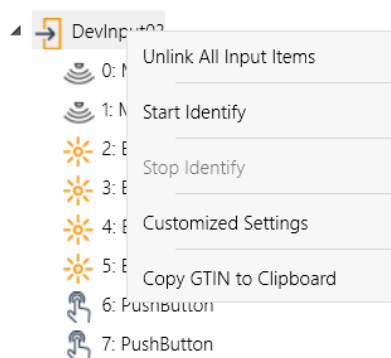

This information can in a next step easily be used in the product database webpage

### 12.1.11 Website Commissioning

Due to the strong interaction with the ETS context and parameters, commissioning of the input devices using the website is not supported.

## 13 The scene module

The SpaceLogic KNX DALI Gateway Pro enables the programming and invoking of up to 16 internal light scenes. A scene is invoked via a 1Byte scene object. It can be adjusted by which KNX scene 1..64 (value 0..63) which of the 1..16 DALI scenes is invoked. This object can also be used to save scenes (Bit 7 set). The currently set value is saved as scene value. In case of DALI DT-8 devices, the currently set light colour or colour temperature also becomes part of the scene and is automatically adjusted when a scene is invoked.

General, a scene can consist of groups and individual ECGs (as long as these have not been assigned to a group).

To assign a group to a scene or to delete a group from a scene and to assign the KNX scene number to the DALI scene, use the DCA or the website. Both configuration methods can be used to set values and colours for invoking a scene.

By default, when a scene is called up, the programmed scene is jumped to immediately without dimming time. If a scene is to be dimmed, a dimming time can also be set for each scene. If a scene is in the process of dimming, switching an individual group (or an ECG) from the scene does not cause the entire scene to be stopped, but only the group addressed is affected. All other groups continue the dimming process started by the scene call.

For each scene a 4 Bit dim object is available. This makes it possible to dim all the lights in a scene together.

### 13.1 Scene configuration via DCA

Scenes can be programmed and assigned in the DCA. For this purpose change from the commissioning to the scene page.

Item	Value	Colour	Keep Value	Keep Colour
Group01 (Building 1, Level 0, Room 01)	20%	R: 255 ; G: 0 ; B: 0	<input type="checkbox"/>	<input checked="" type="checkbox"/>
Group02 (Building 1, Level 0, Room 02)	50%	CT: 3000°K	<input type="checkbox"/>	<input type="checkbox"/>
Group03 (Building 1, Level 0, Room 03)	100%	R: 108 ; G: 136 ; B: 255 ; W: 0	<input type="checkbox"/>	<input type="checkbox"/>

#### 13.1.1 Configuration

You can enter a user-friendly name for each scene in the description field. The name can be up to 20 characters long.

Scene 1 (20) ✓ Description Meeting Room B1, LO Fade Time 1s KNX Scene 20

If you do not want a scene to start immediately but would prefer dimming it up to its final value, you can set the dimming time individually for each scene.

Please remember that the dim time always refers to the full value range. Accordingly a dim time of 30 s means a value change of 100% within 30 s. If the value within a scene is only changed by 50%, the change is performed within 15 s.

Select the required scene from the dropdown on the left-hand side.

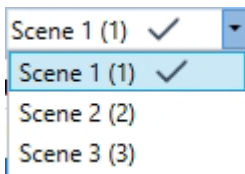

A "tick" means that the scene has already been defined.

A scene is activated by a 1 Byte scene object according DPT 18.001. In the KNX standard you are able to address up to 64 scenes by this datapoint. In the DALI gateway there are only 16 scenes available. By default DALI scenes are assigned one to one to the KNX scenes, what means scene 1 of the DALI gateway is usually invoked by object value 0 (KNX scene 1) respectively by object value 128 it is programmed. In the DCA it is now possible to change this assignment. This adjustment can be done in the headline of the scene editor.

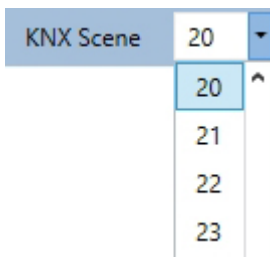

In the example above, the selected DALI scene can be invoked object value 19 (KNX scene 20), respectively programmed by value 147. Please note that the assignment has to be unique. If different DALI scenes are assigned to the same KNX scene only the first DALI scene is activated / programmed.

The groups which you would like to use for this scene can be moved from the tree on the right-hand side into the field in the middle using drag-and-drop.

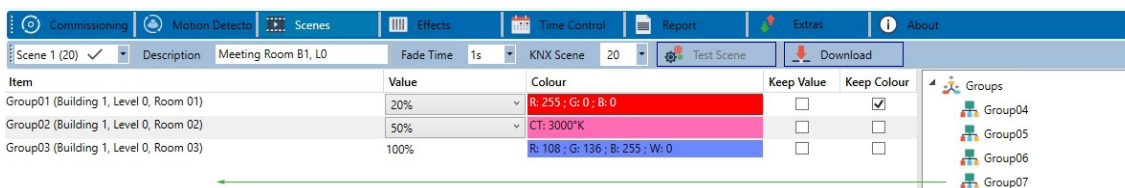

Use the entry fields to enter the required values for this scene.

- **Value**

A brightness level between 0 and 100% can be selected via a drop down field.

- **Colour**

Defines the colour according to Type of colour control for this group. Use the context menu or simply double-click to open a window to select the colour from a colour picker.

- **Keep value**

In this case the current value remains unchanged when the scene is invoked. The entry field for the value is disabled. Any entry in the value field is ignored.

- **Keep colour**

In this case the current colour remains unchanged when the scene is invoked. The entry field for the colour is disabled. Any entry in the colour field is ignored.

To delete an entry, select a group and use drag and drop to move it back to the tree on the right-hand side.

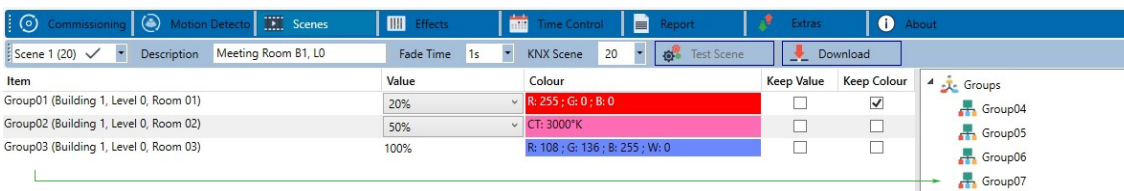

You can also delete an entry via the context menu (right click on a line):

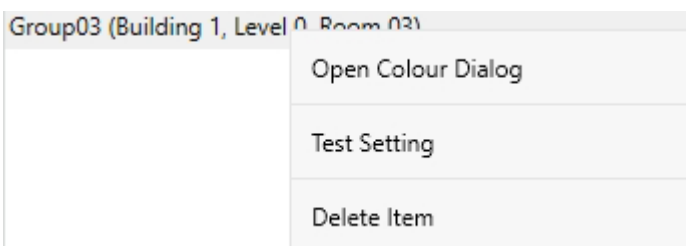

### 13.1.2 Colour setting

Each group or ECG can only support one Type of colour control.

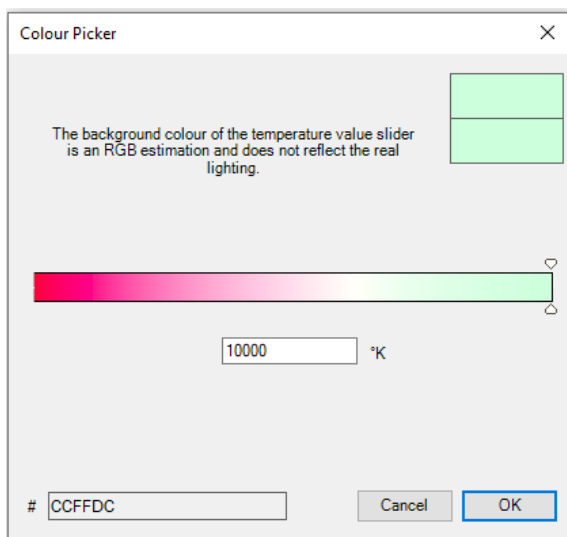

The following color input window is displayed for the "Color Temperature" type.

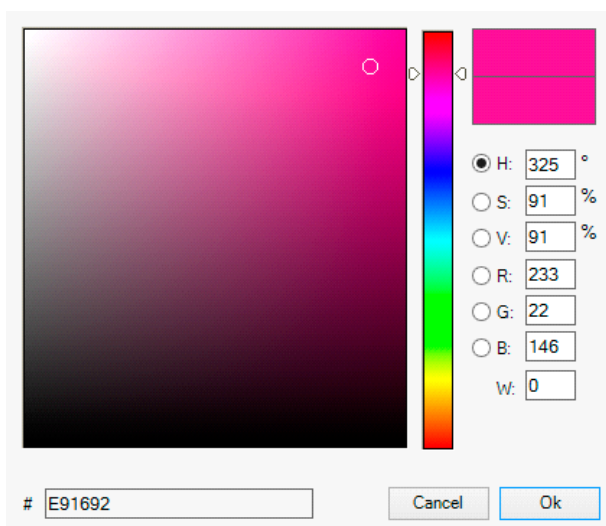

For the "RGB (RGBW)" or "HSV" type, this color input window is displayed.

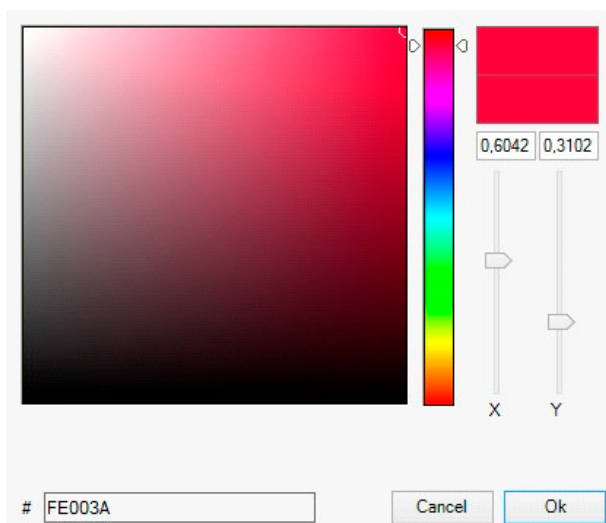

For the type "XY" this color input window is displayed.

### 13.1.2.1 Groups with flexible Colour Control Types

If a group in ETS is selected as color type "RGB + color temperature", this group can be used in the scene with both color controls. This type is indicated by the following dialog element:

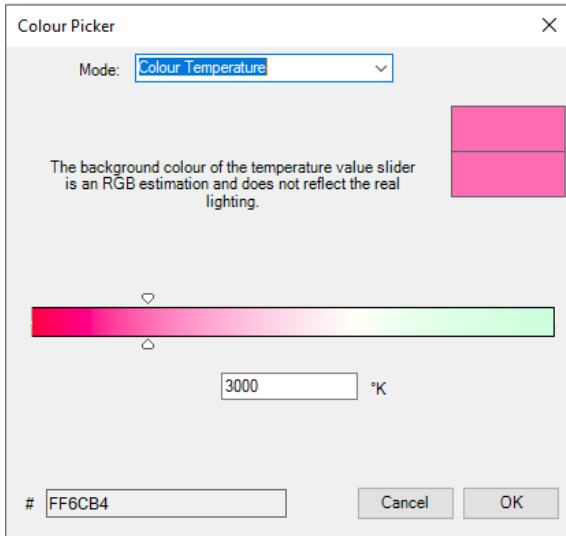

In the upper setting the type of control can be selected.

### 13.1.3 Programming scenes

Once all scene values have been set and assigned, you need to download the scene onto the DALI ECGs. For this purpose, please press the download button in the top right-hand corner.

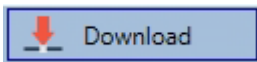

A connection to the SpaceLogic KNX DALI Gateway Pro is required. In principle, you can also plan individual scenes in the ETS 'offline', independently of the DALI system. The DCA only has to be connected to the gateway for the duration of the programming.

### 13.1.4 Testing a scene event

One way to test the settings for an event is via the context menu (right click with the mouse).

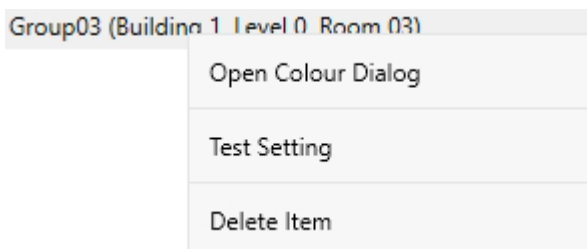

A connection to the SpaceLogic KNX DALI Gateway Pro is required. The command setting the value and colour of the group is executed. This means you can check the correct properties before programming the whole scene. If "Keep Value" or "Keep colour" have been selected, the current values are kept and the new values are not activated.

### 13.1.5 Testing the scene as a whole

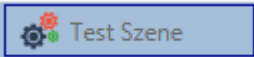

After a scene has been programmed, the button becomes active. Press the button to activate and execute the selected scene. A connection to the SpaceLogic KNX DALI Gateway Pro is required for this purpose.

### 13.1.6 Export/Import/Delete

In order to be able to reuse a scene that has already been created, it is possible to export it. The created XML file can be saved separately to be used again in another project or in another template. The commands for export or import can be found in the context menu.

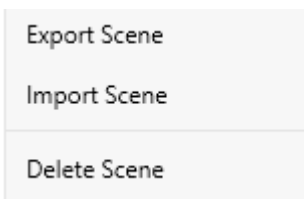

The template is saved as an XLM file in the desired target directory

## 13.2 Scene configuration via web server

The assignment settings and programming of scenes can be done from the web page via the web server. After starting the web page, switch to the configuration page for this purpose and select "Scenes".

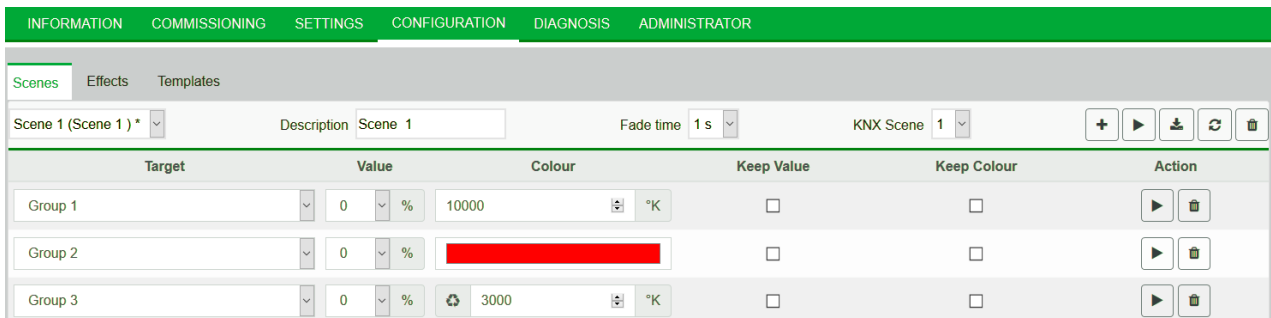

Up to 16 scenes can be configured here. Each scene can be provided with a description text.

### 13.2.1 Configuration

On the left side, the desired scene can be selected in the drop-down menu. An "asterisk" indicates that this scene has already been defined.

In the description field of the scenes a user friendly name can be assigned. This name can be up to 10 characters long.

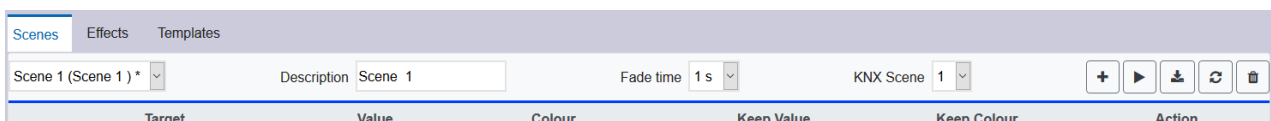

If the scene is not to be jumped to immediately when called up, but is to be dimmed to the end value, a dimming time can also be set individually for each scene.

Please note that the dimming time always refers to the complete value range. Accordingly, a dimming time of 30 s means a change in value of 100% within 30 s. If the value is only changed by 50% within the scene, this change will be made within 15 s.

The scene is activated via a 1-byte scene object in accordance with DPT 18.001. In the KNX standard, up to 64 scenes can be addressed. However, only 16 scenes are available in the DALI Gateway. By default, the assignment of the DALI scene to the KNX value which calls up the scenes is set to 1 to 1 assignment. This means that scene 1 of the DALI gateway is activated via the KNX object value 0 (KNX scene 1), or programmed via the object value 128. It is possible to change this assignment. The setting can be made in the header of the scene editor:

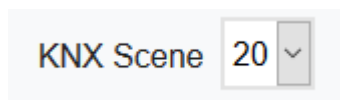

In the example above, the selected DALI scene is then called up via the object value 19 (KNX scene 20) or programmed via the value 147. It must be ensured that the assignment is unique. If the same KNX scene is assigned to different DALI scenes, only the first DALI scene is retrieved / programmed by the KNX scene call.

The following actions are available for a selected scene:

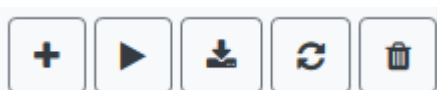

- Adding a new entry
- Test this scene (the scene must first be loaded into the gateway)
- Saving the scene
- Reload configuration data
- Deleting a Scene

## 13.2.2 Colour Settings

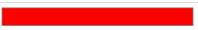

If individual ECGs or groups are parameterised for colour control (DT-8), a colour can be set in addition to the light value. To do this, click in the Color field of the desired ECG or group:

Target	Value	Colour	Keep Value	Keep Colour	Action
Group 1	0 %	10000 °K	<input type="checkbox"/>	<input type="checkbox"/>	<input type="button" value="▶"/> <input type="button" value="🗑"/>
Group 2	0 %		<input type="checkbox"/>	<input type="checkbox"/>	<input type="button" value="▶"/> <input type="button" value="🗑"/>

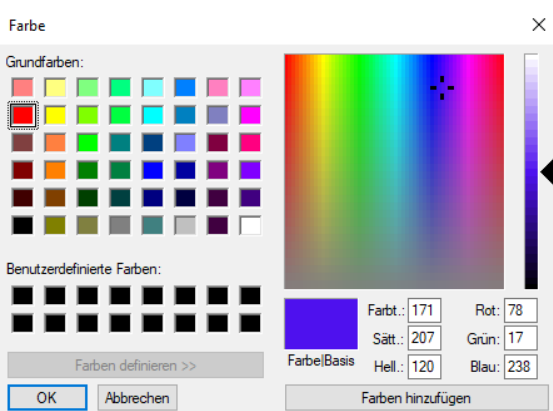
**Attention:** Setting a colour is only possible if the respective group or ECG has been enabled for colour control. Otherwise the note N/A (not applicable) appears in the "Color" field. A further window opens in which the color data can be set.

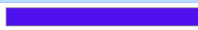

With the confirmation "OK" the set colour for the group / individual ECG is adopted in the scene.

Target	Value	Colour	Keep Value	Keep Colour	Action
Group 1	0 %	10000 °K	<input type="checkbox"/>	<input type="checkbox"/>	<input type="button" value="▶"/> <input type="button" value="🗑"/>
Group 2	0 %		<input type="checkbox"/>	<input type="checkbox"/>	<input type="button" value="▶"/> <input type="button" value="🗑"/>
Group 3	0 %	 3000 °K	<input type="checkbox"/>	<input type="checkbox"/>	<input type="button" value="▶"/> <input type="button" value="🗑"/>

Two additional flags can be used to set whether only the value setting or only the colour setting should be made:

- KV (Keep Value) Value remains as set, only colour is taken into account
- KC (Keep Colour) Colour remains as set, only value is taken into account

### 13.2.2.1 Groups with variable colour control

If a group in ETS is selected as color type "RGB + color temperature", this group can be used in the scene with both color controls.

This type is indicated by the following dialog element:



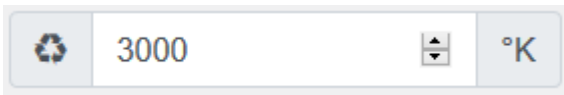

By clicking on the front icon, the input of color temperature in Kelvin changes to the normal color dialog.

### 13.2.3 Programming the scenes and scene test

Once all entries have been made for all desired scenes, the settings must be loaded from the browser into the device. This is done by pressing the "Save" button.



The scene data are then also transferred simultaneously to the connected ECGs.

During programming, a descriptive text (max. 10 characters) can also be assigned to the respective scene. To do this, the name must be entered in the text field above the scene block before saving.

If the selected scene is to be activated for testing, this can be done using the "Test scene" button.



The scene data can be loaded from the gateway into the web browser using the "Reload scene" button.



### 13.2.4 Testing an event in the scene

A way to test the setting of an event is in the "Action" column. When the "Play" button is activated, this event is sent to the DALI bus.

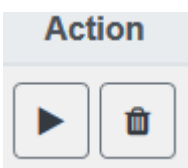

The command with the setting of the value and color is executed for this group or ECG. In this way the desired property can be checked before programming the whole scene. If the properties "Keep value" or "Keep color" are set, the corresponding values are not activated but are kept at the current value.

## 14 The effect module

In addition to light scenes the SpaceLogic KNX DALI Gateway Pro also enables the use of effects. An effect is essentially the process control of light values of different groups and individual ECGs. The individual light values can either be directly controlled or dimmed via a dim value. Please remember that the value relates to a dim time between 0 and 100% (see scene module). The SpaceLogic KNX DALI Gateway Pro enables 16 independent effects. An effect is started or stopped via a 1 Byte object. Set Bit 7 in the object to start the effect. Receiving the object with a deleted Bit 7, will stop the effect.

Altogether, 500 effect steps can be programmed, which can be spread across 16 effects.

### 14.1 Effect configuration with the DCA

Effect programming and assigning can be done via the DCA. For this purpose, please change from the commissioning to the effect page.

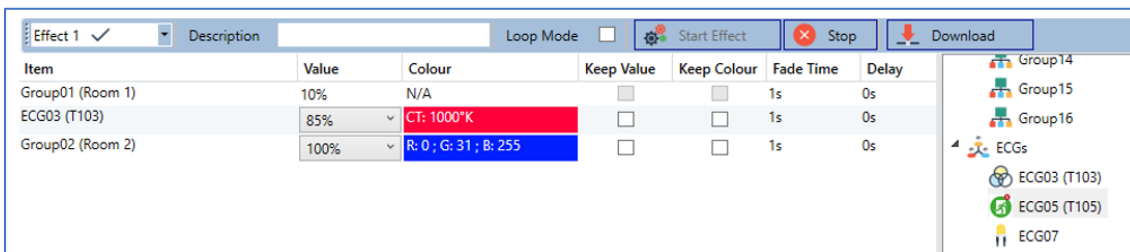

#### 14.1.1 Configuration

On the effect page, select the required effect from the drop down field.

In the description field of the effect a user friendly name can be assigned. This name can be up to 20 characters long.

If the "Loop Mode" setting is checked, this effect is played endlessly and can only be stopped by a stop command.

Drag the groups and individual ECGs that are required for this effect from the tree on the right hand side into the middle field listing the effect steps. The order of the list entries corresponds to the individual effect steps. To change the order within the list, use the mouse to move the entries around.



Enter the values required for the scene in the different fields.

### Value

Defines the light value between 0 and 100%. The value can be selected via a drop-down field.

### Colour

Defines the colour according to the Type of colour control for this group. Double-click on the mouse or use the context menu to open a window and simply select the colour from a colour picker.

### Keep value

With this setting, the current value remains unchanged when the scene is recalled. The entry field for the value is disabled with this setting as it is not needed. Any entry in the value field will be ignored.

### Keep colour

With this setting, the current colour remains unchanged when the scene is recalled. The entry field for the value is disabled with this setting as it is not needed. Any entry in the colour field will be ignored.

### Fade time

Defines the time needed to achieve the required setting. This entry can be used to define fading effects.

### Delay

Defines the time until the next event.

To delete an entry, select a group and drag it back into the tree on the right hand side.

Another option to delete an entry is via the context menu (delete element):

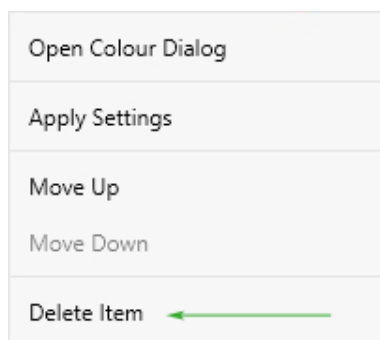

## 14.1.2 Colour settings

Each group or ECG can only support one Type of colour control.

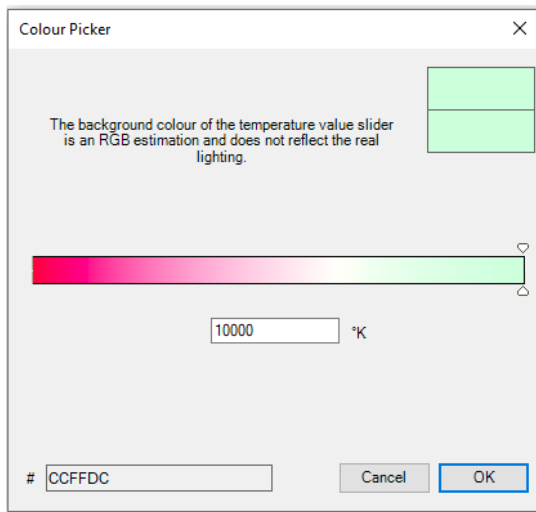

The following color input window is displayed for the "Color Temperature" type.

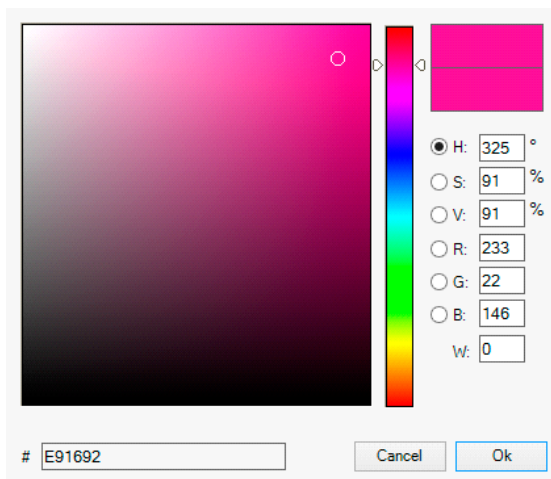

For the "RGB (RGBW)" or "HSV" type, this color input window is displayed.

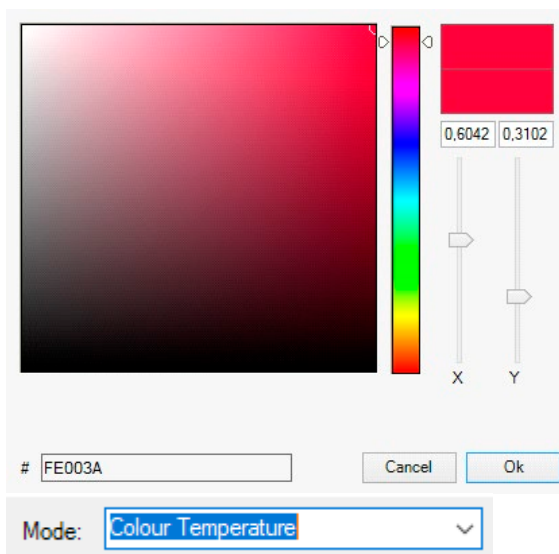

For the type "XY" this color input window is displayed.

For the type RGB + color temperature a selection option is offered in the upper line

### 14.1.3 Programming effects

Once all effect values have been set and assigned, save the effect on the device. Press the "download" button in the top right hand corner.

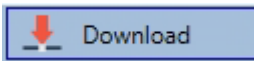

A connection to the SpaceLogic KNX DALI Gateway Pro is required for the download. Individual effects can also be planned "offline" in the ETS, independently of the DALI system. The DCA only needs to be connected to the gateway for the download.

### 14.1.4 Testing an effect event

To test the settings of an event, use the context menu (Right click on a field):

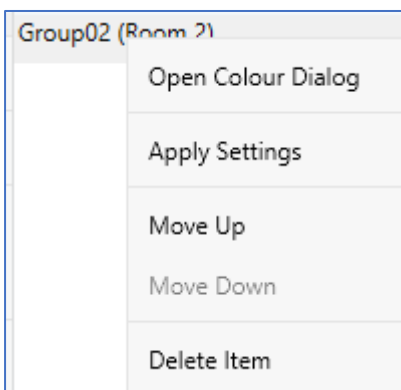

Connection to the SpaceLogic KNX DALI Gateway Pro is required. The command is performed with the value and colour settings that have been defined for this group or ECG. This makes it possible to check properties before the whole effect is programmed. If "Keep value" or "Keep colour" have been set, the respective values will not be activated and the current value will be retained.

### 14.1.5 Testing the whole effect

After an effect has been programmed, the button is activated. Press the button to start the selected effect. Connection to the SpaceLogic KNX DALI Gateway Pro is required.

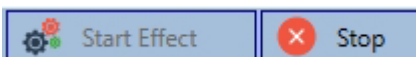

To stop an endless (loop mode) effect, press the stop button.

### 14.1.6 Export/Import/Delete

In order to be able to reuse an effect that has already been created, it is possible to export it. The created XML file can be saved separately to be used again in another project or in another template. The commands for export or import can be found in the context menu.

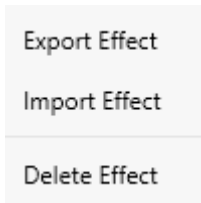

The template is saved as an XLM file in the desired target directory

## 14.2 Effect configuration via web server

The assignment settings and the programming of effects can be done from the website via the web server. After starting the web page, switch to the configuration page and select "Effects".

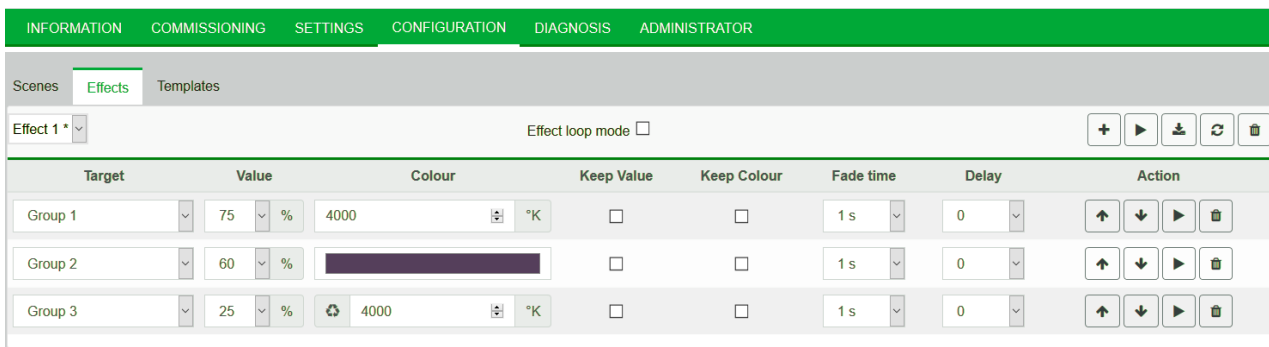

### 14.2.1 Configuration

On the left side, the desired effect can be selected in the drop-down menu. An "asterisk" indicates that this effect has already been defined.

If the "Endless" setting is checked, this effect is played endlessly and can only be stopped by a stop command.

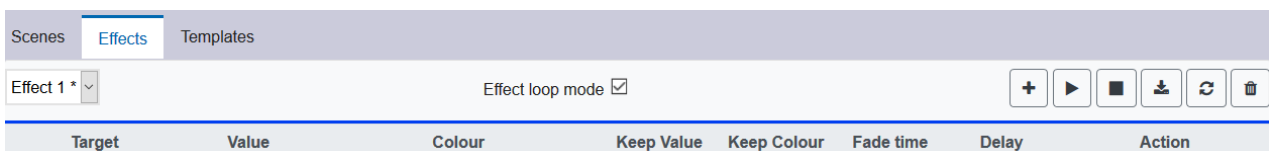

The following actions are available for a selected effect:



- Adding a new entry
- Testing the effect (the effect must first be loaded into the gateway)
- Saving the effects

- Reload configuration data
- Delete effect

Use the "Plus" button to add new entries to the selected effect.

In the DropDown Element you can now select the desired group or the desired single ECG.

The order of the entries in the list corresponds to the order of the individual effect steps. If the order within a list is to be changed, this can be changed using the buttons in the action column.



The desired values for this effect can be entered in the individual entries.

#### **Value**

Specifies the brightness value in 0..100% and can be selected via a drop-down field.

#### **Colour**

Specifies the color according to the type of color control for this group. To do this, a window is opened by clicking on it to simply select the colour in a colour picker.

#### **Keep value**

With this setting, the current value remains unchanged when the effect is called. The input field for the value is deactivated, as it is not taken into account in this function. An entry in the value field is ignored.

#### **Keep color**

With this setting, the current color remains unchanged when the effect is called. The input field for the color is deactivated, as it is not considered in this function. An entry in the color field is ignored.

#### **Fade time**

With this setting, the time can be defined to reach the desired setting.  
This allows you to define crossfade effects.

#### **Delay**

The delay defines the time until the next event is set.



#### **Delete**

To delete an entry, use the corresponding button in the action column.



## 14.2.2 Colour settings

If individual ECGs or groups are parameterised for colour control (DT-8), a colour can be set in addition to the light value. To do this, click in the Color field of the desired ECG or group:

Target	Value	Colour	Keep Value	Keep Colour	Fade time	Delay	Action
Group 1	75 %	4000 °K	<input type="checkbox"/>	<input type="checkbox"/>	1 s	0	↑ ↓ ▶ ☒
Group 2	60 %		<input type="checkbox"/>	<input type="checkbox"/>	1 s	0	↑ ↓ ▶ ☒
Group 3	25 %	 4000 °K	<input type="checkbox"/>	<input type="checkbox"/>	1 s	0	↑ ↓ ▶ ☒

**Attention:** Setting a colour is only possible if the respective group or ECG has been enabled for colour control. Otherwise the note N/A (not applicable) appears in the "Color" field. A further window opens in which the color data can be set.

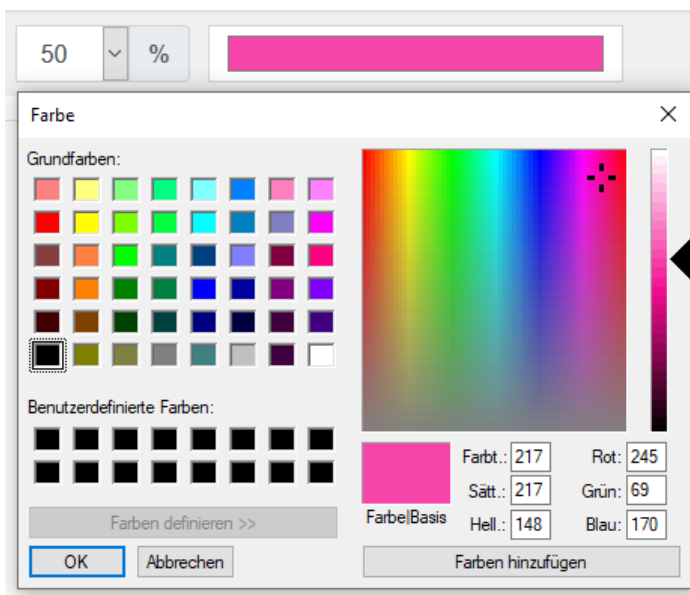

With the confirmation "OK" the set colour for the group / individual ECG is adopted in the effect.

### 14.2.2.1 Groups with variable colour control

If a group in ETS is selected as color type "RGB + color temperature", this group can be used in the effect with both color controls.

This type is indicated by the following dialog element:

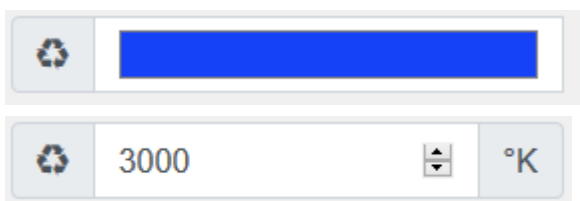

By clicking on the front icon, the input of color temperature in Kelvin changes to the normal color dialog.

### 14.2.3 Programming the effects and effect test

Once all entries for all desired effects have been made, the settings must be loaded from the browser into the device. This is done by pressing the "Save" button.



If the selected effect should be activated for testing, this can be done by pressing the "Test effect" button.



In case of loop mode the effect can be stopped.



Loading the effect data from the gateway into the web browser is possible by pressing the "Reload Effects" button.



### 14.2.4 Testing an event in an effect

A way to test the setting of an event is in the "Action" column. When the "Play" button is activated, this event is sent to the DALI bus.

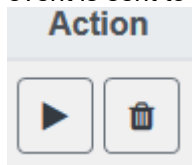

The command with the setting of the value and color is executed for this group or ECG. This way the desired property can be checked before programming the whole effect. If the properties "Keep value" or "Keep color" are set, the corresponding values are not activated but are kept at the current value.

## 15 Time control module for values and colours

In order to use the colour setting options of DT-8 devices, SpaceLogic KNX DALI Gateway Pro offers an integrated time control module. With this module, users can automatically set a defined light colour and potentially a light value depending on the current time and date. Up to 16 templates are available. A template combines different actions which will trigger an event at a configurable time.

Time control of DT-8 colour ECGS is particularly interesting for white light control. Changes in colour temperature over the course of a day have a positive effect on well-being and efficiency in the work place. Educational institutions, hospitals and many other settings use daytime dependent white light control.

The time control module can also be used to implement general temporal colour changes in DT-8 devices. For example, a building facade can be illuminated in red light in the first half of the night and in blue light in the second half of the night. Automatic adjustment of the dimming value depending on the time is also possible.

### 15.1 Time schedules configuration with DCA

Time control can be programmed and assigned in the DCA. For this purpose change from the commissioning to the time control page.

Function	Value	Hour	Minute	Fade Time	M	T	W	T	F	S	S
Colour RGB	R: 255 ; G: 0 ; B: 0	12:00		1s	<input checked="" type="checkbox"/>	<input checked="" type="checkbox"/>	<input checked="" type="checkbox"/>	<input checked="" type="checkbox"/>	<input checked="" type="checkbox"/>	<input checked="" type="checkbox"/>	<input checked="" type="checkbox"/>
Colour Temperature	CT: 4000°K	13:00		1s	<input checked="" type="checkbox"/>	<input checked="" type="checkbox"/>	<input checked="" type="checkbox"/>	<input checked="" type="checkbox"/>	<input checked="" type="checkbox"/>	<input checked="" type="checkbox"/>	<input checked="" type="checkbox"/>

#### 15.1.1 Configuration

Use the drop down on the left hand side to select a template.

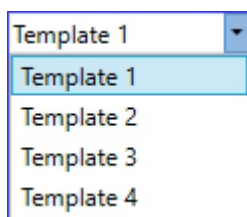

A "tick" means that the template has already been defined.

Use the description field to enter a user friendly name for the template. The name can be up to 20 characters long and is displayed in brackets in the dropdown list for information purposes.

You can also define the behaviour of the template:

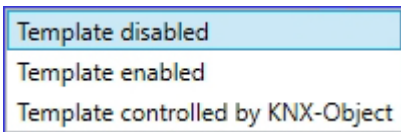

The template can be disabled. By default all templates are enabled. It is also possible to enable or disable the template via a communication object. If you choose the option "control template via object" the corresponding objects are displayed. See chapter: [19.1.4 Time control objects](#)

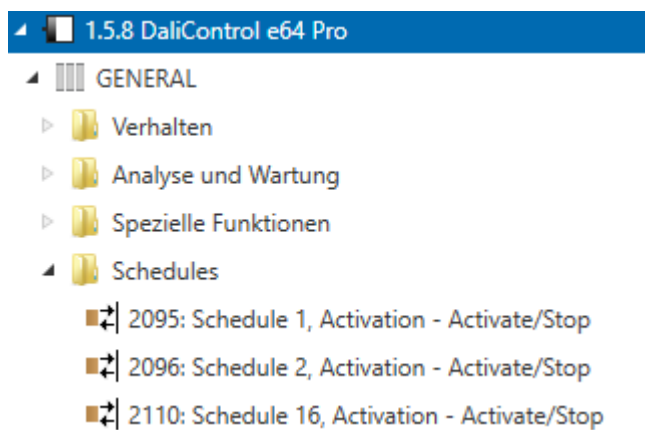

By using the „Manual Override” Option you can allow to temporally deactivate a certain group in this template. Please refer to chapter [15.1.4 Manual Override](#)

Use the tree on the right hand side to select the DALI groups that you want to include in the template.

The middle part of the page is used to create an action list. All groups that have been selected, automatically perform an action at the configured time. Altogether a maximum of 300 actions can be stored on a DALI gateway if all templates are used. A context menu is available to control and create action lists.

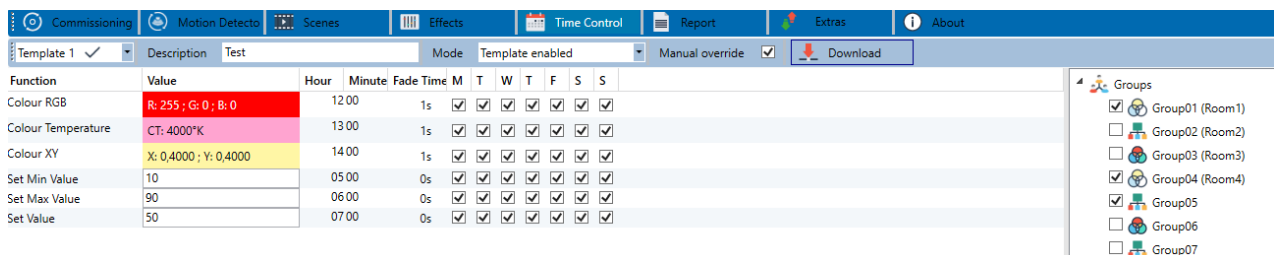



A total of 11 function types are available for time control.  
See chapter: [15.1.2Types of action](#)

The creation of action lists and the operation is done as far as possible via the context menu. The context menu opens when the mouse pointer is positioned on an action in a line and the right mouse button is pressed. The following functions are then available for editing and creating action lists:

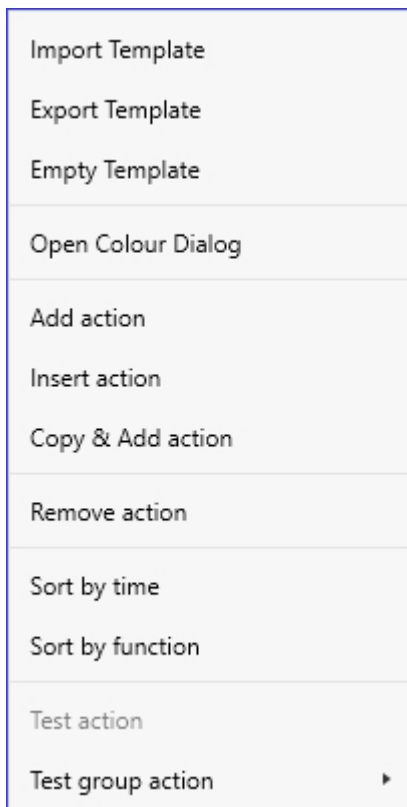

**Import template**

see [15.1.5 Export/Import](#)

**Export template**

see [15.1.5 Export/Import](#)

**Empty template**

Completely removes the configuration of this template.

**Add action**

Creates a new action and adds it to the end of the list.

**Insert action**

Creates a new action and inserts it between two existing list entries.

**Copy and add action**

Copies a selected action and adds it to the end of the list.

**Delete action**

Deletes a selected action.

**Sort by time**

Sorts the action list into ascending chronological order.

### **Sort by function**

Sorts the action list according to function entries.

### **Test action**

Immediately executes the chosen action (without regard for any potentially configured transition time) for all selected groups within a template. A connection to the SpaceLogic KNX DALI Gateway Pro is required.

### **Test group action**

Immediately executes the chosen action (without regard for any potentially configured transition time) for a selected group within a template. You can also select the group via the context menu. A connection to the SpaceLogic KNX DALI Gateway Pro is required.

## **15.1.2 Types of action**

Once you have created an action, set the corresponding function via the selection box. For each function, you can select a value, the time of the action and (if you would like the value to slowly cross-fade) a transition time. If you do not want the action to be performed every day, please enter the days of the week when you want to schedule the action. Please remember that only certain value ranges make sense for each function. In principle any value can be entered in the value field. However, if this value exceeds the possible value range, it is automatically limited to the maximum value. (For example, if you enter 200 for the function "Set value", the maximum value 100% is automatically entered.) The following functions are possible for an action:

### **Set value**

Sets the brightness level of a group. The permitted value range is between 0 and 100%.

### **MinValue**

Sets the minimum dim value of the selected group for relative (4 Bit) and absolute (8 Bit) dimming. When using this action, any minimum dim value set in the ETS parameters is automatically overwritten. The permitted value range is between 0 and 100%.

This value is reset to the ETS setting after an ETS download.

### **MaxValue**

Sets the maximum dim value of the selected group for relative (4 Bit) and absolute (8 Bit) dimming. When using this action, any maximum dim value set in the ETS parameters is automatically overwritten. The permitted value range is between 0 and 100%.

This value is reset to the ETS setting after an ETS download.

### Colour temperature

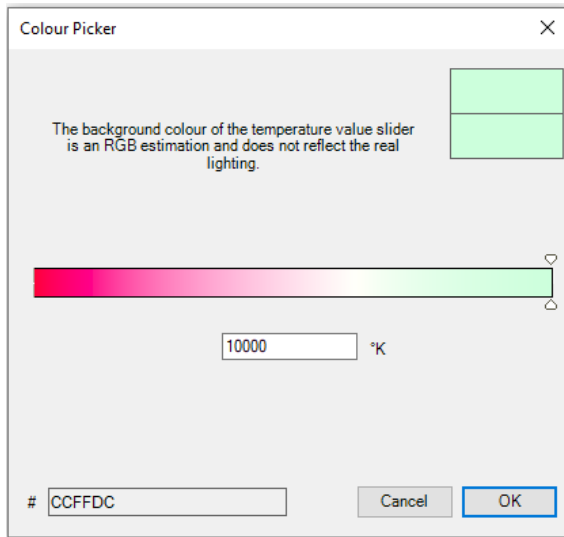

This function sets the colour temperature of DT-8 devices that support the colour temperature setting (TC). On the ECG the colour is also changed if the lamp is turned off at the time of the action. You can enter the colour temperature range. The value range permitted is between 1000 and 10000 K but please remember the physical limits of the connected ECGs and lights.

### Colour RGB

Sets the colour values of DT-8 devices that support the colours RGB. On the ECG the colour is also changed if the lamp is turned off at the time of the action. The values for each colour can be entered separately. The permitted value range for R,G and B is between 0 and 255. The final colour is a mixture of the different primary colours according to their percentage.

### Colour RGBW

Sets the colour values of DT-8 devices that support the colours RGB or RGBW.

On the ECG the colour is also changed if the lamp is turned off at the time of the action.

The values for each colour can be entered separately. The permitted value range for R,G,B and W is between 0 and 255. The final colour is a mixture of the different primary colours according to their percentage.

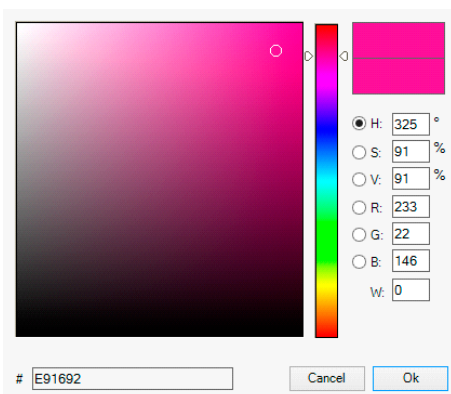

### Colour HSV

Sets the colour values of DT-8 devices that support the colours RGB.

However, the value is entered by means of saturation, hue and brightness levels in this case.

On the ECG the colour is also changed if the lamp is turned off at the time of the action.

The permitted value range for the hue is between 0 and 360°, the value range for saturation and brightness is between 0 and 100%.

### Colour HSVW

In this function, a separate white value (separate channel) is specified in addition to HSV.

### Colour XY

Sets the XY colour of DT-8 devices that support the XY colour space.

On the ECG the colour is also changed if the lamp is turned off at the time of the action. The X and Y coordinates of the colour can be entered separately. The permitted value range for X and Y is from 0.0 to 1.0. Please remember the physical limits of the connected ECGs/lights. Not every colour from the colour spectrum can be set.

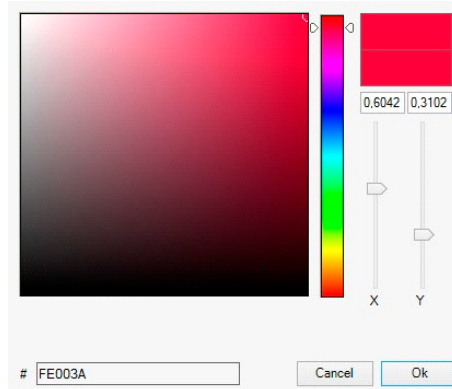

### MaxOnValue

Sets the maximum ON value of the selected group or ecg. When using this action, any maximum On value set in the ETS parameters is automatically overwritten. The permitted value range is between 0 and 100%. This value is reset to the ETS setting after an ETS download.

### Call scene

This function starts a desired scene. The internal scenes 1..16 can be selected.

### Start/Stop effect

This function starts or stops a desired effect. The internal effects 1..16 can be selected.

In principle, every group and ecg can be added to a template independently of the ECG device Types used in the group. Whilst the functions "Set Value", "MinValue" and "MaxValue" work for all device Types, (including, for example, fluorescent lights DT-0 and LED modules DT-6), the colour control functions "Colour Temperature", "Colour XY", "Colour RGBW", "Colour RGB", "Colour HSV" and "Colour HSVW" can only be executed by the connected DT-8 devices.

Other device Types will ignore these actions. This also applies to the selected method. A DT-8 device with XY control, for example, will ignore an RGBW action and vice versa.

If the DT-8 devices within a group or template use different methods but are to perform a colour change at the same time, you need to set up two actions with different functions for the same point in time:

Function	Value	Hour	Minute	Fade Time	M	T	W	T	F	S	S
Colour HSV	H: 246° ; S: 92% ; V: 92%	11	00	1s	<input checked="" type="checkbox"/>	<input checked="" type="checkbox"/>	<input checked="" type="checkbox"/>	<input checked="" type="checkbox"/>	<input checked="" type="checkbox"/>	<input checked="" type="checkbox"/>	<input checked="" type="checkbox"/>
Colour Temperature	CT: 2200°K	11	00	1s	<input checked="" type="checkbox"/>	<input checked="" type="checkbox"/>	<input checked="" type="checkbox"/>	<input checked="" type="checkbox"/>	<input checked="" type="checkbox"/>	<input checked="" type="checkbox"/>	<input checked="" type="checkbox"/>
Set Value	66	11	00	0s	<input checked="" type="checkbox"/>	<input checked="" type="checkbox"/>	<input checked="" type="checkbox"/>	<input checked="" type="checkbox"/>	<input checked="" type="checkbox"/>	<input checked="" type="checkbox"/>	<input checked="" type="checkbox"/>

Once an action table within a template is complete, you need to save the template into the DALI gateway. Please press the download button to do so.

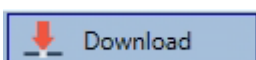

Please remember that time-dependent actions can only be performed if they have previously been saved on the gateway. You can, however, test individual actions via the test button without saving them on the gateway. This does not change the data on the device.

### 15.1.3 Disable/enable

A template can be enabled or disabled in the header of the editor.

This makes it possible to fully prepare a template whilst disabling its execution. This way you can, for example, create two templates: one for a building in normal mode and one for the holiday period. You can now simply enable the required template without having to modify any of the actions. It is even easier to control time-dependencies via external objects. If you select this setting for a template, you can control it via the external objects 2095ff.

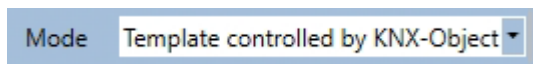

The value on receipt of the object determines whether a template is disabled or enabled.

### 15.1.4 Manual Override

By default, actions are triggered immediately when the action time is reached regardless of any previously executed commands (automatic mode).

However, if the "Manual override" flag is set in a time program, the automatic mode can be stopped by a manual intervention for individual groups / ECGs of the template. Automatic mode is thus manually overridden.

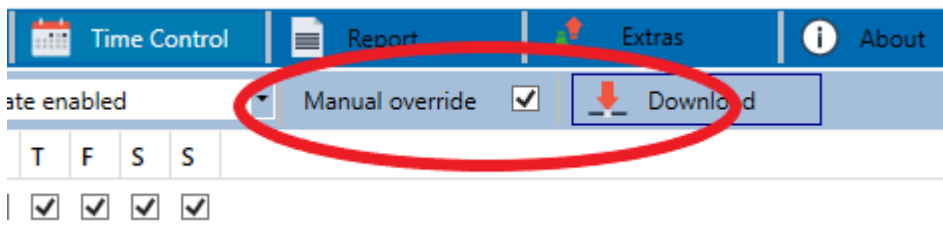

This function is particularly interesting for HCL control applications. If the brightness or color of an element (group / individual ECG) is changed, automatic operation for this element stops. No automatic color adjustment will then be performed at the next action time. The change made by the user will remain until the automatic mode is activated again.

The activation of the automatic mode according to the template takes place at the reception of the next 1 bit Off or On telegram belonging to the element, or at the switching off of the element by another command (e.g. scene value = 0 or broadcast = 0). When an on telegram is received, the last color value regularly desired by an action is set. When an off telegram is received, the group /individual ECG is switched off and the automatic system continues to run in the background. Furthermore, a manual override is always resolved at midnight and automatic mode is automatically reactivated.

### 15.1.5 Export/Import

To reuse a previously created template it is possible to export the template. The resulting xml file can be saved separately so that it can be reused in another project or template.

The export and import commands can be found in the context menu.

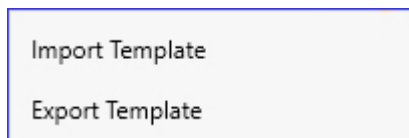



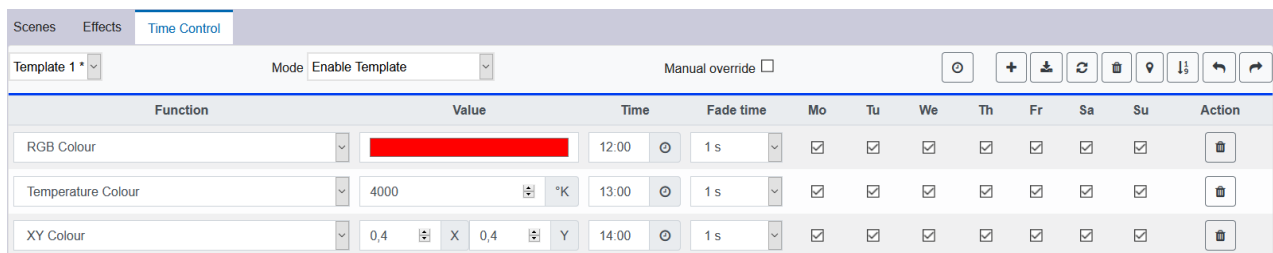

The template is saved as an XLM file in the chosen destination directory.

## 15.2 Time schedules configuration via web server

The assignment settings and the programming of schedules can be done from the website via the web server. After starting the web page, switch to the configuration page for this purpose and select "Templates".



Function	Value	Time	Fade time	Mo	Tu	We	Th	Fr	Sa	Su	Action
RGB Colour		12:00	1 s	<input checked="" type="checkbox"/>	<input checked="" type="checkbox"/>	<input checked="" type="checkbox"/>	<input checked="" type="checkbox"/>	<input checked="" type="checkbox"/>	<input checked="" type="checkbox"/>	<input checked="" type="checkbox"/>	
Temperature Colour	4000 °K	13:00	1 s	<input checked="" type="checkbox"/>	<input checked="" type="checkbox"/>	<input checked="" type="checkbox"/>	<input checked="" type="checkbox"/>	<input checked="" type="checkbox"/>	<input checked="" type="checkbox"/>	<input checked="" type="checkbox"/>	
XY Colour	0,4 X 0,4 Y	14:00	1 s	<input checked="" type="checkbox"/>	<input checked="" type="checkbox"/>	<input checked="" type="checkbox"/>	<input checked="" type="checkbox"/>	<input checked="" type="checkbox"/>	<input checked="" type="checkbox"/>	<input checked="" type="checkbox"/>	

## 15.2.1 Configuration

On the left side you can first select the desired template in the drop-down menu. An "asterisk" indicates that this template has already been defined.

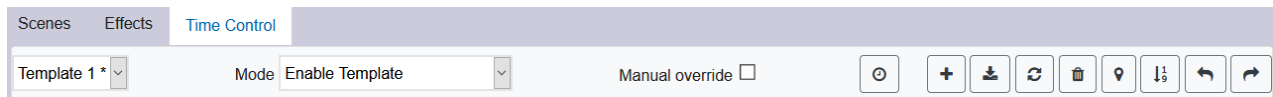

Option "Mode":

The behaviour of the template can be defined, see Chapter: [15.1.3 Disable/enable](#)

Option "Manual override":

Please refer to chapter [15.1.4 Manual Override](#)

The following actions are available for a selected template:



- Read current date/time
- Adding a new entry
- Saving the template
- Reload configuration data
- Delete template
- Assignment of groups and/or ECGs
- Sorting the entries
- Import of the configuration from an xml file
- Export of the configuration to an xml file

Specially for the time schedule it is necessary to ensure that the gateway is working with correct date and time information. By clicking on this icon the current date/time information is being displayed:



### Device Information: Time

2020-11-11 16:46



With the "Plus" button new entries can be added to the selected template.

In the drop-down element you can now select the desired action type, see next chapter.

Depending on the action type, values and colors as well as the time of execution including the desired weekdays can be selected.

## 15.2.2 Types of action

Once you have created an action, set the corresponding function via the selection box. For each function, you can select a value, the time of the action and (if you would like the value to slowly cross-fade) a transition time. If you do not want the action to be performed every day, please enter the days of the week when you want to schedule the action. Please remember that only certain value ranges make sense for each function. In principle any value can be entered in the value field. However, if this value exceeds the possible value range, it is automatically displayed a red border to indicate the not matching input value.

The following functions are possible for an action:



### Set value

Sets the brightness level of a group. The permitted value range is between 0 and 100%.

### MinValue

Sets the minimum dim value of the selected group for relative (4 Bit) and absolute (8 Bit) dimming. When using this action, any minimum dim value set in the ETS parameters is automatically overwritten. The permitted value range is between 0 and 100%.

This value is reset to the ETS setting after an ETS download.

### MaxValue

Sets the maximum dim value of the selected group for relative (4 Bit) and absolute (8 Bit) dimming. When using this action, any maximum dim value set in the ETS parameters is automatically overwritten. The permitted value range is between 0 and 100%.

This value is reset to the ETS setting after an ETS download.

### Colour temperature

This function sets the colour temperature (TC). On the ECG the colour is also changed if the lamp is turned off at the time of the action. You can enter the colour temperature range. The value range permitted is between 1000 and 10000 K but please remember the physical limits of the connected ECGs and lights

### Colour RGBW

Sets the colour values of DT-8 devices that support the colours RGB or RGBW.

On the ECG the colour is also changed if the lamp is turned off at the time of the action.

The values for each colour can be entered separately. The permitted value range for R,G,B and W is between 0 and 255. The final colour is a mixture of the different primary colours according to their percentage.

### **Colour RGB**

Sets the colour values of DT-8 devices that support the colours RGB.

On the ECG the colour is also changed if the lamp is turned off at the time of the action. The values for each colour can be entered separately. The permitted value range for R,G and B is between 0 and 255. The final colour is a mixture of the different primary colours according to their percentage.

### **Colour HSV**

Sets the colour values of DT-8 devices that support the colours RGB.

However, the value is entered by means of saturation, hue and brightness levels in this case.

On the ECG the colour is also changed if the lamp is turned off at the time of the action.

The permitted value range for the hue is between 0 and 360°, the value range for saturation and brightness is between 0 and 100%.

### **Colour HSVW**

In this function, a separate white value (separate channel) is specified in addition to HSV.

### **Colour XY**

Sets the colour temperature of DT-8 devices that support the XY colour space display (XY).

On the ECG the colour is also changed if the lamp is turned off at the time of the action. The X and Y coordinates of the colour can be entered separately. The permitted value range for X and Y is from 0.0 to 1.0. Please remember the physical limits of the connected ECGs/lights. Not every colour from the colour spectrum can be set.

### **MaxOnValue**

Sets the maximum ON value of the selected group or ecg. When using this action, any maximum On value set in the ETS parameters is automatically overwritten. The permitted value range is between 0 and 100%. This value is reset to the ETS setting after an ETS download.

### **Call scene**

This function starts a desired scene. The internal scenes 1..16 can be selected.

### **Start/Stop effect**

This function starts or stops a desired effect. The internal effects 1..16 can be selected.

In principle, every group can be added to a template independently of the ECG device Types used in the group. Whilst the functions "Set Value", "MinValue" and "MaxValue" work for all device Types, (including, for example, fluorescent lights DT-0 and LED modules DT-6), the colour control functions "Colour Temperature", "Colour XY", "Colour RGBW", "Colour RGB" and "Colour HSV" can only be executed by the connected DT-8 devices. Devices of other device types will ignore the actions. This also applies with regard to the selected procedure.

Other device Types will ignore these actions. This also applies to the selected method. A DT-8 device with XY control, for example, will ignore an RGBW action and vice versa. If the DT-8 devices within a group or template use different methods but are to perform a colour change at the same time, you need to set up two actions with different functions for the same point in time:

### 15.2.3 Disable/enable

In the page header, the respective template can be released or locked.

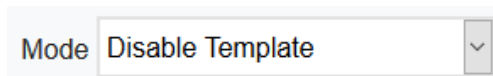

This option allows you to prepare templates completely but block their execution. For example, two templates could be created: One for the normal operation of a building and another one for the holiday period. By simply selecting the desired template, the desired template can be released without having to manipulate any actions. Time dependencies can be implemented even more conveniently using external objects. If this setting is selected for a template, the control can be carried out via the external objects 2095ff.

### 15.2.4 Manual Override

Please refer to chapter [15.1.4 Manual Override](#)

### 15.2.5 Assignment of groups and ECGs

By selecting the "Assignment" button, the desired groups and ECGs that are to work with this schedule can be selected.



Select Template Members



Groups

1  2  3  4  5  6  7  8

9  10  11  12  13  14  15  16

Ecgs

1  2  3  4  5  6  7  8

9  10  11  12  13  14  15  16

### 15.2.6 Programming the time programs

Once all entries for all desired templates have been made, the settings must be loaded from the browser into the device. This is done by pressing the "Save" button.



### 15.2.7 Export/Import

In order to be able to reuse an already created template, it is possible to export it. The created XML file can be saved separately to be used again in another project or in another template. The export or import can be done with the following buttons:



Import of a time program



Export of a time program

The template is saved as an XLM file in the desired target directory.

### 15.3 Timer

To ensure the safe operation of the time control module the exact time and date are required on the device. This has to be provided by the KNX in form of 3 Byte communication objects. The precision of the DALI gateway's internal time calculation is limited. It is therefore essential to update the time at least once a day. When the application is started the device automatically sends a read request for time and date to the KNX bus.

The time control module remains completely disabled until an updated time has been received. Actions are only performed after receipt of a valid time. Please remember that the 3 Byte time object also transmits information about the current weekday (Monday – Sunday). (For some KNX timers this is configurable). If a 3 Byte object is received without this information, the weekday is not checked. This means that an action which has, in fact, only been enabled for Saturday and Sunday would also be performed on a Monday.

As the date is not calculated internally, the DALI gateway automatically sends a read request to the date object at 00:01 and at 00:04. At the same time, the time object is also automatically queried. A further read request is sent at 3:01. This avoids any potential failures when clocCW change to daylight saving time and vice versa.

## 16 Self-contained battery emergency lights

The SpaceLogic KNX DALI Gateway Pro also supports ECGs for the control of self-contained battery emergency lights. (Device Type 1 according to EN 62386-202). Such devices contain a battery within the lamp that will operate the light for a certain time period in case of loss of power supply.

### 16.1 Self-contained battery emergency lights

Principally a distinction is made between switchable and non-switchable devices for self-contained battery lamps. A switchable device can be directly connected to a lamp just like a 'normal' ECG. In normal mode the light (usually an LED) can be switched and dimmed via DALI. The standard switch parameters and objects are available for these devices.

In contrast to the 'switchable' device, a 'non-switchable' device (converter) can only control the connected lamp in an emergency. The light is normally either always on or always off. As these devices do not allow direct switching, there are no objects available for this purpose.

During both new and post-installation the SpaceLogic KNX DALI Gateway Pro recognises automatically, whether the connected device is a 'switchable' or 'non-switchable' ECG.

Sometimes special, non-switchable converters are used together with "normal" DALI ECGs in a light. These lights are therefore called emergency lights with 2 DALI devices. The two ECGs make a device pair that shares a common light. The 'non-switchable' device uses the DALI communication to query the device status and to initiate mandatory test phases. The switchable device controls the light in normal mode.

However, because of the DALI structure with its random assignment of short addresses, the pairing of a 'normal' device with a 'non-switchable' device does not occur automatically. It has to be performed manually on the parameter page in ETS. The assignment is crucial for failure analysis purposes as 'non-switchable' devices usually share the connected lamp with a 'normal' device. Without the assignment, a lamp failure may be double-counted. In addition, the 'normal' ECG in a pair is usually automatically disconnected from the power supply when the emergency light is tested. This loss of function generates an ECG failure. However, by making a pair, the gateway recognises automatically, whether a real ECG failure has occurred or whether the corresponding converter has simply been tested. Only real ECG failures are taken into account for the analysis.

## 16.2 Identification of self-contained battery emergency lights

For identification after new/reinstalled single-battery emergency lights, the identification process is started when "flashing mode" is selected. Usually the status LED of the emergency light flashes. However, please observe the respective description of the light. Since the status LED is not executed or visible with some lights, a function test can be started alternatively. During the function test, the ECG usually switches the luminaire on for a few seconds.

## 16.3 Converter inhibit mode

Self-contained battery emergency lights always change into emergency mode if there is a power supply failure. The lamp is now operated by the internal battery. However, it may become necessary at times to cut off the power supply, for example during maintenance work or the commissioning phase of a building. To prevent the lights from switching into emergency mode, the converters connected to the SpaceLogic KNX DALI Gateway Pro can be disabled via the pushbuttons and display on the device (see above). This converter inhibit mode is only available for all connected devices at the same time. If the power supply is turned off within 15 minutes after activating the mode, the connected lights do not change into emergency mode and the lights remain switched off. When the power resumes, the lights return to normal. If the 15 minutes run out without a power loss, all converters are automatically reset to normal mode.

## 16.4 Test mode for self-contained battery emergency lights

The SpaceLogic KNX DALI Gateway Pro supports the execution and recording of mandatory tests for self-contained battery emergency lamps.

**Attention:** The legal regulations and norms vary in different countries. Please make sure that you comply with all country-specific requirements.

The SpaceLogic KNX DALI Gateway Pro supports functional tests, long duration tests and battery status tests. Functional and duration tests can be started externally via KNX telegrams (1 Byte telegrams, see below) or via the device website. Alternatively you may choose to set automatic test intervals. This means tests are performed automatically via the connected converters. (Please check the converter description for the exact function). After a test has been completed, the test results are available on the KNX bus via communication objects and they may be recorded in the visualisation. The corresponding objects are updated with the test result and automatically sent after every new test. Please see chapter: [19.1.3.2 Objects for emergency](#) for the exact function.

Alternatively, test results can be displayed on the website if you select the respective converter.

## 16.5 Emergency Test Results

### 16.5.1 DCA report

The "Report" tab displays statistical data on the fault status of the connected ECGs, as well as the test reports of the connected emergency luminaires. In the upper part the following information is displayed:

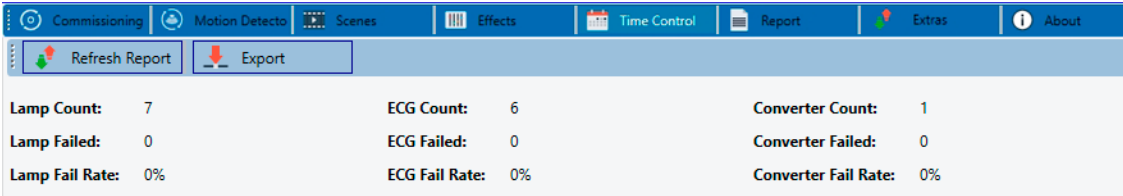

Refresh Report		Export			
Lamp Count:	7	ECG Count:	6	Converter Count:	1
Lamp Failed:	0	ECG Failed:	0	Converter Failed:	0
Lamp Fail Rate:	0%	ECG Fail Rate:	0%	Converter Fail Rate:	0%

- Lamp Count
- ECG Count
- Converter Count
- Lamp failed
- ECG failed
- Converter failed
- Lamp failure rate
- ECG failure rate
- Converter failure rate

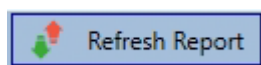

Press the "Refresh" button to display the test reports (Result of the last emergency lighting test of all emergency lights). This information is directly obtained from the emergency lights via a DALI command.

#### Date

**ECG:** Number of ECGs (ETS Definition)

**ECG Name:** Name of the ECG assigned by the ETS

**Mode:** FT= Function test; DT: Duration test; BT: Battery test

**Result:** During a battery test the battery status is displayed; during a duration test the time of the test is displayed.

**Converter:** green: no failure; red: Converter was faulty during the test (DALI QUERY 252: bit 0)

**Duration:** green: no failure; red: Duration of the battery is insufficient (DALI QUERY 252: bit 1)

**Battery:** green: no failure; red: Battery faulty (DALI QUERY 252: bit 2)

**Lamp:** green: no failure; red: Emergency light is faulty (DALI QUERY 252: bit 3)

**Delay:** green: no failure; red: Maximum delay time has been exceeded during function or duration test (DALI QUERY 252: bit 4 oder bit 5)

**Test:** green: ok

#### 16.5.1.1 Detailed information about emergency lights

Double-click on an emergency light (converter) to display detailed information.

Date	ECG	ECG Name	Mode	Result	Converter	Duration	Battery	Lamp	Delay	Test
2012-01-01 00:20:19	5	ECG05 (T105)	FT	?						
		Converter Statemachine:	1			Emergency Status:	0			
		Emergency Mode:	130			Emergency Failure:	0			
		FT Pending:	No			DT Pending:	No			
		FT Running:	No			DT Running:	No			

Converter status: Status according to DTP 244.600:

- 0: Unknown
- 1: Normal mode active, all OK
- 2: Inhibit mode active
- 3: Hardwired inhibit mode active
- 4: Rest mode active
- 5: Emergency mode active
- 6: Extended emergency mode active
- 7: FT in progress
- 8: DT in progress

**Emergency light status:** Status according to DALI Query\_Emergency\_Status 253

**Emergency light mode:** Status according to DALI Query\_Emergency\_Mode 250

**Emergency light failure:** Status according to DALI Query\_Failure\_Status 252

### 16.5.1.2 Exporting test results

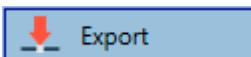

Press the Export button to save the test results in an xml file. The file can be saved in any location.

## 16.5.2 Website Report

The test results of the emergency lights can be displayed on the website via the web server. After starting the web page, switch to the diagnostics page for this purpose and select "Report".

Short Address	ETS Number	ECG Description	Date	Test	Converter Failure	Duration Failure	Battery Failure	Lamp Failure	Delay Failed	Test Failed	Result	Action	Info
0	1	ECG No. 1	2022-04-04 06:43:26	♥	●	●	●	●	●	●	100 %	Functional Test ▾ ▶	i
1	3	ECG No. 3	2022-04-04 07:57:41	♥	●	●	●	●	●	●	100 %	Long Duration Test ▾ ▶	i
2	2	ECG No. 2	2022-04-04 08:21:32	♥	●	●	●	●	●	●	99 %	Battery Test ▾ ▶	i

This table lists all configured emergency luminaires:

**Short address:** real address of the ECG

**ECG:** Number of the ECG (ETS definition)

**ECG Description:** the name given to this ECG by the ETS

**Date:** Date of the last test result

**Converter:** green: no error; red: converter was faulty during test (DALI QUERY 252: bit 0)

**Duration:** green: no error; red: battery rated time insufficient (DALI QUERY 252: bit 1)



**Battery:** green: no error; red: battery defective (DALI QUERY 252: bit 2)

**Lamp:** green: no error; red: emergency lighting lamp defective (DALI QUERY 252: Bit 3)

**Delay:** green: no error; red: maximum delay time in function test or duration test exceeded (DALI QUERY 252: bit 4 or bit 5)

**Result:** During a battery test, the charge state of the battery is displayed; during an endurance test, the time of the test is displayed

Testing:

	FT= Functoin Test
	DT: Duration Test
	BT: Battery Test

Action:

Here you can choose between function test, endurance test and battery test. The test is started with the following key:

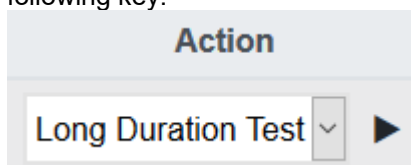

### 16.5.2.1 Detailed information of an emergency lamp

Info: The Info button displays detailed information:

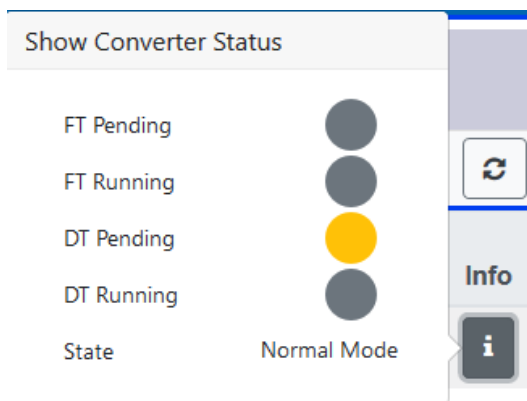

### 16.5.2.2 Exporting the test results in xml



Press the Export button to save the test results in an xml file.  
The storage location is freely selectable.

### 16.5.2.1 Exporting the test result as HTML Print



By pressing the Export button, the test results are summarized in an HTML page and prepared for printing. The printout can be started via the browser.

#### Report of Emergency Lights

Date of Report 2022-04-01

---

**General Information**

Project ID	Project
Building ID	Building
Zone ID	Zone
Device	e64Pro
Total EL installed	3
Total EL in general error	0

---

**Emergency Test Summary**

Total EL Summary	
- Duration Test failed	0
- Functional Test failed	0
- Duration Test pending	0
- Functional Test pending	0

Start of Test Period 31.3.2022, 22:59:03

End of Test Period 1.4.2022, 14:29:08

---

Name and Surname

---

Date and Signature

Date	Short Address	ECG Number	Test Type	Result	Status
2022-04-01 07:29:39	0	1	DT	90 min	
2022-03-31 22:59:03	1	3	DT	60 min	
2022-04-01 14:29:08	2	2	BT	64 %	

The current status is displayed in the "Status" column. If a test is pending or has been started, this is indicated by the abbreviations FTW (function test waiting) or DTW (duration test waiting). The last completed test is displayed with date/time and result.

Date	Short Address	ECG Number	Test Type	Result	Status
2022-04-01 07:29:39	0	1	DT	90 min	FTW
2022-03-31 22:59:03	1	3	DT	60 min	
2022-04-01 14:29:08	2	2	BT	64 %	

## 17 DCA Extras

The menu item Extras offers further special functions.

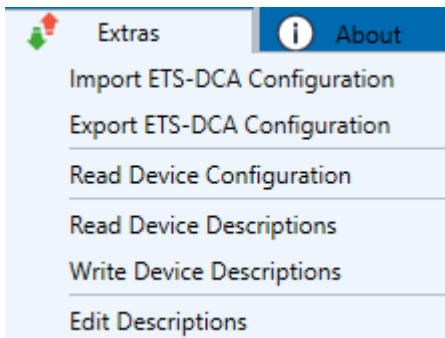

### Import device configuration

A previously saved device configuration can be loaded into the ETS with this function.

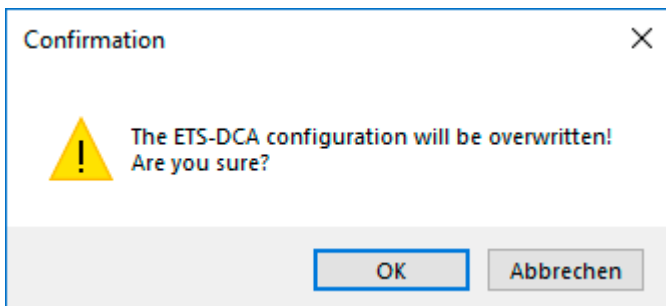

Please remember that all DCA data in the ETS will be overwritten with this data. Press the "Restore" button under commissioning in order to load the configuration onto the Dali gateway. See chapter: [11.1.9 Restoring the DALI configuration.](#)

Apart from the Dali configuration, important ETS parameters are also written back. These include:

- Group assignment of the ECGs
- Device types and selection of colour control
- Type of input devices
- Type of light control

### Export device configuration

The ETS DCA configuration can be saved as an xml file.

### Read device configuration

All data from the DALI gateway is exported and transferred to the ETS-DCA configuration.

**Note:** This is especially important if you have previously worked with the website. Description texts are not read automatically. To do this, the separate menu item "Read description texts" must be selected.

### Read description texts

The description texts of the ECGs, groups and scenes can also be saved on the DALI gateway. The descriptions on the device are available on the device website. Please remember that the device allows only 20 characters per name. In case the website was previously used for commissioning, the texts are transferred to the ETS.

### Write description texts

The description texts of the ECGs, groups and scenes can be saved on the DALI gateway. The descriptions on the device are available on the device website.

### Edit Descriptions

The description texts of the ECGs, the groups and input devices can be defined separately under this menu item

## 17.1 Menu: Edit Descriptions

For each category the description texts can be entered separately.

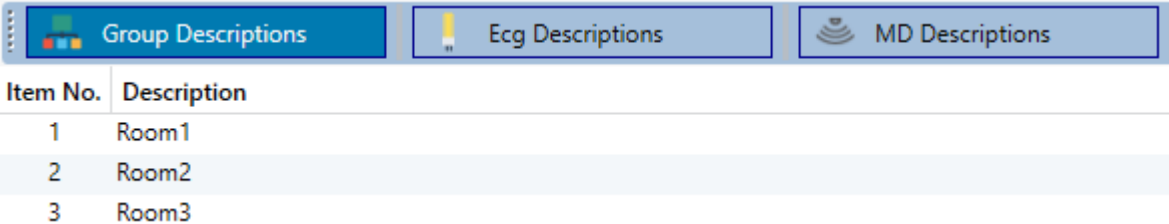

Item No.	Description
1	Room1
2	Room2
3	Room3

In addition, it is possible to import, export or delete texts by right-clicking on a line in the context menu:

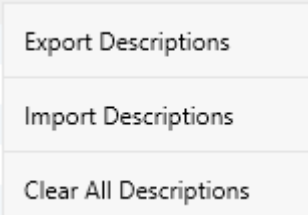

Export Descriptions
Import Descriptions
Clear All Descriptions

There are 2 format provided for Export, resp. Import:

- xml
- txt

By default, the "xml" format is selected. The following is an example of the group export:

```
<?xml version="1.0" encoding="UTF-8" standalone="yes"?>
<GRP_TEXT>
<text index="1" description="Room 1" />
<text index="2" description="Room 2" />
<text index="3" description="Room 3" />
<text index="4" description="Room 4" />
<text index="5" description="" />
<text index="6" description="" />
<text index="7" description="" />
<text index="8" description="" />
<text index="9" description="" />
<text index="10" description="" />
<text index="11" description="" />
<text index="12" description="" />
<text index="13" description="" />
<text index="14" description="" />
<text index="15" description="" />
<text index="16" description="" />
</GRP_TEXT>
```

**Hint (xml):** If you do not want to overwrite all texts, you can simply omit the corresponding indices.

**Hint (txt):** When using the txt format, it should be noted that this file is read in line by line. An entry that is not to be changed must therefore be defined as an "empty" line. An entry that is to be deleted is marked with single quotation marks.

## 18 Commissioning/operating via display and pushbuttons

You can commission the connected DALI segment and set and change some functions and tests via the three pushbuttons (MOVE, Set/Prg, ESC) and the 2x12 character display on the front of the device. The user concept is menu-based. Depending on the menu position, you can select two sub-levels. The current menu position is shown on the display. To navigate within the menu, press the pushbuttons briefly.

The Move key is used to select the next menu item within a level. With a short push on the Prg/Set button you reach the respective subordinate level. Pressing the ESC key causes leaving the selected level and returning to the superordinate level.

### 18.1 Main menu level 1

The main menu (level 1) has the following structure:

DALI GATEWAY  
Pro - V1.0

The product name and firmware version are displayed. The sub-menu can be used to set the display language.

NETWORK  
IP ADDRESS

This sub-menu displays the IP address set in the ETS or assigned by the DHCP server.

NEW  
INSTALLATION

When a DALI segment is newly installed, use the sub-menu to reset the connected DALI devices and automatically search for ECGs.

**Unlike with a new installation that was started through DCA or web server, the ECGs in this case are directly assigned 1:1 to the real ECGs.**

POST  
INSTALLATION

Use this sub-menu to start the automatic search process and possibly adjust the configuration following a post-installation of DALI ECGs.

ECG EASY  
REPLACEMENT

Use this sub-menu to active the ECG quick exchange function and possibly program and integrate individually replaced ECGs into the system.

GROUP  
ASSIGNMENT

Identifies ECGs and assigns them to DALI groups.

GROUP  
TEST

Switches programmed groups for test purposes.

SCENE  
TEST

Tests individually programmed scenes.

SYSTEM  
TEST

Use this sub-menu to individually load any existing system failures.

MAINTENANCE  
ECG/LAMP

Resets operating hours.

CONVERTER  
INHIBIT MODE

Activates the converter inhibit mode in the installation phase.

To perform a function or change a configuration within a sub-menu, go to the respective position and change into programming mode. To change into programming mode, hold the Prg/Set button for more than 2 seconds. Once the function is in programming mode, a →-symbol appears in the display. If the programming mode is active, use the Move button to change a parameter or setting. Briefly press the Prg/Set button again to complete the process and save the set parameter or activate the function.

## 18.2 Sub-menu level 2

### 18.2.1 Sub-menu language

The sub-menu language has the following structure:

DALI GATEWAY  
Pro - V3.0

The product description and firmware version are displayed. The display language can be set in the sub-menu.

LANGUAGE  
GERMAN

The currently set display language is shown. Hold the Prg/Set button to change into programming mode. Use the MOVE button to choose from one of the following languages: GERMAN, ENGLISH, FRENCH, SPANISH, ITALIAN, DUTCH, SWEDISH, DANISH. Briefly press the Prg/Set button again to save the configuration. The display now works in the selected language.

**Hint:** The language will be activated after a restart of the device.

### 18.2.2 Sub-menu IP network / address

The sub-menu IP/address has the following structure:

NETWORK  
IP ADRESSE

Briefly press the Prg/Set button to change from the main menu IP ADDRESS to the sub-menu.

DHCP: 192.  
168.004.xxx

This sub-menu displays the IP address currently set in the ETS or assigned by the DHCP-Server.

### 18.2.3 Sub-menu new installation

The sub-menu new installation has the following structure:

NEW  
INSTALLATION

Briefly press the Prg/Set button to change from the main menu NEW INSTALLATION to the sub-menu SEARCH ECGs via PROG-MODE.

SEARCH ECGs  
via PROG-MODE

This sub-menu displays the IP address currently set in the ETS or assigned by the DHCP-Server.

FOUND  
ECGs: xx

Use this sub-menu to reset the connected DALI devices and automatically search for ECGs during a new installation.

## 18.2.4 Sub-menu post-installation

The sub-menu post-installation has the following structure:

POST-  
INSTALLATION

Briefly press the Prg/Set button to change from the main menu POST- INSTALLATION to the sub-menu SEARCH ECGs via PROG-MODE.

SEARCH ECGs  
via PROG-MODE

Hold the Prg/Set button to change into programming mode. Briefly press the Prg/Set-button again to start the verification and search process. The device searches for the connected ECGs via their long address and automatically compares them to the previous configuration

DELETED  
ECGs: x

If ECGs have been removed from the DALI segment, the entries are deleted from the device. The number of deleted devices is displayed during the verification process

NEW  
ECGs: x

After that, the DALI segment is searched for newly installed devices. Newly added ECGs are automatically reset and any previously programmed parameters and group assignments are deleted. Depending on the number of connected ECGs the search process may take a few minutes. During the search process, the number of newly found devices is shown in the display.

DELTED/NEW  
ECGs: x/x

Once the whole process (verification and search) is complete, the display shows both the deleted and the newly found ECGs (deleted devices / new devices from left to right, see picture on the left). Press the ESC button (or wait for about 30 seconds) to return to the level above.).

## 18.2.5 Sub-menu ECG quick exchange

The sub-menu ECG quick exchange has the following structure:

ECG QUICK  
EXCHANGE

Briefly press the Prg/Set button to change from the main menu ECG QUICK EXCHANGE to the sub-menu SEARCH ECGs via PROG-MODE.

SEARCH ECGs  
via PROG-MODE

Hold the Prg/Set button to change into programming mode. Briefly press the Prg/Set-button again to start the quick exchange. The device first check if one or several ECGs in the system were faulty. It then automatically looCW for newly connected ECGs in the segment. The quick exchange is only possible if just one ECG in the segment was faulty and one new ECG is found. If the process is successful, the number of the replaced ECG is shown in the display.

ECG xx  
REPLACED

If the search process cannot be completed because the required conditions are not met, an failure code appears in the display.

```
ERROR  
TYPEE xx
```

If the search process cannot be completed because one of the conditions necessary for the quick exchange is not fulfilled, an error code is shown in the display. The displayed error codes have the following meaning:

- **Failure Type 7:** No faulty ECG
- **Failure Type 8:** More than one ECG faulty
- **Failure Type 9:** No new ECG found
- **Failure Type 10:** ECG has wrong device Type
- **Failure Type 11:** More than one new ECG

Press the ESC button (or wait for about 30 seconds) to return to the level above.

## 18.2.6 Sub-menu group assignment

The sub-menu group assignment has the following structure:

```
GROUP  
ASSIGNMENT
```

Briefly press the Prg/Set button to change from the main menu GROUP ASSIGNMENT to the sub-menu. Within this menu the individual ECGs that were found during the search process can be assigned to 16 DALI groups and previous assignments can be modified.

```
ECG NR.: xx  
GROUP: --
```

Briefly press the MOVE button to run through the different ECGs. The number of the selected ECG is shown in the first display line. As long as the ECG is selected, the connected lamp is flashing. The programmer can thereby determine which lamp is assigned to the number.

```
KONV. NR.: xx  
GROUP: --
```

If the selected device is a converter for emergency lights, the selection sets the device into identification mode and the display shows the word CONV. For identification purposes, the function LED on the converter flashes during the test (see user manual for the converter).

```
KONV. NR.: xx  
GROUP: xx
```

Hold the Prg/Set button to change into programming mode. Briefly press the MOVE button again to select the group that you want to assign the ECG to. If the group is selected, briefly press the Prg/Set button to confirm and save the setting. Press the ESC button (or wait for about 30 seconds) to return to the level above.

## 18.2.7 Sub-menu group test

The sub-menu group test has the following structure:

```
GROUP  
TEST
```

Briefly press the Prg/Set button to change from the main menu GROUP TEST to the sub-menu. Within the menu, groups can be switched either individually or all together (ALL GROUPS TEST = BROADCAST) to test the installation.

```
GROUP: X  
TEST
```

Briefly press the MOVE button to run through the individual groups. The number of the selected group is shown in the first display line.

```
GROUP: X  
---> OFF
```

Hold the Prg/Set button to change into programming mode. Briefly press the Move button to select whether you would like to switch the group on or off. Briefly press the Prg/Set button to execute the selected command. Press the ESC button (or wait for about 30 seconds) to return to the level above.

## 18.2.8 Sub-menu scene test

The sub-menu scene test has the following structure:

```
SCENE  
TEST
```

Briefly press the Prg/Set button to change from the main menu SCENE TEST to the sub-menu. Within the menu you can invoke all scenes for test purposes or program newly set light scenarios into the scene.

```
SCENE: X  
TEST
```

Briefly press the MOVE button to run through the individual scenes. The number of the selected scene is shown in the first display line.

```
SCENE: X  
----> INVOKE
```

Hold the Prg/Set button to change into programming mode. Briefly press the Move button to choose whether you would like to invoke or save a scene. Briefly press the Prg/Set-Taste button to execute the selected command and either invoke or save the scene. Press the ESC button (or wait for about 30 seconds) to return to the level above.

## 18.2.9 Sub-menu system test

The sub-menu system test has the following structure:

```
SYSTEM  
TEST
```

Briefly press the Prg/Set button to change from the main menu SYSTEM TEST to the sub-menu. Within the menu you can check for any potential failures.

```
DALI  
NO ERROR
```

If there is no failure, this is shown in the display. The following failures can be recognised by the system. They are shown in the display and also simultaneously set off the red failure LED:

```
DALI  
ERROR
```

- DALI short-circuit
- Lamp fault with the lamp or ECG number being displayed
- ECG failure with display of the ECG number
- No KNX Bus

In case of a DALI short-circuit, no further failures can be recognised. For all other failure Types, several failures can be recognised at the same time. Within the menu you can toggle between different failures by briefly pressing the Move button.

```
LAMP xx  
NO ERROR
```

The number of the ECG is displayed for lamp failures. This means that an failure can be easily localised.

```
ECG xx  
NO ERROR
```

The number of the ECG is displayed for ECG failures. This means that an failure can be easily localised.

```
KNX  
NO ERROR
```

If there are no failures, this is shown on the display.

## 18.2.10 Sub-menu maintenance ECG/lamp

The sub-menu maintenance ECG/lamp has the following structure:

```
MAINTENANCE
ECG/LAMP
```

Briefly press the Prg/Set button to change from the main menu MAINTENANCE ECG/LAMP to the sub-menu. Within the menu you can start the burn-in of a lamp and reset the reader for its operating hours.

```
ECG NR. :   xx
xxx  h
```

Briefly press the MOVE button to run through the individual ECGs. The number of the selected ECG is shown in the first display line. Line 2 shows the number of operating hours since the last reset.

```
ECG. NR. :   xx
RESET
```

Hold the Prg/Set button to change into programming mode. Briefly press the Prg/Set button to execute the selected command. Press the ESC button (or wait for about 30 seconds) to return to the level above.

## 18.2.11 Sub-menu converter inhibit mode

The sub-menu converter inhibit mode has the following structure:

```
CONVERTER
INHIBIT MODE
```

Briefly press the Prg/Set button to change from the main menu CONVERTER INHIBIT MODE to the sub-menu. Within the menu you can turn on the Inhibit Mode for all connected self-contained battery emergency lights. If the mains power supply is turned off within 15 minutes from activating the Inhibit Mode, the lights do not change into emergency mode but remain switched off. Particularly during the initialisation phase of a building this operating mode may be required to prevent the emergency lights from being turned on constantly

```
INHIBIT MODE
via PROG-MODE
```

Hold the Prg/Set button to change into programming mode.

```
INHIBIT
CONVERTER?
```

Briefly press the Prg/Set button again to activate the Inhibit Mode. Press the ESC button (or wait for about 30 seconds) to return to the level above.

## 19 ETS communication objects

The SpaceLogic KNX DALI Gateway Pro communicates via the KNX bus based on a powerful communication stack of the System B type. Altogether 2110 communication objects are available, which are described below separated by function bloc.

**Note:** Up to 1000 group addresses can be used in encrypted form, see chapter: [2.1 Secure Usage](#).

### 19.1 General objects

#### 19.1.1 General objects behavior

Object	Object name	Function	Type	Flags
1	Time	Time	3 Byte 10.001	CWT
This object is used to set the time. The time must be provided by a central timer and updated at least twice a day.				
2	Date	Date	3 Byte 11.001	CWT
This object is used to set the date. The date must be provided by a central timer and updated at least twice a day. Leap years and change-over to and from daylight saving time are not taken into consideration during internal calculations of time and date. Therefore please pay attention that the timer sends the correct date on these occasions.				
10	Activate Panic mode	Activate/Stop	1 Bit 1.010	CW
Use this object to activate or stop the panic mode via the bus.				
11	Activate Test mode	Activate/Stop	1 Bit 1.010	CW
This object is used to activate or stop the test mode via the bus.				
12	Activate Night mode	Activate/Stop	1 Bit 1.010	CW
This object is used to activate or stop the night mode via the bus.				

#### 19.1.2 General objects analysis and service

Object	Object name	Function	Type	Flags
13	General failures	Yes/No	1 Bit 1.005	CRT
This object is used to report the presence of a general failure in the connected DALI segment independent of its type.				
14	DALI failure	Yes/No	1 Bit 1.005	CRT
This object is used to report the presence of a DALI short-circuit in the connected DALI segment.				
15	General Failure Exceed Theshold	Yes/No	1 Bit 1.005	CRT
This object is used to report that the total of all lamp, ECG and converter failures recognised by the gateway, exceeds the set threshold.				

MTN6725-0101

16	General Failure in Total	Value	1 Byte 5.010	CRT
This object is used to report the total number of all lamp, ECG and converter failures recognised by the gateway. Please remember that for each connected device an failure is counted just once. A simultaneous lamp failure in case of an ECG or converter failure cannot be recognised or counted.				
16a	General Failure in %	Value	1 Byte 5.001	CRT
This object is used to report the failure rate as a percentage of all lamp, ECG and converter failures recognised by the gateway. Please remember that for each connected device an failure is counted just once. A simultaneous lamp failure in case of an ECG or converter failure cannot be recognised or counted.				
17	Lamp Failure Exceed Theshold	Yes/No	1 Bit 1.005	CRT
This object is used to report that the total of all lamp failures recognised by the gateway exceeds the set threshold.				
18	Lamp Failure in Total	Value	1 Byte 5.010	CRT
Reports the total amount of lamp failures recognised by the gateway.				
18a	Lamp Failure in %	Value	1 Byte 5.001	CRT
Alternatively, this object is used to report the failure rate as a percentage of the total number of lamps in the DALI segment.				
19	ECG Failure Exceeds Theshold	Yes/No	1 Bit 1.005	CRT
This object is used to report that the total of all lamp failures recognised by the gateway exceeds the set threshold.				
20	ECG Failure in Total	Value	1 Byte 5.010	CRT
Reports the total amount of ECG failures recognised by the gateway.				
20a	ECG Failure in %	Value	1 Byte 5.001	CRT
Alternatively, this object is used to report the failure rate as a percentage of the total number of lamps in the DALI segment.				
21	Converter Failure Exceeds Theshold	Yes/No	1 Bit 1.005	CRT
This object is used to report that the total of all converter failures recognised by the gateway exceeds the set threshold.				
22	ECG Failure in Total	Value	1 Byte 5.010	CRT
Reports the total amount of converter failures recognised by the gateway.				
22a	ECG Failure in %	Value	1 Byte 5.001	CRT
Alternatively, this object is used to report the failure rate as a percentage of the total number of converters in the DALI segment.				
23	Status On/Off Group 1 – Group 16	Status	4 Bytes 27.001	CRT
Activates the status display for groups 1 - 16.				
24	Status On/Off ECG 1 - ECG 16	Status	4 Bytes 27.001	CRT
Sends the switch status for ECGs 1 - 16. Each value >0% is interpreted as ON.				

25	Status On/Off ECG 17 - ECG 32	Status	4 Bytes 27.001	CRT
Sends the switch status for ECGs 17 - 32. Each value >0% is interpreted as ON.				
26	Status On/Off ECG 33 - ECG 48	Status	4 Bytes 27.001	CRT
Sends the switch status for ECGs 33 - 48. Each value >0% is interpreted as ON.				
27	Status On/Off ECG 49 - ECG 64	Status	4 Bytes 27.001	CRT
Sends the switch status for ECGs 49 - 64. Each value >0% is interpreted as ON.				
28	Status Failure Lamp/ECG	Status	1 Byte 238.600	CRT
Sends the switch status of individual lamps in the DALI segment when the system is started or when a change has taken place. Bit 0 - 5 refer to the number of the ECG. Bit 7 represents an ECG failure, Bit 6 a lamp failure. For example:  <pre> Bit 7 6 5 4 3 2 1 0 ECG 5 / ECG failure   1 0 0 0 0 1 0 0 ECG 6 / Lamp failure  0 1 0 0 0 1 0 1 </pre> If a value is received where Bit 7 and Bit 6 are set, it is interpreted as a status query. For example:  <pre> Bit 7 6 5 4 3 2 1 0 ECG 5 / Query         1 1 0 0 0 1 0 0 </pre> The gateway responds with the current status of the queried ECG.  <pre> Bit 7 6 5 4 3 2 1 0 ECG 5 / ECG failure   1 0 0 0 0 1 0 0 </pre>				
29	Total Active Power	Value	4 Bytes 14.056	CRT
This object provides the total active power of all ECGs of device type 51 according to DALI part 252 which are installed.				
29a	Total Active Energy	Value	4 Byte 13.010	CRT
This object provides the total active energy of all ECGs of device type 51 according to DALI part 252 which are installed.				
2406-2413	Sensor x, Input Device Error	Yes/No	1 Bit	CRT
These objects transmit the error status of an ETS sensor (motion detector or generic input). An ETS sensor can be linked to different instances of different real input devices. As soon as a linked instance reports an error, this is communicated via these objects.				
2414-2421	Generic x Input Device Error	Yes/No	1 Bit	CRT
These objects transmit the error status of an ETS Generic elements. As soon as a linked instance reports an error, this is communicated via these objects.				
2422-2429	Push Button x Input Device Error	Yes/No	1 Bit	CRT
These objects transmit the error status of an ETS Push Button. An ETS Push Button can be linked to different instances of different real input devices. As soon as a linked instance reports an error, this is communicated via these objects.				

### 19.1.3 General objects special functions

Object	Object name	Function	Type	Flags
34	Scene invoke / programm	Start/Program	1 Byte 18.001	CW
Scenes can be called up or programmed via this object. Up to 16 scenes are available in the Dali Gateway. To program a set scene, the top bit must be set:				
	Start	Program		
Scene 1	0	128		
Scene 2	1	129		
.....				
Scene 16	15	143		

35.. 50	Scene x, Dimming	Brighter/Darker	4 Bit 3.007	CW
Scene 1 .. 16 can be dimmed relatively via this object. Dimming is set with bit 4, dimming with bit 4 deleted. Bits 1..3 indicate the respective step sizes. Bit 1..3 deleted is interpreted as a stop telegram. <b>Note:</b> The min / max values of the respective groups that were defined with the ETS are also taken into account when dimming the scenes.				
51	Effects start / stop	Start/Stop	1 Byte	CW
Effects can be started or stopped via this object. Up to 16 effects are available in the Dali Gateway. The top bit must be set to start an effect. Stopping takes place when bit 7 is deleted.				
	Effect Off	Effect On		
Effect 1	0	128		
Effect 2	1	129		
.....				
Effect 16	15	143		

### 19.1.3.1 Objects for Energy Saving

Each group as well as each ECG can be de-energized via a separate actuator. Up to 16 energy-saving objects are provided in the parameters for this purpose.

52.. 67	Energy Saving Object 1.. 16	On / Off	1 Bit 1.001	CRT
With the appropriate assignment in the parameters, this object is switched off when associated groups or ECGs are switched off. This allows a separate power supply to be switched off. If the associated groups or ECGs are controlled again with a value > 0%, this object is switched on again before. In this case, a minimum time delay is programmed so that the ECGs are ready for operation again, see Parameterpage: <a href="#">Special Functions</a>				

### 19.1.3.2 Objects for emergency

Two types of communication objects are offered on the device. The selection is defined via parameters:



The objects are explained with the respective ECGs.

### 19.1.4 Time control objects

A communication object for enabling and disabling templates is available for each of the up to 16 templates in the colour control module. See chapter: [15.1.3 Disable/enable](#). These need to be enabled under time control in the DCA.

Object	Object name	Function	Type	Flags
68	Template 1, Activation	Activate/ Stop	1 Bit 1.010	CW
Template 1 is activated via this object. The template is active when the value is 1 and will be executed according to schedule.				
83	Template x, Activation	Activate/ Stop	1 Bit 1.010	CW
Template X is activated via this object. The template is active when the value is 1 and will be executed according to schedule.				

## 19.2 Broadcast objects

Object	Object name	Function	Type	Flags
3	Broadcast, Switching	On/Off	1 Bit 1.001	CW
<p>All connected lights can be switched on or off together using this object. If connected ECGs are in a special state (test mode, panic mode), they are not switched. In this case, switching takes place through sequential addressing on the DALI bus and a delay between the first and last luminaire may be visible. If there is no special state, switching takes place simultaneously using DALI broadcast telegrams. The broadcast switching function always switches to 0 or 100%. The parameters "switch-on and switch-off value" for groups and electronic ballasts are not taken into account.</p> <p><b>Note:</b> This object is only visible if you have selected <a href="#">Parameterpage-&gt; Special Function</a> "Enable broadcast" in the parameters.</p>				
4	Broadcast, Set Value	Value	1 Byte 5.001	CW
<p>All connected lights can be set to one value using this object. If connected ECGs are in a special condition (test mode, panic mode), they are not changed. In this case, switching takes place by sequential addressing on the DALI bus and a delay between the first and last light may be visible. If there is no special state, the values are set at the same time by DALI broadcast telegrams.</p> <p><b>Note:</b> This object is only visible if "Enable broadcast" was selected in the parameters <a href="#">Parameterpage -&gt; Special function</a>. Broadcast can also be released for colour control. In this case, up to 4 further objects no. 3-7 are shown, see <a href="#">Parameter page: -&gt; Special functions</a>. The description of the different colour control objects is explained in detail in chapter: <a href="#">3 Colour control</a>.</p>				

### 19.2.1 Broadcast objects colour control

Object	Object name	Function	Type	Flags
5	Broadcast, (RGB) Red	Value	1 Byte 5.001	CW
The broadcast colour control can be set via this object. The values for (RGB) red are transferred here.				
5a	Broadcast, (RGB)	Value	3 Byte 232.600	CW
Send the colour (RGB) via this object.				
5b	Broadcast, (HSV) Hue	Value	1 Byte 5.001	CW
Send the (HSV) Hue value via this object.				
5c	Broadcast, (RGBW)	Value	6 Byte 251.600	CW
The set colour (RGBW) is sent as a value via this object.				
5d	Broadcast, Set Colour X	Value	2 Bytes 7.600	CW
Send the (X/Y Colour) X value via this object.				
6	Broadcast, (RGB) Green	Value	1 Byte 5.001	CW
The broadcast colour control can be set via this object. The values for (RGB) green are transferred here.				
6a	Broadcast, (HSV) Saturation	Value	1 Byte 5.001	CW

Send the saturation via an HSV value via this object.				
6b	Broadcast, Set Colour Y	Value	2 Bytes 7.600	CW
Send the (X/Y Colour) Y value via this object.				
7	Broadcast, (RGB) Blue	Value	1 Byte 5.001	CW
The broadcast colour control can be set via this object. The values for (RGB) blue are transferred here.				
8	Broadcast, White	Value	1 Byte 5.001	CW
The broadcast control can be set via this object. The values for red white are transferred here.				
9	Broadcast, Colour Temperatur	Value	2 Bytes 7.600	CW
Send the colour temperatur value via this object.				

## 19.3 Group objects

A set of communication objects is available for each one of the up to 16 possible groups.  
The following objects are available (Example group 1):

### 19.3.1 Group objects behaviour

Object	Object name	Function	Type	Flags												
85	G1, Switching	On/ Off	1 Bit 1.001	CW												
Use this object to switch group 1 on or off.																
86	G1, Dimming	Brighter/Darker	4 Bit 3.007	CW												
Used for the relative dimming of group 1. Bit 4 is set to dim up and deleted to dim down. Bits 1 to 3 refer to the increment size. Bit 1 to 3 deleted is interpreted as a stop telegram.																
87	G1, Value setting	Value	1 Byte 5.001	CW												
Über dieses Object kann Gruppe 1 auf den entsprechenden Value gesetzt werden.																
88	G1, Value setting	Value/Time	3 Bytes 225.001	CW												
<p><b>Attention:</b> Object 50 is shown for the following parameter: G1 --&gt; Behaviour --&gt; Additional value setting object with dim time. Use this object to set group 1 to the required value and dim time.</p> <p><b>Format:</b> 3 octets: U<sub>16</sub>U<sub>8</sub></p> <table border="1"> <tr> <td>octet nr.</td> <td>3 MSB</td> <td>2</td> <td>1 LSB</td> </tr> <tr> <td>field names</td> <td>TimePeriod</td> <td colspan="2">Percent</td> </tr> <tr> <td>encoding</td> <td>UUUUUUUU</td> <td>UUUUUUUU</td> <td>UUUUUUUU</td> </tr> </table> <p>The time is defined in multiples of 100 ms. Because of Dali properties, a value range of 1s to 200s is accepted. Values outside this value range are restricted accordingly. A dim time of 10s is coded as follows: 10 s = 10x10x100 ms</p>					octet nr.	3 MSB	2	1 LSB	field names	TimePeriod	Percent		encoding	UUUUUUUU	UUUUUUUU	UUUUUUUU
octet nr.	3 MSB	2	1 LSB													
field names	TimePeriod	Percent														
encoding	UUUUUUUU	UUUUUUUU	UUUUUUUU													
89	G1, Enable	Yes/No	1 Bit 1.003	CW												
<p><b>Attention:</b> Object 51 is shown for the following parameter: G1 --&gt; General --&gt; Function of the additional object This object enables the operation of group 1: Object = 0 → Disabled Object = 1 → Enabled</p>																
89a	G1, Disable	Yes / no	1 Bit 1.003	CW												
This object disables the operation of group 1: Object = 0 → Enabled Object = 1 → Disabled																
90	G1, Status	On/Off	1 Bit 1.001	CRT												
Sends the switch status of the group. Any value >0% is interpreted as ON.																
91	G1, Status	Value	1 Byte 5.001	CRT												
Sends the value status of the group.																

## 19.3.2 Group objects colour control

Different colour control options are supported:

- **Colour temperature**
- **RGB**
- **HSV**
- **RGBW**
- **XY**
- **Colour temperature + RGB**
- **Colour temperature + RGBW**

Only one type of colour control can be selected per group. All ECGs in the group that support this type, can be controlled. Other ECG types will not react to the command. Please make sure to only include ECGs with the same colour control in a group. Depending on type of colour control chosen, different objects are displayed:

### 19.3.2.1 Colour temperature

The colour temperature can be set in Kelvin. Colour temperatures below 3000 K are called "warm white", above 5000 K "cool white" and between 3000 and 5000 "neutral white".

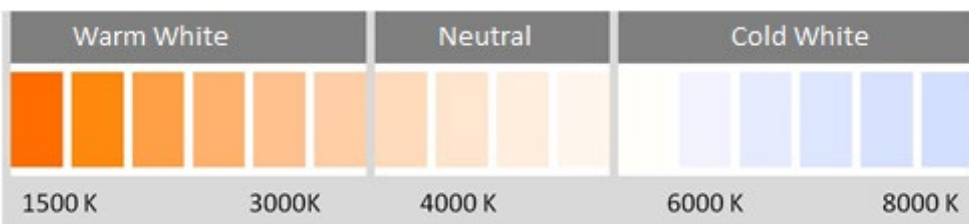

Object	Object name	Function	Type	Flags
96	G1, Colour temperature	Value	2 Byte 7.600	CW
Sets the colour temperature in the group.				
97	G1, Colour temperature relative	Value	1 Byte 5.001	CW
Sets the colour temperature in the group relatively between 0 and 100%. The value range 0 to 100% is automatically converted to the possible colour temperature range.				
102	G1, Colour Control Fading	Warmer/Cooler	4 Bit 3.007	CW
The colour in the group can be changed using this object. Increase the angle with bit 3 set, decrease the angle with bit 3 deleted. Bit 0..3 deleted is interpreted as a stop telegram. This means that the entire circumference of the circle can be circulated and every colour can be set.				

108	G1, Colour Temperature	Status	2 Byte 7.600	CRT
Sends the set colour temperature as group status.				
113	G1, Colour Temperature relative	Status	1 Byte 5.001	CRT
Sends the set relative colour temperature as group status.				

### 19.3.2.2 RGB

The RGB colour space is called additive colour space as the colour perception is created by mixing the three primary colours.

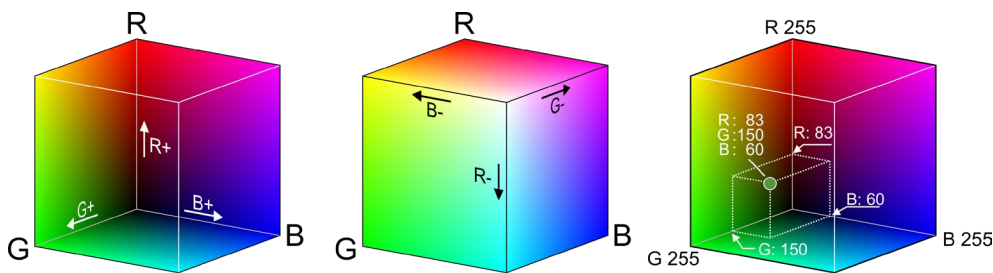

Figure 3: RGB cubes (source: Wikipedia)

#### 19.3.2.2.1 RGB (DPT 232.600)

Object	Object name	Function	Type	Flags																																																		
95	G1, Colour RGB	Value	3 Byte 232.600	CW																																																		
Sets the colour in the group as RGB.																																																						
<table border="1"> <tr> <td><b>Format:</b></td> <td colspan="3">3 octets: U<sub>s</sub>U<sub>s</sub>U<sub>s</sub></td> </tr> <tr> <td>octet nr.</td> <td>3 MSB</td> <td>2</td> <td>1 LSB</td> </tr> <tr> <td>field names</td> <td>R</td> <td>G</td> <td>B</td> </tr> <tr> <td>encoding</td> <td>UUUUUUUU</td> <td>UUUUUUUU</td> <td>UUUUUUUU</td> </tr> <tr> <td><b>Encoding:</b></td> <td colspan="3">All values binary encoded.</td> </tr> <tr> <td><b>Range:</b></td> <td colspan="3">R, G, B: 0 to 255</td> </tr> <tr> <td><b>Unit:</b></td> <td colspan="3">None</td> </tr> <tr> <td><b>Resol.:</b></td> <td colspan="3">1</td> </tr> <tr> <td><b>PDT:</b></td> <td colspan="3">PDT_GENERIC_03</td> </tr> <tr> <td colspan="4"><b>Datapoint Types</b></td> </tr> <tr> <td><b>ID:</b></td> <td><b>Name:</b></td> <td><b>Range:</b></td> <td><b>Resol.:</b></td> <td><b>Use:</b></td> </tr> <tr> <td>232.600</td> <td>DPT_Colour_RGB</td> <td>R: 0 to 255 G: 0 to 255 B: 0 to 255</td> <td>R: 1 G: 1 B: 1</td> <td>G</td> </tr> </table>					<b>Format:</b>	3 octets: U <sub>s</sub> U <sub>s</sub> U <sub>s</sub>			octet nr.	3 MSB	2	1 LSB	field names	R	G	B	encoding	UUUUUUUU	UUUUUUUU	UUUUUUUU	<b>Encoding:</b>	All values binary encoded.			<b>Range:</b>	R, G, B: 0 to 255			<b>Unit:</b>	None			<b>Resol.:</b>	1			<b>PDT:</b>	PDT_GENERIC_03			<b>Datapoint Types</b>				<b>ID:</b>	<b>Name:</b>	<b>Range:</b>	<b>Resol.:</b>	<b>Use:</b>	232.600	DPT_Colour_RGB	R: 0 to 255 G: 0 to 255 B: 0 to 255	R: 1 G: 1 B: 1	G
<b>Format:</b>	3 octets: U <sub>s</sub> U <sub>s</sub> U <sub>s</sub>																																																					
octet nr.	3 MSB	2	1 LSB																																																			
field names	R	G	B																																																			
encoding	UUUUUUUU	UUUUUUUU	UUUUUUUU																																																			
<b>Encoding:</b>	All values binary encoded.																																																					
<b>Range:</b>	R, G, B: 0 to 255																																																					
<b>Unit:</b>	None																																																					
<b>Resol.:</b>	1																																																					
<b>PDT:</b>	PDT_GENERIC_03																																																					
<b>Datapoint Types</b>																																																						
<b>ID:</b>	<b>Name:</b>	<b>Range:</b>	<b>Resol.:</b>	<b>Use:</b>																																																		
232.600	DPT_Colour_RGB	R: 0 to 255 G: 0 to 255 B: 0 to 255	R: 1 G: 1 B: 1	G																																																		
107	G1, Colour RGB	Status	3 Byte 232.600	CRT																																																		
Use this object to send the set colour of the group as status.																																																						

#### 19.3.2.2.2 RGB (separate objects)

Object	Object name	Function	Type	Flags
98	G1, Colour (RGB) Red	Value	1 Byte 5.001	CW

Sets the colour in the group. The values for red (R) are transmitted.				
99	G1, Colour (RGB) Green	Value	1 Byte 5.001	CW
Sets the colour in the group. The values for green (G) are transmitted.				
100	G1, Colour (RGB) Blue	Value	1 Byte 5.001	CW
Sets the colour in the group. The values for blue (B) are transmitted..				
103	G1, (RGB) Fading Red	Brighter/Darker	4 Bit 3.007	CW
Use this object to change the colour (R) in the group. Bit 4 is set to increase the red component and deleted to decrease the red component. Bits 1 to 3 refer to the increment size. Bit 1 to 3 deleted is interpreted as a stop telegram.				
104	G1, (RGB) Fading Green	Brighter/Darker	4 Bit 3.007	CW
Use this object to change the colour (G) in the group. Description as for colour change RGB (R).				
105	G1, (RGB) Fading Blue	Brighter/Darker	4 Bit 3.007	CW
Use this object to change the colour (B) in the group. Description as for colour change RGB (R).				
109	G1, Colour (RGB) Red	Status	1 Byte 5.001	CRT
Sends the selected colour (R) as group status.				
110	G1, Colour (RGB) Green	Status	1 Byte 5.001	CRT
Sends the selected colour (G) as group status.				
111	G1, Colour (RGB) Blue	Status	1 Byte 5.001	CRT
Sends the selected colour (B) as group status.				

### 19.3.2.3 HSV

The colour is set as an HSV value. This consists of hue, saturation and value. The value (V) is set via the value object number 60/61. Further objects are displayed for hue (H) and saturation (S). The hue is entered as a value between 0° and 360° and rotates around the colour circle making it easy to reach all colours of the circle.

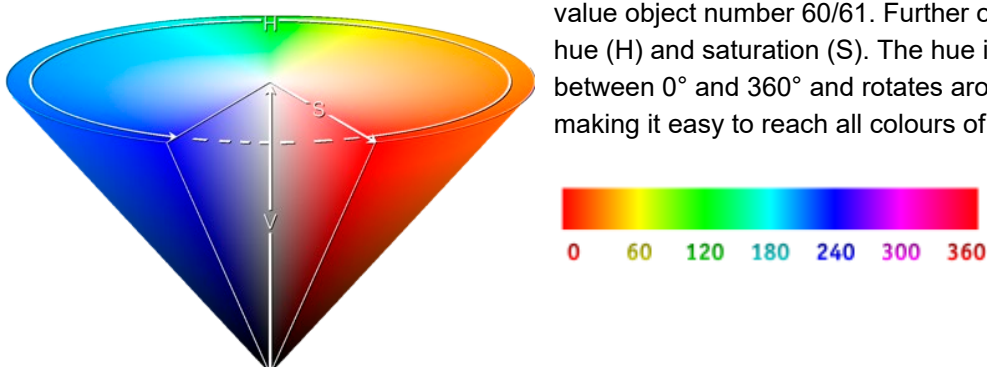
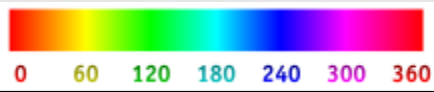

Figure 4: HSV colour value (Source: Wikipedia)

Values for saturation and intensity (darkness value) are set between 0 and 100%. 100% mean complete saturation and full intensity.

### 19.3.2.3.1 HSV (separate objects)

Object	Object name	Function	Type	Flags
98	G1, Colour (HSV) Hue	Value	1 Byte 5.003	CW
<p>Sets the colour via an HSV value. A value between 0° and 360° can be transmitted. Please remember that the used data type 5.003 only allows for a resolution of about 1.4°.</p> 				
99	G1, Colour (HSV) Saturation	Value	1 Byte 5.001	CW
<p>Use this object to set the saturation. A value between 0° and 100% can be transmitted.</p>				
103	G1, Colour (HSV) Fading Hue	Brighter/Darker	4 Bit 3.007	CW
<p>Use this object to change the hue of a group. Bit 3 is set to increase the angle and deleted to decrease the angle. Bit 1 to 3 deleted is interpreted as a stop telegram. As the whole colour circle is accessible, any colour can be set.</p>				
104	G1, Colour (HSV) Fading Saturation	Brighter/Darker	4 Bit 3.007	CW
<p>See change of hue above. The value between 0 and 100% is increased incrementally.</p>				
109	G1, Colour (HSV) Hue	Status	1 Byte 5.003	CRT
<p>Sends the configured hue as group status.</p>				
110	G1, Colour (HSV) Saturation	Status	1 Byte 5.001	CRT
<p>Sends the configured saturation as group status.</p>				

### 19.3.2.4 RGBW

#### 19.3.2.4.1 RGBW (6 Byte object Object DPT 251.600)

Object	Object name	Function	Type	Flags
95	G1, Colour RGBW	Value	6 Byte 251.600	CW
<p>Use this object to set the colour in the group as RGBW. Enter the colour values for white, blue, green and red between 0 and 100% in the upper Bytes. 4 Bits in the 1st Byte determine whether the corresponding colour values are valid.</p>				

MTN6725-0101

Datapoint Type					
DPT Name:		DPT Colour RGBW			
DPT Format:		U <sub>8</sub> U <sub>8</sub> U <sub>8</sub> U <sub>8</sub> r <sub>4</sub> B <sub>4</sub>		DPT ID:	251.600
Field	Description	Supp.	Range	Unit	Default
R	Colour Level Red	M	0 % to 100 %	-	-
G	Colour Level Green	M	0 % to 100 %	-	-
B	Colour Level Blue	M	0 % to 100 %	-	-
W	Colour Level White	M	0 % to 100 %	-	-
m <sub>R</sub>	Shall specify whether the colour information red in the field R is valid or not.	M	{0,1}	None.	None.
m <sub>G</sub>	Shall specify whether the colour information green in the field G is valid or not.	M	{0,1}	None.	None.
m <sub>B</sub>	Shall specify whether the colour information blue in the field B is valid or not.	M	{0,1}	None.	None.
m <sub>W</sub>	Shall specify whether the colour information white in the field W is valid or not.	M	{0,1}	None.	None.

107	G1, Colour RGBW	Status	6 Byte 251.600	CRT
-----	-----------------	--------	-------------------	-----

Sends the set colour of the group as status.

#### 19.3.2.4.2 RGBW (seperate Objects)

Object	Object name	Function	Type	Flags
98	G1, Colour (RGB) Red	Value	1 Byte 5.001	CW
Sets the colour in the group. The values for red (R) are transmitted.				
99	G1, Colour (RGB) Green	Value	1 Byte 5.001	CW
Sets the colour in the group. The values for green (G) are transmitted.				
100	G1, Colour (RGB) Blue	Value	1 Byte 5.001	CW
Sets the colour in the group. The values for blue (B) are transmitted.				
101	G1, Colour White	Value	1 Byte 5.001	CW
Sets the colour in the group. The values for white (W) are transmitted.				
103	G1, (RGB) Fading Red	Brighter/Darker	4 Bit 3.007	CW
Use this object to change the colour (R) in the group. Bit 4 is set to increase the red component and deleted to decrease the red component. Bits 1 to 3 refer to the increment size. Bit 1 to 3 deleted is interpreted as a stop telegram.				
104	G1, (RGB) Fading Green	Brighter/Darker	4 Bit 3.007	CW
Use this object to change the colour (G) in the group. Description as for colour change (red).				
105	G1, (RGB) Fading Blue	Brighter/Darker	4 Bit 3.007	CW
Use this object to change the colour (B) in the group. Description as for colour change (red).				
106	G1, Fading White	Brighter/Darker	4 Bit 3.007	CW
Use this object to change the colour green in the group. Description as for colour change (red).				

109	G1, Colour (RGB) Red	Status	1 Byte 5.001	CRT
Sends the set colour red as group status.				
110	G1, Colour (RGB) Green	Status	1 Byte 5.001	CRT
Sends the set colour green as group status.				
111	G1, Colour (RGB) Blue	Status	1 Byte 5.001	CRT
Sends the set colour blue as group status.				
112	G1, Colour White	Status	1 Byte 5.001	CRT
Sends the set colour white as group status.				

### 19.3.2.5 HSVW (separate Objects)

See chapter: [19.3.2.3.1 HSV \(separate objects\)](#)

### 19.3.2.6 XY Colour

The colour is determined through an XY value between 0 and 1:

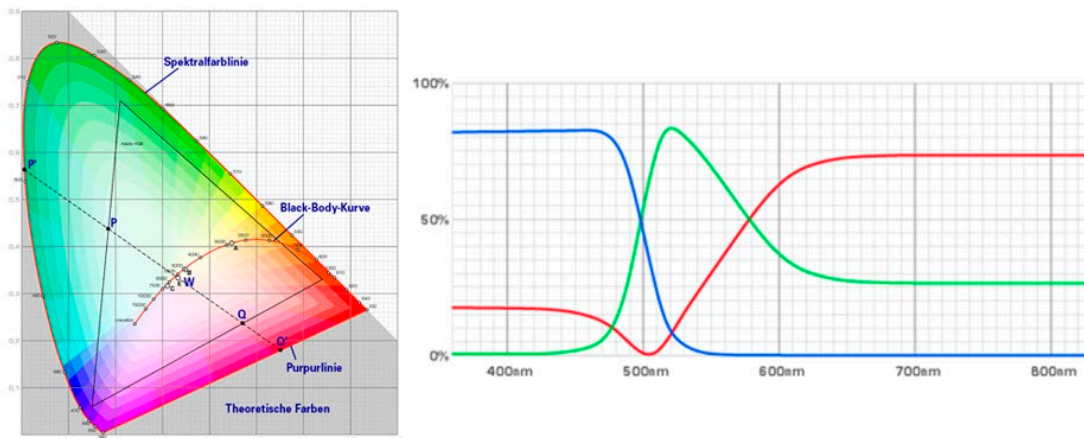

Figure 5: XY colour value (Source: Wikipedia)

Im KNX wird dieser Valueebereich auf einen Bereich 0..65535 (2 Byte Ganzzahl) umgerechnet. Der Value 65535 entspricht daher dem Value 1 in der Grafik.

#### 19.3.2.6.1 XY (combined objects)

Object	Object name	Function	Type	Flags
95	G1, Colour XY	Value	6 Byte 242.600	CW
Use this object to set the colour via XY coordinates in the group. The brightness level is entered in the 2nd Byte via a value between 0 and 100% followed by the Y and X coordinates between 0 and 65535. 2 Bit in the lower byte determine whether brightness and XY values are valid.				

MTN6725-0101

Datapoint Types				
ID:	Name:	Use:		
242.600	DPT_Colour_xyY	FB		
Data fields	Description	Range	Unit	Resol.
x-axis	x-coordinate of the colour information	0 to 65 535	None.	None.
y-axis	y-coordinate of the colour information	0 to 65 535	None.	None.
Additional encoding information				
The x – and y – ordinate of the xyY colour scheme have a value between 0 and 1. This value shall be linearly mapped onto the range from 0 to 65 535, by multiplying the unencoded coordinate value by 65 535 and rounding to the earest integer value. For decoding, the inverse operation shall be done.				
Brightness	Brightness of the colour	0 % to 100 %	%	None.
Additional encoding information				
The brightness shall be encoded as in DPT_Scaling (5.001).				
C	This field shall indicate whether the colour information in the fields x-axis and y-axis is valid or not.	0: invalid 1: valid	None.	None.
B	This field shall indicate whether the Brightness information in the field Brightness is valid or not.	0: invalid 1: valid	None.	None.
107	G1, Colour XY	Status	6 Byte 242.600	CRT
This object is used to send the set XY coordinates as status of the group.				

### 19.3.2.6.2 XY (separate objects)

Obj	Object name	Function	Type	Flags
95	G1, Colour X	Value	2 Byte 7.001	CW
Use this object to set the X value between 0 and 65535.				
98	G1, Colour Y	Value	2 Byte 7.001	CW
Use this object to set the Y value between 0 and 65535.				
107	G1, Colour X	Status	2 Byte 7.001	CRT
Use this object to set the X value between 0 and 65535.				
109	G1, Colour Y	Status	2 Byte 7.001	CRT
Use this object to set the Y value between 0 and 65535.				

### 19.3.2.7 Colour temperature + RGB

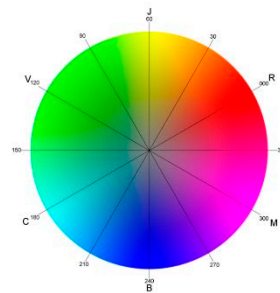
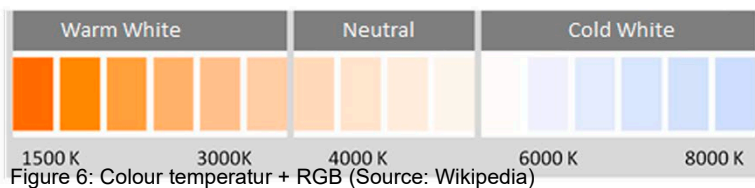

#### 19.3.2.7.1 Colour temperature + RGB (3 Byte combined Objects DPT 232.600)

Object	Object name	Function	Type	Flags
95	G1, Colour RGB	Value	3 Byte 232.600	CW
The colour can be set as RGB in the group via this object. The colour values for white, blue, green and red are given in the lower bytes in the value range of 0 ... 100%. In the 5th byte, 4 bits indicate whether the corresponding colour values are valid.				
96	G1, Colour temperature	Value	2 Byte 7.600	CW
Sets the colour temperature in the group.				
97	G1, Colour temperature relative	Value	1 Byte 5.001	CW
Sets the colour temperature in the group relatively between 0 and 100%. The value range 0 to 100% is automatically converted to the possible colour temperature range.				
102	G1, Colour Control Fading	Warmer/Colder	4 Bit 3.007	CW
Changes the colour temperature in the group. Bit 4 is set to dim up and deleted to dim down. Bits 1 to 3 refer to the increment size. Bit 1 to 3 deleted is interpreted as a stop telegram.				

107	G1, Colour RGB	Status	3 Byte 232.600	CRT
Sends the set RGB colour as group status.				
108	G1, Colour temperature	Status	2 Byte 7.600	CRT
Sends the set colour temperature as group status.				
113	G1, Colour temperature relative	Status	1 Byte 5.001	CRT
Sends the set relative colour temperature as group status.				

### 19.3.2.7.2 Colour temperature + RGB (RGB separate objects)

Object	Object name	Function	Type	Flags
96	G1, Colour temperature	Value	2 Byte 7.600	CW
Sets the colour temperature in the group.				
97	G1, Colour temperature relative	Value	1 Byte 5.001	CW
Sets the colour temperature in the group relatively between 0 and 100%. The value range 0 to 100% is automatically converted to the possible colour temperature range.				
98	G1, Colour (RGB Red)	Value	1 Byte 5.001	CW
Sets the colour in the group. The values for red (R) are transmitted.				
99	G1, Colour (RGB Green)	Value	1 Byte 5.001	CW
Sets the colour in the group. The values for green (G) are transmitted.				
100	G1, Colour (RGB Blue)	Value	1 Byte 5.001	CW
Sets the colour in the group. The values for blue (B) are transmitted.				
102	G1, Colour Control Fading	Value	1 Byte 5.001	CW
Changes the colour temperature in the group. Bit 4 is set to dim up and deleted to dim down. Bits 1 to 3 refer to the increment size. Bit 1 to 3 deleted is interpreted as a stop telegram.				
103	G1, Colour (RGB) Fading Red	Brighter/Darker	4 Bit 3.007	CW
Use this object to change the colour red in the group. Bit 4 is set to increase the red component and deleted to decrease the red component. Bits 1 to 3 refer to the increment size. Bit 1 to 3 deleted is interpreted as a stop telegram.				
104	G1, Colour (RGB) Fading Green	Brighter/Darker	4 Bit 3.007	CW
Use this object to change the colour green in the group. Description as for colour change (red).				
105	G1, Colour (RGB) Fading Blue	Brighter/Darker	4 Bit 3.007	CW
Use this object to change the colour blue in the group. Description as for colour change (red).				
108	G1, Colour temperature	Status	2 Byte 7.600	CRT

Sends the set colour temperature as group status.				
109	G1, Colour (RGB Red)	Status	1 Byte 5.001	CRT
Sends the set colour red as group status.				
110	G1, Colour (RGB Green)	Status	1 Byte 5.001	CRT
Sends the set colour green as group status.				
111	G1, Colour (RGB Blue)	Status	1 Byte 5.001	CRT
Sends the set colour blue as group status.				
113	G1, Colour temperature relative	Status	1 Byte 5.001	CRT
Sends the set relative colour temperature as group status.				

### 19.3.2.7.3 Colour temperature + RGB (HSV separate objects)

Object	Object name	Function	Type	Flags
96	G1, Colour temperature	Value	2 Byte 7.600	CW
Sets the colour temperature in the group.				
97	G1, Colour temperature relative	Value	1 Byte 5.001	CW
Sets the colour temperature in the group relatively between 0 and 100%. The value range 0 to 100% is automatically converted to the possible colour temperature range.				
98	G1, Colour (HSV) Hue	Value	1 Byte 5.003	CW
Sets the colour via an HSV value. A value between 0° and 360° can be transmitted. Please remember that the used data type 5.003 only allows for a resolution of about 1.4°.				
				
99	G1, Colour (HSV) Saturation	Value	1 Byte 5.001	CW
Use this object to set the saturation. A value between 0° and 100% can be transmitted.				
102	G1, Colour Control Fading	Warmer/Cooler	4 Bit 3.007	CW
The colour in the group can be changed using this object. Increase the angle with bit 3 set, decrease the angle with bit 3 deleted. Bit 0..3 deleted is interpreted as a stop telegram. This means that the entire circumference of the circle can be circulated and every colour can be set.				
103	G1, Colour Control Fading Hue	Brighter/Darker	4 Bit 3.007	CW
Use this object to change the hue of a group. Bit 3 is set to increase the angle and deleted to decrease the angle. Bit 1 to 3 deleted is interpreted as a stop telegram. As the whole colour circle is accessible, any colour can be set.				

104	G1, Colour Control Fading Saturation	Brighter/Darker	4 Bit 3.007	CW
See change of hue above. The value between 0 and 100% is increased incrementally				
108	G1, Colour temperature	Status	2 Byte 7.600	CRT
Sends the set colour temperature as group status				
109	G1, Colour (HSV) Hue	Status	1 Byte 5.003	CRT
Sends the configured hue as group status.				
110	G1, Colour (HSV) Saturation	Status	1 Byte 5.003	CRT
Sends the configured saturation as group status.				
113	G1, Colour temperature relative	Status	1 Byte 5.001	CRT
Sends the set relative colour temperature as group status.				

### 19.3.2.8 Colour temperature + RGBW

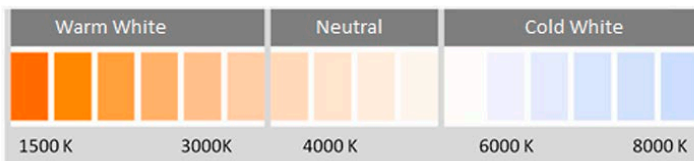

#### 19.3.2.8.1 Colour temperature + RGBW (6 Byte combined Objects DPT 251.600)

Object	Object name	Function	Type	Flags
95	G1, Colour RGBW	Value	6 Byte 251.600	CW
The colour can be set as RGB in the group via this object. The colour values for white, blue, green and red are given in the lower bytes in the value range of 0 ... 100%. In the 5th byte, 4 bits indicate whether the corresponding colour values are valid.				
96	G1, Colour temperature	Value	2 Byte 7.600	CW
Sets the colour temperature in the group.				
97	G1, Colour temperature relative	Value	1 Byte 5.001	CW
Sets the colour temperature in the group relatively between 0 and 100%. The value range 0 to 100% is automatically converted to the possible colour temperature range.				
102	G1, Colour Control Fading	Warmer/Colder	4 Bit 3.007	CW
Changes the colour temperature in the group. Bit 4 is set to dim up and deleted to dim down. Bits 1 to 3 refer to the increment size. Bit 1 to 3 deleted is interpreted as a stop telegram.				
107	G1, Colour RGBW	Status	6 Byte 251.600	CRT
Sends the set RGB colour as group status.				
108	G1, Colour temperature	Status	2 Byte 7.600	CRT
Sends the set colour temperature as group status.				

113	G1, Colour temperature relative	Status	1 Byte 5.001	CRT
Sends the set relative colour temperature as group status.				

### 19.3.2.8.2 Colour temperature + RGBW (RGBW separate objects)

Object	Object name	Function	Type	Flags
96	G1, Colour temperature	Value	2 Byte 7.600	CW
Sets the colour temperature in the group.				
97	G1, Colour temperature relative	Value	1 Byte 5.001	CW
Sets the colour temperature in the group relatively between 0 and 100%. The value range 0 to 100% is automatically converted to the possible colour temperature range.				
98	G1, Colour (RGB Red)	Value	1 Byte 5.001	CW
Sets the colour in the group. The values for red (R) are transmitted.				
99	G1, Colour (RGB Green)	Value	1 Byte 5.001	CW
Sets the colour in the group. The values for green (G) are transmitted.				
100	G1, Colour (RGB Blue)	Value	1 Byte 5.001	CW
Sets the colour in the group. The values for blue (B) are transmitted.				
101	G1, Colour White	Value	1 Byte 5.001	CW
Sets the colour in the group. The values for white (W) are transmitted.				
102	G1, Colour Control Fading	Warmer/Colder	4 Bit 3.007	CW
Changes the colour temperature in the group. Bit 4 is set to dim up and deleted to dim down. Bits 1 to 3 refer to the increment size. Bit 1 to 3 deleted is interpreted as a stop telegram.				
103	G1, Colour (RGB) Fading Red	Brighter/Darker	4 Bit 3.007	CW
Use this object to change the colour red in the group. Bit 4 is set to increase the red component and deleted to decrease the red component. Bits 1 to 3 refer to the increment size. Bit 1 to 3 deleted is interpreted as a stop telegram.				
104	G1, Colour (RGB) Fading Green	Brighter/Darker	4 Bit 3.007	CW
Use this object to change the colour green in the group. Description as for colour change (red).				
105	G1, Colour (RGB) Fading Blue	Brighter/Darker	4 Bit 3.007	CW
Use this object to change the colour blue in the group. Description as for colour change (red).				
106	G1, Colour Fading White	Brighter/Darker	4 Bit 3.007	CW
Use this object to change white in the group. Description as for colour change (red).				
108	G1, Colour temperature	Status	2 Byte 7.600	CRT

Sends the set colour temperature as group status.				
109	G1, Colour (RGB Red)	Status	1 Byte 5.001	CRT
Sends the set colour red as group status.				
110	G1, Colour (RGB Green)	Status	1 Byte 5.001	CRT
Sends the set colour green as group status.				
111	G1, Colour (RGB Blue)	Status	1 Byte 5.001	CRT
Sends the set colour blue as group status.				
112	G1, Colour White	Status	1 Byte 5.001	CRT
Sends the set white as group status.				
113	G1, Colour temperature relative	Status	1 Byte 5.001	CRT
Sends the set relative colour temperature as group status.				

### 19.3.2.8.3 Colour temperature + RGBW (HSVW separate objects)

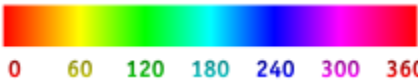
Object	Object name	Function	Type	Flags
96	G1, Colour temperature	Value	2 Byte 7.600	CW
Sets the colour temperature in the group.				
97	G1, Colour temperature relative	Value	1 Byte 5.001	CW
Sets the colour temperature in the group relatively between 0 and 100%. The value range 0 to 100% is automatically converted to the possible colour temperature range.				
98	G1, Colour (HSV) Hue	Value	1 Byte 5.003	CW
Sets the colour via an HSV value. A value between 0° and 360° can be transmitted. Please remember that the used data type 5.003 only allows for a resolution of about 1.4°.				
				

MTN6725-0101

99	G1, Colour (HSV) Saturation	Value	1 Byte 5.001	CW
Use this object to set the saturation. A value between 0° and 100% can be transmitted.				
101	G1, Colour White	Value	1 Byte 5.001	CW
Sets the colour in the group. The values for white (W) are transmitted.				
102	G1, Colour Control Fading	Warmer/Cooler	4 Bit 3.007	CW
The colour in the group can be changed using this object. Increase the angle with bit 3 set, decrease the angle with bit 3 deleted. Bit 0..3 deleted is interpreted as a stop telegram. This means that the entire circumference of the circle can be circulated and every colour can be set.				
103	G1, Colour Control Fading Hue	Brighter/Darker	4 Bit 3.007	CW
Use this object to change the hue of a group. Bit 3 is set to increase the angle and deleted to decrease the angle. Bit 1 to 3 deleted is interpreted as a stop telegram. As the whole colour circle is accessible, any colour can be set.				
104	G1, Colour Control Fading Saturation	Brighter/Darker	4 Bit 3.007	CW
See change of hue above. The value between 0 and 100% is increased incrementally				
106	G1, Colour Fading White	Brighter/Darker	4 Bit 3.007	CW
Use this object to change white in the group. Description as for colour change (red).				
108	G1, Colour temperature	Status	2 Byte 7.600	CRT
Sends the set colour temperature as group status				
109	G1, Colour (HSV) Hue	Status	1 Byte 5.003	CRT
Sends the configured hue as group status.				
110	G1, Colour (HSV) Saturation	Status	1 Byte 5.003	CRT
Sends the configured saturation as group status.				
112	G1, Colour White	Status	1 Byte 5.003	CRT
Sends the set white as group status.				
113	G1, Colour temperature relative	Status	1 Byte 5.001	CRT
Sends the set relative colour temperature as group status.				

### 19.3.3 Group objects analysis and service

Object	Object name	Function	Type	Flags
92	G1, Failure Status	Yes/No	1 Bit 1.001	CRT
<b>Attention:</b> Object 92 is shown for the following parameter: <u>G1 --&gt; Analysis and service--&gt;</u> "Type of failure status object". This object is used to send the failure status for lamp, ECG and converter failures within the group.				
94	G1, Failure Exceeds Theshold	Yes/No	1 Bit	CRT
This object is used to report that the total of all lamp failures recognised in the DALI segment exceeds the set threshold.				
94a	G1, Failure Theshold in Total	Value	1 Byte 5.010	CRT
This object is used to report the failure rate in total of the total number of lamps in the DALI segment.				
94b	G1, Failure Theshold in %	Value	1 Byte 5.001	CRT
Alternatively, this object is used to report the failure rate as a percentage of the total number of lamps in the DALI segment.				
114	G1, Operating Hours Reset	Yes/No	1 Bit 1.015	CW
Resets the operating hours in a group via value "1". <b>Note:</b> Object 76-78 is shown for the following parameter: <u>G1 --&gt; Analysis and service --&gt;</u> "Operation Hour Calculation" = Yes.				
115	G1, Operating Hours (Seconds)	Value	4 Byte 13.100	CW
Counts the operating hours in the group. The value is transmitted in seconds according to DPT 13.100.				
115a	G1, Operating Hours (Hours)	Value	4 Byte 12.102	CW
Counts the operating hours in the group. The value is transmitted in hours according to DPT 12.102.				
116	G1, Life Time Exceeded	Yes/No	1 Bit 1.005	CW
Shows whether the maximum life span set in the parameters has been exceeded. <b>Note:</b> If the threshold value is exceeded, an alarm is sent via this object (by sending the value "1"). An alarm is re-sent for every operating hour that is above the threshold value.				
117	G1, Active Power	Value	4 Byte 14.056	CRT
This object provides the total active power of all ECGs of device type 51 according to DALI part 252 which are assigned in this group.				
117a	G1, Active Energy	Value	4 Byte 13.010	CRT
This object provides the total active energy of all ECGs of device type 51 according to DALI part 252 which are assigned in this group.				

## 19.4 Single ECG objects

### 19.4.1 Single ECG objects behaviour

A communication object is available for each of the up to 64 connected ECGs and corresponding lamps to display the failure status. (Example ECG 1):

Object	Object name	Function	Type	Flags
629	ECG1, Switching	On/Off	1 Bit 1.001	CW

Use this object to switch an ECG on or off if it is not in special mode (test mode, emergency lights, panic/ emergency mode).				
630	ECG1, Dimming	Brighter/Darker	4 Bit 3.007	CW
This object is used for the relative dimming of an ECG that is not in special mode (test mode, emergency lights, panic/ emergency mode). Bit 4 is set to dim up and deleted to dim down. Bits 1 to 3 refer to the increment size. Bit 1 to 3 deleted is interpreted as a stop telegram.				
631	ECG 1, Set Value	Value	1 Byte 5.001	CW
Sets the value of ECG1 unless it is in special mode (test mode, emergency lights, panic/ emergency mode).				
632	ECG1, Enable	Yes/No	1 Bit 1.003	CW
<b>Note:</b> Object 562 is shown for the following parameter: ECG 1 -->General -->Function of the additional object. Use this object to enable the operation of ECG 1: Object = 0 → Operation disabled Object = 1 → Enable operation				
632a	ECG1, Disable	Yes/No	1 Bit 1.003	CW
Use this object to disable the operation of ECG 1: Object = 0 → Enable operation Object = 1 → Operation disabled				
633	ECG1, Status	On/Off	1 Bit 1.001	CRT
Sends the ECG switch status. Each value >0% is interpreted as ON.				
634	ECG 1, Status	Value	1 Byte 5.001	CRT
Sends the ECG value status.				

### 19.4.2 Single ECG objects colour control

Objekt	Objekname	Funktion	Typ	Flags																																																		
636	ECG 1, Colour temperature	Value	2 Bytes 7.600	CW																																																		
Sets the ECG 1 colour temperature.																																																						
636a	ECG 1, Colour RGB	Value	3 Bytes 232.600	CW																																																		
Sets the ECG1 colour in as RGB.																																																						
<table border="1"> <tr> <td><b>Format:</b></td> <td colspan="3">3 octets: U<sub>8</sub>U<sub>8</sub>U<sub>8</sub></td> </tr> <tr> <td>octet nr.</td> <td>3 MSB</td> <td>2</td> <td>1 LSB</td> </tr> <tr> <td>field names</td> <td>R</td> <td>G</td> <td>B</td> </tr> <tr> <td>encoding</td> <td>UUUUUUUU</td> <td>UUUUUUUU</td> <td>UUUUUUUU</td> </tr> <tr> <td><b>Encoding:</b></td> <td colspan="3">All values binary encoded.</td> </tr> <tr> <td><b>Range:</b></td> <td colspan="3">R, G, B: 0 to 255</td> </tr> <tr> <td><b>Unit:</b></td> <td colspan="3">None</td> </tr> <tr> <td><b>Resol.:</b></td> <td colspan="3">1</td> </tr> <tr> <td><b>PDT:</b></td> <td colspan="3">PDT_GENERIC_03</td> </tr> <tr> <td colspan="4"><b>Datapoint Types</b></td> </tr> <tr> <td><b>ID:</b></td> <td><b>Name:</b></td> <td><b>Range:</b></td> <td><b>Resol.:</b></td> <td><b>Use:</b></td> </tr> <tr> <td>232.600</td> <td>DPT_Colour_RGB</td> <td>R: 0 to 255 G: 0 to 255 B: 0 to 255</td> <td>R: 1 G: 1 B: 1</td> <td>G</td> </tr> </table>					<b>Format:</b>	3 octets: U <sub>8</sub> U <sub>8</sub> U <sub>8</sub>			octet nr.	3 MSB	2	1 LSB	field names	R	G	B	encoding	UUUUUUUU	UUUUUUUU	UUUUUUUU	<b>Encoding:</b>	All values binary encoded.			<b>Range:</b>	R, G, B: 0 to 255			<b>Unit:</b>	None			<b>Resol.:</b>	1			<b>PDT:</b>	PDT_GENERIC_03			<b>Datapoint Types</b>				<b>ID:</b>	<b>Name:</b>	<b>Range:</b>	<b>Resol.:</b>	<b>Use:</b>	232.600	DPT_Colour_RGB	R: 0 to 255 G: 0 to 255 B: 0 to 255	R: 1 G: 1 B: 1	G
<b>Format:</b>	3 octets: U <sub>8</sub> U <sub>8</sub> U <sub>8</sub>																																																					
octet nr.	3 MSB	2	1 LSB																																																			
field names	R	G	B																																																			
encoding	UUUUUUUU	UUUUUUUU	UUUUUUUU																																																			
<b>Encoding:</b>	All values binary encoded.																																																					
<b>Range:</b>	R, G, B: 0 to 255																																																					
<b>Unit:</b>	None																																																					
<b>Resol.:</b>	1																																																					
<b>PDT:</b>	PDT_GENERIC_03																																																					
<b>Datapoint Types</b>																																																						
<b>ID:</b>	<b>Name:</b>	<b>Range:</b>	<b>Resol.:</b>	<b>Use:</b>																																																		
232.600	DPT_Colour_RGB	R: 0 to 255 G: 0 to 255 B: 0 to 255	R: 1 G: 1 B: 1	G																																																		
636b	ECG 1, Colour RGBW	Value	6 Bytes 251.600	CW																																																		

MTN6725-0101

Use this object to set the ECG1 colour as RGBW. Enter the colour values for white, blue, green and red between 0 and 100% in the upper Bytes. 4 Bits in the 1st Byte determine whether the corresponding colour values are valid.

Datapoint Type					
DPT Name:		DPT_Colour_RGBW			
DPT Format:		U <sub>8</sub> U <sub>8</sub> U <sub>8</sub> U <sub>8</sub> r <sub>4</sub> B <sub>4</sub>		DPT ID:	251.600
Field	Description	Supp.	Range	Unit	Default
R	Colour Level Red	M	0 % to 100 %	-	-
G	Colour Level Green	M	0 % to 100 %	-	-
B	Colour Level Blue	M	0 % to 100 %	-	-
W	Colour Level White	M	0 % to 100 %	-	-
m <sub>R</sub>	Shall specify whether the colour information red in the field R is valid or not.	M	{0,1}	None.	None.
m <sub>G</sub>	Shall specify whether the colour information green in the field G is valid or not.	M	{0,1}	None.	None.
m <sub>B</sub>	Shall specify whether the colour information blue in the field B is valid or not.	M	{0,1}	None.	None.
m <sub>W</sub>	Shall specify whether the colour information white in the field W is valid or not.	M	{0,1}	None.	None.

636c	ECG 1, Colour XY	Value	6 Bytes 242.600	CW
------	------------------	-------	--------------------	----

Use this object to set the colour via XY coordinates in the group. The brightness level is entered in the 2nd Byte via a value between 0 and 100% followed by the Y and X coordinates between 0 and 65535. 2 Bit in the lower byte determine whether brightness and XY values are valid.

Datapoint Types				
ID:	Name:	Use:		
242.600	DPT_Colour_xyY	FB		
Data fields	Description	Range	Unit	Resol.
x-axis	x-coordinate of the colour information	0 to 65 535	None.	None.
y-axis	y-coordinate of the colour information	0 to 65 535	None.	None.
<b>Additional encoding information</b>				
The x – and y – ordinate of the xyY colour scheme have a value between 0 and 1. This value shall be linearly mapped onto the range from 0 to 65 535, by multiplying the unencoded coordinate value by 65 535 and rounding to the nearest integer value. For decoding, the inverse operation shall be done.				
Brightness	Brightness of the colour	0 % to 100 %	%	None.
<b>Additional encoding information</b>				
The brightness shall be encoded as in DPT_Scaling (5.001).				
C	This field shall indicate whether the colour information in the fields x-axis and y-axis is valid or not.	0: invalid 1: valid	None.	None.
B	This field shall indicate whether the Brightness information in the field Brightness is valid or not.	0: invalid 1: valid	None.	None.

MTN6725-0101

636d	ECG 1, Colour (HSV) Hue	Value	1 Byte 5.001	CW
Sets the ECG1 colour via an HSV value. A value between 0° and 360° can be transmitted. Please remember that the used data type 5.003 only allows for a resolution of about 1.4°.				
				
637	ECG 1, Colour temperature relative	Value	1 Byte 5.001	CW
Sets the ECG 1 colour temperature relatively between 0 and 100%. The value range 0 to 100% is automatically converted to the possible colour temperature range.				
637a	ECG 1, Colour (HSV) Saturation	Value	1 Byte 5.001	CW
Use this object to set the saturation. A value between 0° and 100% can be transmitted.				
638	ECG 1, Colour White	Value	1 Byte 5.001	CW
Sets the ECG1 colour. The values for white (W) are transmitted.				
639	ECG 1, Colour Control Fading	Warmer/Cooler	4 Bit 3.007	CW
The ECG1 colour can be changed using this object. Increase the angle with bit 4 set, decrease the angle with bit 4 deleted. Bit 1..3 deleted is interpreted as a stop telegram. This means that the entire circumference of the circle can be circulated and every colour can be set.				
639a	ECG 1, Colour (HSV) Fading Hue	Brighter/Darker	4 Bit 3.007	CW
Use this object to change the hue of the ECG1. Bit 4 is set to increase the angle and deleted to decrease the angle. Bit 1 to 3 deleted is interpreted as a stop telegram. As the whole colour circle is accessible, any colour can be set.				
640	ECG 1, Colour (HSV) Fading Saturation	Brighter/Darker	4 Bit 3.007	CW
See change of hue above. The value between 0 and 100% is increased incrementally.				
641	ECG 1, Colour Fading White	Brighter/Darker	4 Bit 3.007	CW
Use this object to change ECG1 colour white.				
642	ECG 1, Colour temperature	Status	2 Bytes 7.600	CRT
This object sends the set colour temperature as ECG1 status.				
642a	ECG 1, Colour RGB	Status	3 Bytes 232.600	CRT
This object sends the set RGB colour as ECG1 status.				
642b	ECG 1, Colour RGBW	Status	6 Bytes 251.600	CRT
This object sends the set RGBW colour as ECG1 status.				
642c	ECG 1, Colour XY	Status	6 Bytes 242.600	CRT
This object sends the set XY colour as ECG1 status.				

642d	ECG 1, Colour (HSV) Hue	Status	1 Byte 5.001	CRT
This object sends the set (HSV) hue colour as ECG1 status.				
643	ECG 1, Colour temperature relative	Status	1 Byte 5.001	CRT
This object sends the relative colour temperature of ECG1 as status.				
643a	ECG 1, Colour (HSV) Saturation	Status	1 Byte 5.001	CRT
This object sends the set (HSV) saturation colour as ECG1 status.				
644	ECG 1, Colour White	Status	1 Byte 5.001	CRT
This object sends the set white (W) colour as ECG1 status.				

### 19.4.3 Single ECG Emergency Setting

#### 19.4.3.1 Objects according to the new KNX standard:

Object	Object name	Function	Type	Flags
645	Converter 1, Test start	Start	1 Byte 20.611	CW
<p>Use this object to start a long duration test, function test and battery status query of the converter. The individual Bits have the following meaning:</p> <p>20.611      DPT_Converter_Test_-Control      <b>Encoding</b></p> <ul style="list-style-type: none"> <li>0 : Reserved, no effect</li> <li>1 : Start Function Test (FT) Acc. DALI Cmd. 227</li> <li>2 : Start Duration Test (DT) Acc. DALI Cmd. 228</li> <li>3 : Start Partial Duration Test (PDT) <b>not supported</b></li> <li>4 : Stop Test Acc. DALI Cmd 229</li> <li>5 to 255 : Reserved, no effect</li> </ul> <p><b>Note:</b> Concurrent tests to the same DALI converter will be supported. This DPT controls a test of a DALI converter. It allows also to stop a running test.</p> <p>Attention: The gateway does not support "Partial Duration Test" and therefore this command is not active!</p>				

646	Converter 1, Test result	Test	6 Byte 245.600	CRT
-----	--------------------------	------	-------------------	-----

This object reports the converter status according to Konnex data point type 245.600.

### 6.9 DPT\_Converter\_Test\_Result

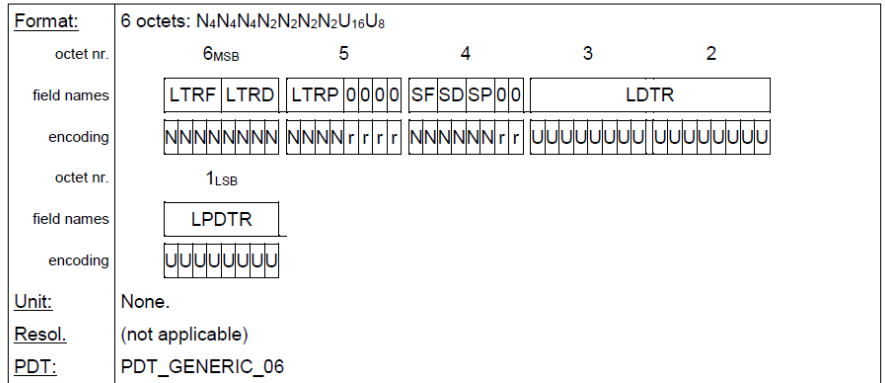

Data field	Description	Encoding	Range
LTRF	Last Test Result FT: Test result of last function test	0: Unknown 1: Passed in time 2: Passed max delay exceeded 3: Failed, test executed in time 4: Failed, max delay exceeded 5: Test manually stopped 6 to 15: Reserved, do not use	{0...15}
LTRD	Last Test Result DT: Test result of last duration test	0: Unknown 1: Passed in time 2: Passed max delay exceeded 3: Failed, test executed in time 4: Failed, max delay exceeded 5: Test manually stopped 6 to 15: Reserved, do not use	{0...15}
LTRP	Last Test Result PDT: Test result of last partial duration test	Attention: The gateway does not support "Partial Duration Test" and therefore this area is not used and stays 0!	
SF	Start Method of Last FT	0: Unknown 1: Started automatically 2: Started by Gateway 3: Reserved Updated after a test has been finished.	{0...3}
SD	Start Method of Last DT	Start Method of Last DT 0: Unknown 1: Started automatically 2: Started by Gateway 3: Reserved Updated after a test has been finished.	{0...3}
SP	Start Method of Last PDT	Attention: The gateway does not support "Partial Duration Test" and therefore this area is not used and stays 0!	
LDTR	Contains the battery discharge time as the result of the last successful duration test (DT). According DALI Cmd. 243	DPT 7.006 DPT_TimePeriodMin The max. value of 510 min shall be interpreted as 510 min or longer.	{0...510}

LPDTR	Last PDT Result Provides the remaining Battery Charge Level after the last PDT	Attention: The gateway does not support "Partial Duration Test" and therefore this area is not used and stays 0!		
647	Converter 1, Status	Status	2 Byte 244.600	CRT

This object reports the converter status according to Konnex data point type 244.600.

**6.8 DPT\_Converter\_Status**

<b>Format:</b>	2 octets: N4B4N2N2N2N2	
octet nr.	2 <sub>MSB</sub>	1 <sub>LSB</sub>
field names	CM HS	FP DP PP CF
encoding	NNNNBBBB	NNNNNNNN
<b>Unit:</b>	None.	
<b>Resol.:</b>	(not applicable)	
<b>PDT:</b>	PDT_GENERIC_02	
<b>Datapoint Types</b>		
<b>ID:</b>	<b>Name:</b>	<b>Usage:</b>
244.600	DPT_Converter_Status	FB

Data field	Description	Encoding	Range
CM	Converter Mode according to the DALI converter state machine	0: Unknown 1: Normal mode active, all OK 2: Inhibit mode active 3: Hardwired inhibit mode active 4: Rest mode active 5: Emergency mode active 6: Extended emergency mode active 7: FT in progress 8: DT in progress 9 to 15: Reserved. Shall be 0.	{0...15}
HS	Hardware Status	Bit 0: Hardwired Inhibit is active Bit 1: Hardwired switch is on Bit 2 and 3: Reserved. Shall be 0.	{0,1}
FP	Function Test Pending	0: Unknown 1: No test pending 2: Test pending 3: Reserved NOTE 26 The information about a running test is given in the Converter Mode field. NOTE 27 The status "Unknown" may for instance occur at power-up.	{0...3}

DP	Duration Test Pending	Duration Test Pending 0: Unknown 1: No test pending 2: Test pending 3: Reserved NOTE 28 The information about a running test is given in the Converter Mode field. NOTE 29 The status "Unknown" may for instance occur at power-up.	{0...3}
PP	Partial Duration Test Pending	Attention: The gateway does not support "Partial Duration Test" and therefore this area is not used and stays 0!	
CF	Converter Failure	Indicates that one or more failures were detected. Further information about the Type of failure can be found in CTR. 0: Unknown 1: No failure detected 2: Failure detected 3: Reserved	{0...3}

648	Converter 1, Battery info	Status	2 Byte 7.001	CRT
-----	---------------------------	--------	-----------------	-----

This object reports the battery status according to Konnex data point type 246.600.

### 6.10 DPT\_Battery\_Info

<u>Format:</u>	2 octets: r4B4U8	
octet nr.	2 <sub>MSB</sub>	1 <sub>LSB</sub>
field names	0000 BS	BCL
encoding	rrrrBBBB	NNNNNNNN
<u>Unit:</u>	None.	
<u>Resol.</u>	(not applicable)	
<u>PDT:</u>	PDT_GENERIC_02	
Datapoint Types		
<u>ID:</u>	<u>Name:</u>	<u>Usage:</u>
246.600	DPT_Battery_Info	FB

Field names	Description	Encoding	Range
BS	Battery Status	Bit 0: Battery Failure Acc. DALI Cmd. 252 Bit 1: Battery Duration Failure Acc. DALI Cmd. 252 Bit 2: Battery Fully Charged Bit 3 to 7: Reserved, must be 0	{0, 1}
BCL	Battery Charge Level Indicates the recent charge level	0: deep discharge point ... 254: fully charged 255: unknown or not supported According DALI Cmd. 241	{0...255}

### 19.4.3.2 Objects according to earlier versions

Object	Object name	Function	Type	Flags
--------	-------------	----------	------	-------

645	Converter 1, Test start	Start	1 Byte	CW
<p>This object is used to start a long duration test, function test and battery status query of the converter. The individual Bits have the following meaning:</p> <p>Bit 0 → Start function test          Bit 1 → Function test pending          Bit 2 → Start duration test          Bit 3 → Duration test pending          Bit 4 → Query battery status          Bit 5 → Battery status query pending          Bit 6 → Function test running          Bit 7 → Duration test running</p>				
646	Converter 1, Test result	Test	3 Byte	CRT
<p>This object is used to analyse the results of function and duration tests and the battery status. The individual bits have the following meaning:</p> <p>Bit 23..16 → If test is function or battery test: Battery status 0..100%          → If test is duration test: Test time of duration test in steps of 2 Minutes          Bit 15 → Failure during duration test          Bit 14 → Failure during function test          Bit 13 → Maximum time for duration test exceeded          Bit 12 → Maximum time for function test exceeded          Bit 11 → Emergency lamp faulty          Bit 10 → Battery faulty          Bit 9 → Battery operating hours too short          Bit 8 → Converter faulty          Bit 7 → Duration test pending          Bit 6 → Function test pending          Bit 5 → Duration test running          Bit 4 → Function test running          Bit 3 → Test failure during the last test          Bit 2 → Last test was battery query          Bit 1 → Last test was duration test          Bit 0 → Last test was function test</p>				

### 19.4.4 Single ECG objects analysis and service

635a	ECG 1, Failure Status	Status	1 Bit 1.005	CRT
Sends the failure status of lamp, ECG and converter failures.				
635b	ECG 1, Failure Status	Status	1 Byte 5.010	CRT
Sends the failure status of lamp, ECG and converter failures. Bit 0 → Lampenfehler Bit 1 → EVG Fehler Bit 2 → Konverterfehler				
649	ECG 1, Operating Hours Reset	Yes/No	1 Bit 1.015	CW
Resets the operating hours counter. <b>Note:</b> Object 579-581 is shown for the following parameter: ECG1 --> Analysis and service --> "Operation Hour Calculation" = Yes.				
650	ECG 1, Operating Hours (Seconds)	Value	4 Bytes 13.100	CRT
The operating hours of a lamp in Seconds are sent via this object. The internal counter can be set to 0 (Reset) or another value via this object. <u>Please remember:</u> The "Write" flag is switched off in the presetting.				

650a	ECG 1, Operating Hours (Hours)	Value	4 Bytes 12.102	CRT
The operating hours of a lamp in Hours are sent via this object. The internal counter can be set to 0 (Reset) or another value via this object. <b>Please remember:</b> The "Write" flag is switched off in the presetting.				
651	ECG 1, Life Time Exceeded	Yes/No	1 Bit 1.002	CRT
This object is used to send a status message when the configured life time of a lamp is exceeded.				
652	ECG 1, Active Power	Value	4 Byte 14.056	CRT
This object provides the active power of device type 51 according to DALI part 252.				
652a	ECG 1, Active Energy	Value	4 Byte 13.010	CRT
This object provides the active energy of device type 51 according to DALI part 252				

## 19.5 Motion detector /Brightness sensor objects

A set of communication objects is available for each of the up to 8 possible motion detectors. The following objects are available (example MB 1):

2165	MB1, Movement Switching	ON/Off	1 Bit 1.001	CRT
The output is switched when motion is detected.				
2165a	MB1, Movement Set Value	Value	1 Byte 5.001	CRT
A certain value can be sent when motion is detected				
2165b	MB1, Movement Set Scene	Activate	1 Byte 17.001	CRT
When motion is detected, an assigned scene is started.				
2167	MB1, Movement Off	ON/Off	1 Bit 1.001	CW
Input: The presence can be switched off directly via this object and the detector is reset.				
2168	MB1, Time without movement > Vacant	Time(s)	2 Byte 7.005	CRW
Input: Time without movement to be set using this object. <b>Attention:</b> Input values less than 10 seconds will be limited to 10 seconds. Minimal value is 10 seconds.				
2169	MB1, External Motion (Presence)	Yes/No	1 Bit 1.001	CW
Input: This object can be used to hold the "presence state" by some other external information. As long as this input is on, the motion stays on "presence mode".				
2171	MB1, Brightness	Brightness	2 Byte 9.004	CRT
Sends the value of the detected brightness as an object to the bus.				
2172	MB1, Brightness is below the Threshold	Yes/No	1 Bit 1.005	CRT

Sends an object to the bus when the value falls below the threshold.				
2173	MB1, Failure Status	Status	1 Bit 1.005	CRT
Sends the failure status as an object on the bus.				
2175a	MB1, Control Output	ON/Off	1 Bit 1.001	CRT
Output: The Value sent when Brightness is below Setpoint (Threshold)				
2175b	MB1, Control Output	Value	1 Byte 5.001	CRT
Output: The Value sent when Brightness is below Setpoint (Threshold)				
2176	MB1, Disable Automatic	ON/Off	1 Bit 1.001	CW
Input: Using this object the Light Control or Movement Detection can be activated/enabled or deactivated/disabled. By default and restart of the device the Light Control is activated.				
2177	MB1, Automatic Status	Inactive/Active	1 Bit 1.011	CRT
Output: This object indicates the Status of the Light Control.				
2178	MB1, Brightness Setpoint	Value	2 Byte 9.004	CRW
Input: The threshold Brightness Level for Brightness depending switching can be adjusted here.				

## 19.6 Generic DALI Inputs objects

A set of communication objects is available for each of the up to 8 possible generic inputs. The following objects are available (example GI 1):

2301	GI1, Temperature	Value	2 Byte 9.001	CRT
The output transmits the current temperature.				
2301a	GI1, Humidity	Value	2 Byte 9.007	CRT
The output transmits the current humidity.				
2301b	GI1, Air Quality	CO2	2 Byte 9.008	CRT
The output transmits the current CO2 Value.				
2301c	GI1, Air Quality	VOC	2 Byte 9.008	CRT
The output transmits the current VOC Value.				
2301d	GI1, Scalingc	Value	1 Byte 5.001	CRT
The output transmits the current scaling value.				
2301e	GI1, Sound [db]c	Value	1 Byte 5.010	CRT

The output transmits the current db value.				
2301f	GI1, Generic 1 Byte unsigned	Value	1 Byte 5.00x	CRT
The output transmits the current generic value.				
2301g	GI1, Generic 2 Byte float	Value	2 Byte 9.00x	CRT
The output transmits the current generic value.				
2302	GI1, xxxx is above Threshold	Yes/No	1 Bt 1.005	CRT
The output is sent in alarm status.				
2303	GI1, xxxx is below Threshold	Yes/No	1 Bt 1.005	CRT
The output is sent in alarm status.				
2302a	GI1, xxxx Alarm 1	Yes/No	1 Bt 1.005	CRT
The output is sent in alarm status.				
2302b	GI1, xxxx Alarm 2	Yes/No	1 Bt 1.005	CRT
The output is sent in alarm status.				

## 19.7 Push Button objects

A set of communication objects is available for each of the up to 8 possible push buttons. Each push button can have up to 4 button pairs. The following objects are available (example PB 1, Pair 1):

The pushbutton pair works as a connected pair

2325	PB1, Pair1, Switching	On/Off	1 Bit 1.001	CT
The output transmits the switching command.				
2326	PB1, Pair1, Dimming	Up/Down	4 Bit 3.007	CT
The output transmits the dimming command.				
2325a	PB1, Pair1, Shutter	Step	1 Bit 1.009	CT
The output transmits the step (open/close) command for slats				
2326a	PB1, Pair1, Shutter	Up/Down	1 Bit 1.008	CT
The output transmits the shutter command for moving Up/Down.				
2325b	PB1, Pair1, Value	Value	1 Byte 5.001	CWTU
The output transmits the fix value defined by parameter				
2325c	PB1, Pair1, Value	Value	1 Byte 5.001	CWTU
The output transmits the variable value defined by parameter				
2325d	PB1, Pair1, Presence	On/Off	1 Bit 1.018	CT
The output transmits the presence				

The pushbutton pair works with single buttons

2325	PB1, Pair1, Switching Left Button	Toggle On Off	1 Bit 1.001	CWTU CT
The output transmits the switching command.				
2326	PB1, Pair1, Switching Right Button	Toggle On Off	1 Bit 1.001	CWTU CT
The output transmits the switching command.				
2325a	PB1, Pair1, Switching Left Button	Value	1 Byte 5.001	CT
The output transmits the value.				
2326b	PB1, Pair1, Switching Right Button	Value	1 Byte 5.001	CT
The output transmits the value.				

2325a	PB1, Pair1, Scene Left Button	Invoke Invoke/Program	1 Byte 17.001 18.001	CT
The output transmits the scene command.				
2326b	PB1, Pair1, Scene Right Button	Invoke Invoke/Program	1 Byte 17.001 18.001	CT
The output transmits the scene command.				

## 19.8 Generic KNX Inputs objects

Communication objects are available for up to 16 generic KNX information. The following objects are available (example KNXI 1):

2389	KNXI1	Boolean .....	1 Bit 1.001	CWU
The Input is read according selected datapoint type.				
boolean	[1] 1.xxx			
scaling	[5.1] DPT_Scaling			
unsigned	[5.10] DPT_Value_1_Ucount			
unsigned	[5.4] DPT_Percent_U8			
signed	[6.10] DPT_Value_1_Count			
signed	[6.1] DPT_Percent_V8			
float	[9] 9.xxx			
float	[9.1] DPT_Value_Temp			
float	[9.6] DPT_Value_Pres			
float	[9.24] DPT_Power			
float	[9.22] DPT_PowerDensity			
float	[9.5] DPT_Value_Wsp			
float	[9.4] DPT_Value_Lux			
float	[9.7] DPT_Value_Humidity			
float	[9.10] DPT_Value_Time1			
float	[9.21] DPT_Value_Curr			
float	[9.20] DPT_Value_Volt			
float	[9.8] DPT_Value_AirQuality			
float	[9.9] DPT_Value_AirFlow			
float	[9.27] DPT_Value_Temp_F			
unsigned	[7.1] DPT_Value_2_Ucount			
unsigned	[7.13] DPT_Brightness			
signed	[8.1] DPT_Value_2_Count			
float	[14] 14.xxx			
float	[14.68] DPT_Value_Common_Temperature			
float	[14.58] DPT_Value_Pressure			
float	[14.56] DPT_Value_Power			
float	[14.31] DPT_Value_Energy			
float	[14.33] DPT_Value_Frequency			
float	[14.10] DPT_Value_Area			
unsigned	[12.1] DPT_Value_4_Ucount			
signed	[13.1] DPT_Value_4_Count			
signed	[13.10] DPT_ActiveEnergy			
signed	[13.13] DPT_ActiveEnergy_kWh			
signed	[13.2] DPT_FlowRate_m3/h			

## 20 ETS parameters

The ETS parameters of the device are distributed across different parameter pages. To simplify the overview, only the parameter pages of the device selected in the function tree are displayed.

### 20.1 General

Five parameter pages are available under the heading "General". The parameters are described below.

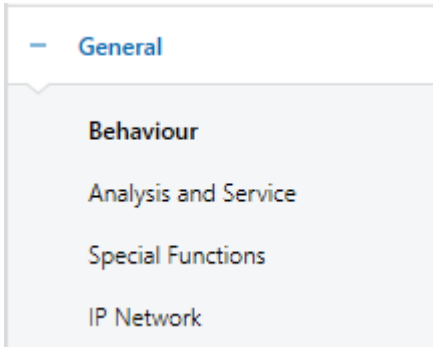

#### 20.1.1 Parameterpage: General

**General**

- Behaviour
- Analysis and Service
- Special Functions
- IP Network

**Groups**

**i** Instruction: For configuration and DALI Commissioning you need the ETS DCA App installed. Refer to Manual how to install this App.

Device Name

Additional Information (optional)

Project-ID

Building-ID

Zone-ID

Parameter	Settings						
Device Name	SpaceLogic KNX DALI Gateway Pro						
You can assign your own device name here. SpaceLogic KNX DALI Gateway Pro is preset.							
Additional information about: Project-ID, Circuit-ID, Distributionboard-ID	<table style="width: 100%; border-collapse: collapse;"> <tr> <td style="width: 30%;">Project-ID</td> <td><input style="width: 60%;" type="text"/></td> </tr> <tr> <td>Circuit-ID</td> <td><input style="width: 60%;" type="text"/></td> </tr> <tr> <td>Distributionboard-ID</td> <td><input style="width: 60%;" type="text"/></td> </tr> </table>	Project-ID	<input style="width: 60%;" type="text"/>	Circuit-ID	<input style="width: 60%;" type="text"/>	Distributionboard-ID	<input style="width: 60%;" type="text"/>
Project-ID	<input style="width: 60%;" type="text"/>						
Circuit-ID	<input style="width: 60%;" type="text"/>						
Distributionboard-ID	<input style="width: 60%;" type="text"/>						
Space for additional installation instructions (optional)							

## 20.1.2 Parameterpage: Behaviour

- General	Behaviour on KNX Failure	No Action
Behaviour	Behaviour on KNX Voltage Recovery	No Action
Analysis and Service	Senddelay for Status after KNX Recovery	10 Seconds
Special Functions	Light Status Send Condition	Send on Change
IP Network	Send Condition in Dimming Mode	inactive
+ Groups	Behaviour after Panic Mode	Switch to Last Value
+ Single ECG	Behaviour after Emergency Test	Switch to Off-Value
	General Soft Start Behaviour	Softstart 1 Second

Parameter	Settings
Behaviour on KNX Failure	<b>No Action</b> Switch to ON-Value Switch to OFF-Value Switch to Panic Value
Use this parameter to set the behaviour of the connected ECGs/lamps when a KNX failure occurs.	
Behaviour on KNX Voltage Recovery	<b>No Action</b> Switch to Last Value Switch to ON-Value Switch to OFF-Value
Use this parameter to set the behaviour of the connected ECGs/lamps on KNX voltage recovery or bus reset.	
Send delay for Status after KNX Recovery	immediately 5 Seconds <b>10 Seconds</b> 15 Seconds 20 Seconds 30 Seconds 40 Seconds 50 Seconds 60 Seconds
Sets a delay for sending status objects after KNX voltage recovery or a bus reset. In installations with more than one gateway, different settings for this parameter can prevent all devices from sending at the same time.	
Light Status Send Condition	Send on Request <b>Send on Change</b> Send on Change and after Busreset
Determines the light status send conditions (switch status and value status) of the connected ECGs and groups.	
Send Condition in Dimming Mode	If Change > 2% If Change > 5% If Change > 10% If Change > 20% <b>inactive</b>
Use this parameter to set whether and when you would like a value status to be sent via a 4 bit dimming telegram during dimming (relative dimming). If you use the setting inactive, the value is only sent after the dimming process is complete.	
Behaviour after Panic Mode	Switch to OFF-Value Switch to ON-Value <b>Switch to Last Value</b>
Use this parameter to determine which light value ECGs / lamps are to adopt after the panic mode has finished. If you use "Switch to Last Value", the value prior to the panic mode is saved and the lamp returns to this value afterwards.	

Behaviour after Emergency Test	Switch to OFF-Value Switch to ON-Value <b>Switch to Last Value</b>
Use this parameter to determine which light value ECGs / lamps are to adopt after the emergency test has finished. If you use "Switch to OFF-Value", the value prior to the emergency test is saved and the lamp returns to this value afterwards.	
General Soft Start Behaviour	No Softstart <b>Softstart 1 Second</b> Softstart 1.5 Seconds Softstart 2 Seconds
This parameter defines the general fading time if an ECG is switched on/off.	

### 20.1.3 Parameterpage: Analysis and Service

- General
- Behaviour
- Analysis and Service
- Special Functions
- IP Network
- + Groups
- + Single ECG
- + Motion/Brightness
- + Generic DALI Inputs
- + Push Buttons
- + Generic KNX Inputs

Failure Status Send Condition: Send on Change

Cycle Time for DALI Requests: 5 Seconds

---

Type of Central ECG Failure Object:  No Object  Dali Diagnose (DPT 238.600)

Failure Objects for Input Devices:  No  Yes

---

DataType to present operating hours:  Seconds (DPT 13.100)  Hours (DPT 12.102)

---

Function of Failure Object:  Total Number of Failures  Failure Rate 0..100%

Threshold for Total Failures: 1%

Threshold for Lamp Failures: 1%

Threshold for ECG Failures: 1%

Threshold for Converter Failures: 1%

---

**Energy Reporting**

**i** ECGs Device Type 51 according DALI Part 252 -Energy Reporting- provide Energy information. Required information can be read from ECG and the value is provided as KNX communication object.

Enable Energy Reporting: Active Power [W]

**i** ECGs provide delayed current consumption after changing the switching value. In addition, the value is queried cyclically every hour.

Delay time to read energy data after value change: 32 Seconds

Parameter	Settings
Failure Status Send Condition	Send on Request <b>Send on Change</b> Send on Change and after Busreset
Sets the conditions under which the failure status objects of the connected ECGs and groups are to be sent.	

Cycle Time for DALI Request	no request 0.5 Seconds 1 Second 2 Seconds 3 Seconds 4 Seconds <b>5 Seconds</b> 6 Seconds 7 Seconds 8 Seconds 9 Seconds 10 Seconds
To analyse ECG and lamp failures, a periodic request has to be sent to the ECGs via DALI telegrams. Use this parameter to set the cycles for these periodic requests.	
<b>Attention:</b> If you set "no request" ECG and lamp failures can no longer be recognised. The evaluation of emergency luminaires is no longer possible! You should therefore use this setting only during service or in special cases.	
Type of Central ECG Failure Object	<b>No Object</b> Dali Diagnose (DPT 238.600)
Use this parameter to select whether you want to use the central failure object for ECG and lamp failures (object number 28, DPT 238.600).	
Failure Objects for Input Devices	<b>No</b> Yes
The error objects can be shown via this parameter. These objects, 8 objects for motion detectors and generic inputs and 8 objects for pushbuttons are summarized at the end of the object list.	
Data Type to present operating hours	<b>Seconds (DPT 13.100)</b> Hours (DPT 12.102)
Using this parameter the operating hours can be presented as Seconds or Hours.	
Function of Failure Object	<b>Total number of Failures</b> Failure rate 0..100%
Use this parameter to select whether you want to use the failure analysis objects (objects number 16, 18, 20 and 22) to report the total amount of failures or the failure rate in %.	
Threshold for Total Failures	<b>1%</b> 2% 3% ..... 100%
Configures a threshold value for the general failure alarm object (object 16). The threshold value takes all failures (ECG, lamp and converter failures) into consideration independently of the failure type and relates them to the total number of connected ECGs and converters.	
Threshold for Lamp Failures	<b>1%</b> 2% 3% ..... 100%
Configures a threshold value for the lamp failure alarm object (object 18). The threshold value considers all lamp failures in relation to the total number of connected lamps in the DALI segment.	
Threshold for ECG Failures	<b>1%</b> 2% 3% ..... 100%
Configures a threshold value for the ECG failure alarm object (object 20). The threshold value considers all ECG failures in relation to the total number of connected ECGs in the DALI segment.	

MTN6725-0101

Threshold for Converter Failures	<b>1%</b> 2% 3% ..... 100%
Configures a threshold value for the converter failure alarm object (object 22). The threshold value considers all converter failures in relation to the total number of connected converters in the DALI segment.	
Enable Energy Reporting	<b>No</b> Active Power [W] Active Energy [Wh]
ECGs Device Type 51 according DALI Part 252 -Energy Reporting- provide Energy information. Required information can be read from ECG and the value is provided as KNX communication object. This parameter defines the type of reporting.	
Delay time to read energy data	Only cyclically every hour 4 Second .. <b>32 Seconds</b> .. 60 Seconds
The energy information will be provided by ECG within a delay. This delay depends on how the ECG is calculating the energy and therefore this value can be defined according of the ECG type. <b>Attention:</b> Due to this background, the value of the power is always calculated with a time delay In addition, the value is queried cyclically every hour. For more details refer to: <a href="#">6.1 Energy Reporting according DALI Part 252</a> <a href="#">Energy Reporting according DALI Part 252</a>	

## 20.1.4 Parameterpage: Special Functions

- General
- Behaviour
- Analysis and Service
- Special Functions
- IP Network
- Groups
- Single ECG
- Motion/Brightness
- Generic DALI Inputs
- Push Buttons
- Generic KNX Inputs

**Manual Operation on Device**

Disable Manual Operation No ▾

---

**Broadcast**

By enabling the Broadcast Function additional objects can be used to Control the DALI -System

Broadcast enabled  No  Yes

---

**Emergency**

Type of Objects for Emergency  Objects according new KNX Standard  
 Objects according legacy "old" style

---

**System Diagnostic via IP Network**

Enable System Diagnostic  No  Yes

---

**Firmware Update**

PIN Code Firmware Update 1234 ▾

**i** This PIN Code is requested during update procedure

---

**Scenes**

Dimming of Scenes enabled  No  Yes

---

**Energy Saving**

Energy Saving Objects enabled  No  Yes

Delay for Switching OFF the ECG Power 10 Seconds ▾

Delay for Switching ON the ECGs 0.2 Seconds ▾

Parameter	Settings
Enable operation on the device	<b>No</b> Yes, all settings are disabled Yes, without installation
With this parameter, manual control can be enabled directly on the device.	
Broadcast enabled	<b>Yes</b> No
This parameter can be used to enable the broadcast function in addition to group control. The activation activates a new tab "Broadcast. See chapter: <a href="#">20.2 Broadcast</a>	
<p>Broadcast enabled <span style="float: right;"><input checked="" type="radio"/> No <input type="radio"/> Yes</span></p>	
<p><b>Note:</b> When activating the broadcast function, additional objects to control the DALI system can be used and further parameters appear.</p>	

Type of Objects for Emergency	<b>Objects accirding new KNX Standard</b> Objects according legacy "old" style
<div style="border: 1px solid #ccc; padding: 10px;"> <p><b>Emergency</b></p> <p>Type of Objects for Emergency</p> <p> <input checked="" type="radio"/> Objects according new KNX Standard  <input type="radio"/> Objects according legacy "old" style                 </p> </div>	
Enable System Diagnostics	<b>No</b> Yes
<p>Allows system diagnostics over the network. Has been in the security settings → IP Network / Security Settings the option "Communication on local network, only" is selected, the possibility of external diagnostic access is disabled.</p> <div style="border: 1px solid #ccc; padding: 10px;"> <p><b>System Diagnostic via IP Network</b></p> <p>Enable System Diagnostic <input type="radio"/> No <input checked="" type="radio"/> Yes</p> <div style="border: 1px solid #add8e6; padding: 5px; margin: 5px 0;"> <p><b>i</b> Ensure that the webservice is accessible to show System Diagnostic results. Therefore, enable access in the Page "IP Settings".</p> </div> <p>System Diagnostic Multicast Address <input type="text" value="224.0.218.201"/></p> <p>Device Name <input type="text" value="DALIControl e64 Pro"/></p> <div style="border: 1px solid #add8e6; padding: 5px; margin: 5px 0;"> <p><b>i</b> Ensure that all gateways on the same system are working with the same Diagnostic Multicast Address</p> </div> </div>	
System diagnostics Multicast address	<b>224.0.2.201</b>
All gateways belonging to the system must communicate via the same multicast address.	
Device name	
The device name already defined under General Settings is displayed here. It can also be changed here. This name will be displayed later on the web page.	
Send status at least all	No <b>30 minutes</b> 60 minutes 120 minutes
A further parameter can be used to define after which time the status is to be sent if no change has occurred during this time and thus no automated event is reported.	
Delete inactive entries from the list after	6 hours 12 hours <b>1 day</b> 2 days 3 days 4 days
The inactive entries (non-active gateways) are deleted after this time.	

PIN Code Firmware Update	1234
<p><b>Firmware Update</b></p> <p>PIN Code Firmware Update <input type="text" value="1234"/></p> <p><b>i</b> This PIN Code is requested during update procedure</p> <p>This number is requested during a firmware update, see <a href="#">7.7.3 Update Firmware</a></p>	
Dimming of Scenes enabled	<b>No</b> Yes
<p><b>Scenes</b></p> <p>Dimming of Scenes enabled <input type="radio"/> No <input checked="" type="radio"/> Yes</p>	
Energy Saving Objects enable	<b>No</b> Yes
<p><b>Energy Saving</b></p> <p>Energy Saving Objects enabled <input type="radio"/> No <input checked="" type="radio"/> Yes</p> <p>When this function is activated, an energy-saving object can be selected for both groups and ECGs to switch off the power supply when the lighting is switched off.</p>	
Delay for Switching OFF the ECG Power	<b>10 Seconds</b> 30 Seconds 1 Minute 2 Minutes 5 Minutes 10 Minutes
Delay before switching off the power.	
Delay for Switching ON the ECGs	0.1 Seconds <b>0.2 Seconds</b> 0.3 Seconds ... 1 Second 2 Seconds
Delay until the ECGs are switched on. During this time the actuator controlling the power supply must have switched safely.	

## 20.1.5 Parameterpage: IP Network

- General
- Behaviour
- Analysis and Service
- Special Functions
- IP Network
- + Groups
- + Single ECG
- + Motion/Brightness
- + Generic DALI Inputs
- + Push Buttons
- + Generic KNX Inputs

Access via Web Pages enabled  No  Yes

IP Address Assignment  Fix IP-Address  DHCP

HTTPS Port

---

**Hostname Resolution (mDNS)**

**i** Due to security reason this Service shall only be used in trusted internal networks. Please, take care that router are configured to block this Service. The selected host name must be unique in the entire system.

Enable Hostname Resolution (mDNS)  No  Yes

---

**API / MQTT Functionality**

**i** By activating this interface a communication to an external Management System can be established

Enable API/MQTT  No  Yes

**x** Attention: if you going to communicate with an external partner, please set "Local Communication" in the next parameter chapter "Security Settings" to "NO"

---

**Security Settings**

Communication on local network, only  No  Yes

---

**Webpage Access**

**i** Set the Override Option only if you want to reset password to ETS Default or during the first ETS Download!

Override Username and Password with ETS Paramter  No  Yes

Listed below are the existing user names for administrator and user account

Username (Administrator)	admin
Username (User)	user

Parameter	Settings												
Access via Web Pages enabled	<b>No</b> Yes												
This can be used to deactivate the basic use of web operation for security reasons. <b>Attention:</b> An IP connection is required for the firmware update. If deactivated, no firmware update is possible!													
IP Adress Assignment	Fix IP-Adress <b>DHCP</b>												
Determines whether the device is given a fixed IP address or a dynamic IP address via DHCP. When selecting the fixed IP address, the following additional parameters are shown.													
<div style="border: 1px solid #ccc; padding: 5px;"> <table style="width: 100%; border-collapse: collapse;"> <tr> <td style="width: 30%;">IP Address Assignment</td> <td><input checked="" type="radio"/> Fix IP-Address <input type="radio"/> DHCP</td> </tr> <tr> <td>IP Address</td> <td><input type="text" value="0.0.0.0"/></td> </tr> <tr> <td>Subnet</td> <td><input type="text" value="0.0.0.0"/></td> </tr> <tr> <td>Gateway</td> <td><input type="text" value="0.0.0.0"/></td> </tr> <tr> <td>DNS Server</td> <td><input type="text" value="0.0.0.0"/></td> </tr> <tr> <td>HTTPS Port</td> <td><input type="text" value="443"/></td> </tr> </table> </div>		IP Address Assignment	<input checked="" type="radio"/> Fix IP-Address <input type="radio"/> DHCP	IP Address	<input type="text" value="0.0.0.0"/>	Subnet	<input type="text" value="0.0.0.0"/>	Gateway	<input type="text" value="0.0.0.0"/>	DNS Server	<input type="text" value="0.0.0.0"/>	HTTPS Port	<input type="text" value="443"/>
IP Address Assignment	<input checked="" type="radio"/> Fix IP-Address <input type="radio"/> DHCP												
IP Address	<input type="text" value="0.0.0.0"/>												
Subnet	<input type="text" value="0.0.0.0"/>												
Gateway	<input type="text" value="0.0.0.0"/>												
DNS Server	<input type="text" value="0.0.0.0"/>												
HTTPS Port	<input type="text" value="443"/>												

HTTP Port	443
The device has a HTTPS web server to visualize the status or to carry out commissioning. The port is set to the standard value 443.	
<b>Name resolution (mDNS)</b>	
Enable Host Name Resolution (mDNS)	Nein Ja
If enabled the device can be found by this hostname	
Host Name	
This parameter defines the Host Name.	
<div style="border: 1px solid #add8e6; padding: 5px;"> <p><b>i</b> Due to security reason this Service shall only be used in trusted internal networks. Please, take care that router are configured to block this Service. The selected host name must be unique in the entire system.</p> </div>	
<b>API / MQTT Functionality</b>	
Enable API/MQTT	No Yes
Using this parameter the API / MQTT Feature can be enabled. MQTT can be used to communicate with an external Broker to provide data to other management systems.	
<div style="border: 1px solid #add8e6; padding: 5px;"> <p><b>i</b> By activating this interface a communication to an external Management System can be established</p> </div> <p>Enable API/MQTT <input type="radio"/> No <input checked="" type="radio"/> Yes</p> <div style="border: 1px solid #f08080; padding: 5px; margin-top: 5px;"> <p><b>x</b> Attention: if you going to communicate with an external partner, please set "Local Communication" in the next parameter chapter "Security Settings" to "NO"</p> </div> <p><b>In „red“ colour you see an important hint in case you want to communicate with external partner.</b></p> <p>Settings and instructions for using MQTT are explained in chapter: <a href="#">21 API/MQTT</a>.</p>	
<b>Security settings</b>	
Communication on local network, only	No Yes
This parameter can be used to restrict the web server for operating and controlling the device via websites. By default, only requests from the local network are accepted.	
<p>Communication on local network, only <input type="radio"/> No <input checked="" type="radio"/> Yes</p> <div style="border: 1px solid #add8e6; padding: 5px; margin-top: 5px;"> <p><b>i</b> The webservice accepts request from local networks, only</p> </div>	
<b>Website access</b>	
Overwrite Username and Password with ETS Parameter.	No Yes

With this option the passwords can be reset. Refer to chapter [2 KNX Secure](#) for detailed information.

**Webpage Access**

**i** Set the Override Option only if you want to reset password to ETS Default!

Override Username and Password with ETS  No  Yes  
Paramter

**i** Password has to be changed on web page!

Account	Login Name	Password
Admin Account	admin	dali
User Account	user	user

Admin Account Entry (8 characters)

The standard operator is "admin". The default password "**dali**" must be changed on the website and has a maximum length of 8 characters. **Note:** An empty password is not allowed.

User Account Entry (8 characters)

The default operator is "**user**". The default password "**user**" must be changed on the website and has a maximum length of 8 characters. **Note:** An empty password is not allowed.

Restriction of rights for the user account	User are allowed to control lights	<input type="radio"/> No <input checked="" type="radio"/> Yes
	User are allowed to change scene configuration	<input type="radio"/> No <input checked="" type="radio"/> Yes
	User are allowed to change effect configuration	<input type="radio"/> No <input checked="" type="radio"/> Yes
	User are allowed to change schedule configuration	<input type="radio"/> No <input checked="" type="radio"/> Yes
	User are allowed to view emergency reports	<input type="radio"/> No <input checked="" type="radio"/> Yes

Here the user rights can be released or restricted.

## 20.2 Broadcast

This tab is displayed if the "Broadcast enabled" option has been activated in → [ETS parameters/General/Special Functions](#).

<ul style="list-style-type: none"> <li>General</li> <li>Behaviour</li> <li>Analysis and Service</li> <li>Special Functions</li> <li>IP Network</li> <li style="color: blue; font-weight: bold;">Broadcast</li> </ul>	<p>Objects for Broadcast Colour <span style="float: right;">RGB Colour ▾</span></p> <p>Selection of Object Type <span style="float: right;">RGB (3 Byte combined Object) ▾</span></p> <p>Status Information in the Group Object is only updated if the selected colour type is matching the group colour type.</p> <p>Object for Broadcast Colour Temperature <input type="radio"/> No <input checked="" type="radio"/> Yes</p>
--	---

<p>Objects for Broadcast Colour</p>	<p><b>No</b>                  RGB Colour                  RGBW Colour                  XY Colour</p>
<p>This defines which communication objects are to be displayed for broadcast colour control.</p> <div style="border: 1px solid #ccc; padding: 5px; margin-bottom: 10px;"> <p>none ✓</p> <p>RGB Colour</p> <p>RGBW Colour</p> <p>XY Colour</p> </div> <p>When selecting RGB / RGBW or XY colour, an additional selection window is displayed.</p> <div style="display: flex; justify-content: space-between;"> <div style="border: 1px solid #ccc; padding: 5px; width: 30%;"> <p>RGB (3 Byte combined Object) ✓</p> <p>RGB (separated objects)</p> <p>HSV (separated objects)</p> </div> <div style="width: 65%;"> <p>Selection RGB Colour</p> </div> </div> <div style="display: flex; justify-content: space-between; margin-top: 10px;"> <div style="border: 1px solid #ccc; padding: 5px; width: 30%;"> <p>RGBW (6 Byte combined object 251.600) ✓</p> <p>RGBW (separated objects)</p> <p>HSVW (separated objects)</p> </div> <div style="width: 65%;"> <p>Selection RGBW Colour</p> </div> </div> <div style="display: flex; justify-content: space-between; margin-top: 10px;"> <div style="border: 1px solid #ccc; padding: 5px; width: 30%;"> <p><input checked="" type="radio"/> XY (separated objects)</p> <p><input type="radio"/> XY (combined object 242.600)</p> </div> <div style="width: 65%;"> <p>Selection XY Colour</p> </div> </div> <p><b>Note:</b> The status information is only updated if the type of the colour control matches the type defined in the group.</p>	
<p>Object for Broadcast Colour Temperature</p>	<p>No <b>Yes</b></p>
<p>Activate object for broadcast colour temperature.</p>	

## 20.3 Groups

There are 4 parameter pages for group settings. The parameters are described below.

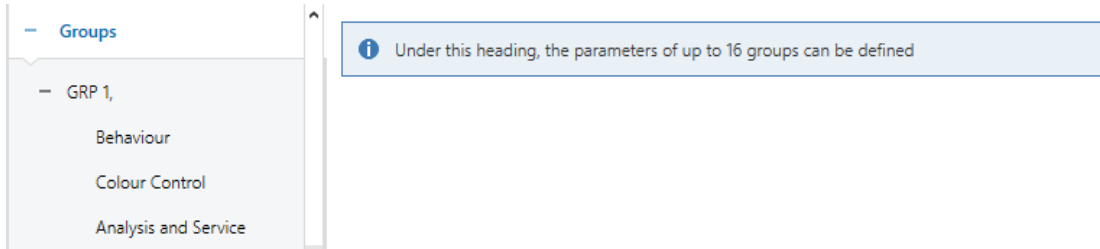

### 20.3.1 General Group1 (2.. 16)

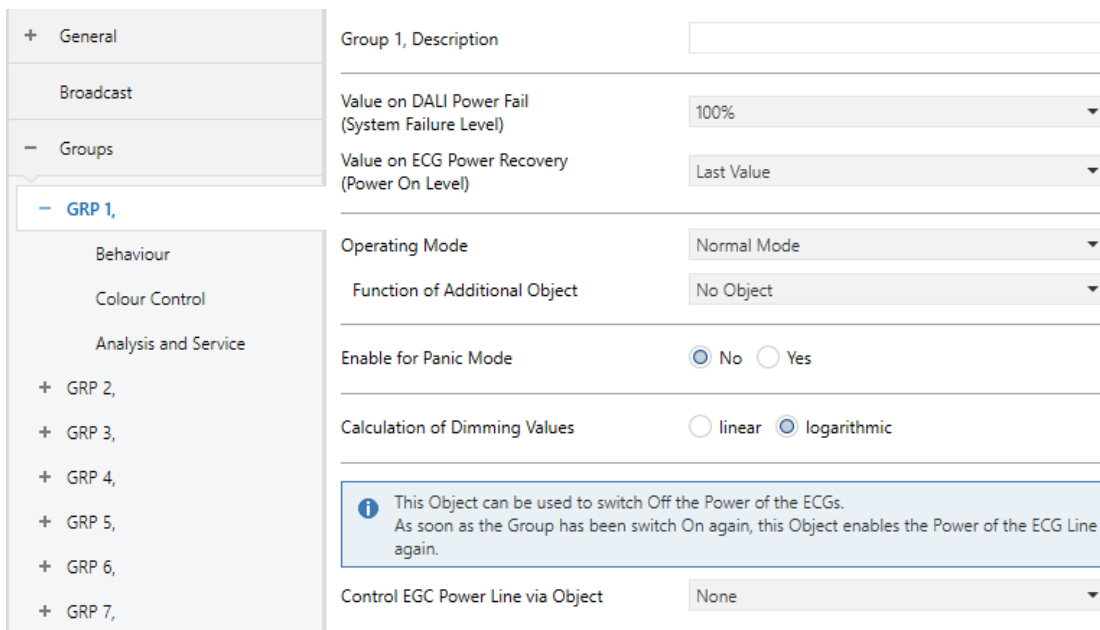

Parameter	Settings												
Group x, Description	e.g.: Room1 (window)												
<p>Use this parameter to define a group description. The description is shown for all communication objects. For example: Room1 (window).</p> <table border="1"> <tr><td>G1, Switching, Room1 (window)</td><td>On/Off</td></tr> <tr><td>G1, Dimming, Room1 (window)</td><td>Brighter/Darker</td></tr> <tr><td>G1, Set Value, Room1 (window)</td><td>Value</td></tr> <tr><td>G1, Status, Room1 (window)</td><td>On/Off</td></tr> <tr><td>G1, Status, Room1 (window)</td><td>Value</td></tr> <tr><td>G1, Failure Status, Room1 (window)</td><td>Yes/No</td></tr> </table>		G1, Switching, Room1 (window)	On/Off	G1, Dimming, Room1 (window)	Brighter/Darker	G1, Set Value, Room1 (window)	Value	G1, Status, Room1 (window)	On/Off	G1, Status, Room1 (window)	Value	G1, Failure Status, Room1 (window)	Yes/No
G1, Switching, Room1 (window)	On/Off												
G1, Dimming, Room1 (window)	Brighter/Darker												
G1, Set Value, Room1 (window)	Value												
G1, Status, Room1 (window)	On/Off												
G1, Status, Room1 (window)	Value												
G1, Failure Status, Room1 (window)	Yes/No												
Value on DALI Power Fail (System Failure Level)	0..100% [100] Last value												
<p>Use this parameter to set the value of a lamp after a loss of DALI power. The value is saved on the ECG and the device automatically changes to the value when a power loss occurs.</p>													
Value on ECG Power Recovery (Power On Level)	0..100% [100] <b>Last value</b>												
<p>Use this parameter to set the value of a lamp after a return of ECG power supply. The value is saved on the ECG and the device automatically changes to the value when power is restored.</p>													

MTN6725-0101

Operating Mode	<b>Normal Mode</b> Permanent Mode Normal/Night Mode Staircase Mode
Use this parameter to set the operating mode of a group.	
Value in permanent mode (if permanent mode is selected)	0..100% <b>[50]</b>
Use this parameter to set the value of all lamps in a group in 'permanent mode'. Lamps in this mode cannot be switched or changed. They remain at the set value.	
Behaviour in Normal / Night mode (if is selected)	<b>Delayed Switch-Off automatically</b> Delayed Switch-Off in 2 steps automatically Delayed Dimm-Off automatically Activate Permanent Mode and Ignore Telegrams
<p>This parameter can be used to set how the corresponding group behaves if night mode has been activated via the night object (No. 12). The parameter is only shown if the group is set to "Night Mode". Special settings:</p> <p><b>Delayed Switch-Off in 2 steps automatically:</b> 1 minute before the configured time the value is set to 50% of the actual value. After the configured time the switch-off value is set.</p> <p><b>Delayed Dimm-Off automatically:</b> 1 minute before the configured time, the current value is dimmed to the switch-off value.</p> <p><b>Activate Permanent Mode and Ignore Telegrams:</b></p>	
Automatic Switch OFF after	1 Minute 2 Minutes 3 Minutes 4 Minutes <b>5 Minutes</b> 10 Minutes 15 Minutes ... 90 Minutes
Use this parameter to set the time after which a group in normal/night mode automatically switches off. This parameter is only visible if you select "night mode".	
Behavior in Staircase Mode (if is selected)	<b>Delayed Switch-Off automatically</b> Delayed Switch-Off in 2 steps automatically Delayed Dimm-Off automatically
<p>This parameter can be used to set how the corresponding group behaves in staircase operation. The parameters are only shown if the group is set to "staircase function".</p> <p><b>Delayed Switch-Off in 2 steps automatically:</b> 1 minute before the configured time the value is set to 50% of the actual value. After the configured time the switch-off value is set.</p> <p><b>Delayed Dimm-Off automatically:</b> 1 minute before the configured time, the current value is dimmed to the switch-off value.</p>	
Automatic Switch OFF after	1 Minute 2 Minutes 3 Minutes 4 Minutes <b>5 Minutes</b> 10 Minutes 15 Minutes ... 90 Minutes
Use this parameter to set the time after which a group in staircase mode automatically switches off. This parameter is only visible if you select 'staircase mode'.	
Function of Additional Object	<b>No Object</b> Disable Object Release Object Staircase function Disable Object

MTN6725-0101

<p>Use this parameter to set the function of an additional object.          If you select "Disable Object", value 1 disables the operation of the group.          If you select "Release Object", value 1 enables the operation of the group.  <b>Attention:</b> The Disable function does only refer to Switch ON/OFF and SetValue via Objects</p> <p>If you select " Staircase function Disable Object", value 1 disables only the staircase function.          This can be used to temporarily disable the staircase function for example during cleaning.</p>	
Behaviour on Disable	<b>No Change</b> Switch to On-Value Switch to OFF-Value
This parameter appears when an additional object has been selected to define the behaviour when disabled.	
Behaviour on Enable	<b>No Change</b> Switch to On-Value Switch to OFF-Value Switch to state received during disable (lock)
This parameter appears when an additional object has been selected to define the behaviour when enabled.	
Enabled for Panic Mode	<b>No</b> Yes
Determines whether a group should be considered during panic mode. The panic mode is controlled via central object number 10.	
Value in Panic Mode	<b>1%</b> .. <b>50%</b> .. 100%
Use this parameter to select the value for this operating mode.	
Calculation of Dimming Values	<b>logarithmic</b> linear
Sets the dimming curve for the group.	
<div style="border: 1px solid #ccc; padding: 10px; background-color: #f0f8ff;"> <p> This Object can be used to switch Off the Power of the ECGs.          As soon as the Group has been switch On again, this Object enables the Power of the ECG Line again.</p> </div>	
Control ECG Power Line via Object	<b>None</b> Energy Saving Object 1.. 16
Here you define the object with which the power supply is to be switched off. This parameter is only visible if this function was previously set on the General → Special Functions parameter page, see <a href="#">Parameterpage: Special Functions</a>	

### 20.3.2 Behaviour

+ General	Switch-On Value	100%
Broadcast	Switch-On Behaviour	Set Value Immediately
- Groups	Switch-Off Value	0%
- GRP 1,	Switch-Off Behaviour	Set Value Immediately
Behaviour	Value-Set Behaviour	Set Value Immediately
Colour Control	Time for Dimming	10 Seconds
Analysis and Service	Max. Value for Dimming	100%
+ GRP 2,	Min. Value for Dimming	0%
+ GRP 3,	Min/Max Value is valid for	Dimming Object
+ GRP 4,	Switch-On via Dimming	Switch ON with Value Object
+ GRP 5,	ⓘ By using the 3 byte Scaling Speed the dimming time given in ETS parameter will be ignored!	
+ GRP 6,	Additional SetValue Object incl. Dimming Time	<input checked="" type="radio"/> No <input type="radio"/> Yes
+ GRP 7,		
+ GRP 8,		

Parameter	Settings
Switch-ON Value	1% 5% 10% ... 95% <b>100%</b> Last value
Use this parameter to set the switch-on value. If you select "last value", the value is set to the dimming value prior to the lamp being switched off.	
Switch-ON Behaviour	<b>Set Value Immediately</b> Dimm to Value in 3s Dimm to Value in 6s Dimm to Value in 10s Dimm to Value in 20s Dimm to Value in 30s Dimm to Value in 1 Minute Dimm to Value in 2 Minutes Dimm to Value in 5 Minutes Dimm to Value in 10 Minutes
Use this parameter to set the switch-on behaviour.	
Switch-OFF Value	<b>0%</b> 5% 10% ... 45% 50% ... 95% <b>99%</b>
Use this parameter to set the switch-off value.	

MTN6725-0101

Switch-OFF Behaviour	<b>Set Value Immediately</b> Dimm to Value in 3s Dimm to Value in 6s Dimm to Value in 10s Dimm to Value in 20s Dimm to Value in 30s Dimm to Value in 1 Minute Dimm to Value in 2 Minutes Dimm to Value in 5 Minutes Dimm to Value in 10 Minutes
Use this parameter to set the switch-off behaviour.	
Value-Set Behaviour	<b>Set Value Immediately</b> Dimm to Value in 3s Dimm to Value in 6s Dimm to Value in 10s Dimm to Value in 20s Dimm to Value in 30s Dimm to Value in 1 Minute Dimm to Value in 2 Minutes Dimm to Value in 5 Minutes Dimm to Value in 10 Minutes
Use this parameter to configure the behaviour on receipt of a new dimming value via value setting. Please remember that the dim time always refers to the full value range. Accordingly a dimming time of 30 s means a value change of 100% within 30 s. If the value within a scene is only changed by 50%, the change is performed within 15 s.	
Time for Dimming	3 Seconds 4 Seconds 5 Seconds 6 Seconds 10 Seconds 20 Seconds 30 Seconds 60 Seconds
Use this parameter to set the dim time for relative dimming in relation to a value range from 0 to 100%.	
Max. Value for Dimming	50% 55% .... 100%
Use this parameter to configure the maximum dimming value that can be set through relative dimming.	
Min. Value for Dimming	0% 0.5% 1% ... 5% .... 50%
Use this parameter to configure the minimum dim value that can be set through relative dimming.	
Min/Max Value is valid for	Dimming Object Value Object Dimming & Value Object
Use this parameter to select the object that minimum and maximum values are valid for. It is possible to set, for example, 60% via dimming and 100% via value setting.	
Switch ON via Dimming	No Switch ON with Dimming Object Switch ON with Value Object Switch ON with Dimming & Value Object

Use this parameter to select whether a switched off group should be switched on when receiving a relative 4 Bit dimming object, a value setting object or both.

Additional SetValue Object incl. Dimming Time.	No Yes
--	-----------

Determines whether the SetValue object is to be used with the combined dimming time (DPT 225.001). See object Nr. 50.

Note: If you select the 3 Byte object (combination of value and dimming time), the dimming time in the ETS is ignored.

### 20.3.3 Colour control

Parameter	Settings
Colour Control Type	<b>none</b> Colour temperature RGB colour RGBW colour XY Colour Colour temperature + RGB Colour temperature + RGBW
This parameter can be used to set which colour control should be used in this group. Please make sure that the ECGs in this group also support this type of control.	

#### 20.3.3.1 Colour Temperature

Colour Temperatur Control Type (when selecting "Colour temperature")	<div style="border: 1px solid #ccc; padding: 5px;"> <ul style="list-style-type: none"> <li style="background-color: #e0e0e0; padding: 2px;">via DT-8 (normal operation) ✓</li> <li style="padding: 2px;">via DT-6 (LED cold/warm) Master-Group</li> <li style="padding: 2px;">via DT-6 (LED cold/warm) Slave-Group</li> </ul> </div>
When "Colour Temperature" is selected, these types of control are supported.	
Via DT-8 (normal operation)	via DT-8 (normal operation) ▼
Dimming up to cold colour	<b>No</b> Yes
When this option is activated, the color temperature is changed as the light is dimmed up. The corresponding values are set in the following parameter	
Colour temperature at Value 0%	Colour Temperature at Value 0% <input type="text" value="3000"/> °K
Colour temperature at Value 100%	Colour Temperature at Value 100% <input type="text" value="6000"/> °K

Parameters for setting the colour temperature (warm) in dimmed light and (cold) in high dimmed light.	
Colour changing Fading Time via Dimming	<b>Fast (10 seconds)</b> Standard (20 seconds) Slow (40 seconds)
This parameter is used to decide how quickly the colour temperature should be changed when dimming.	
Colour changing Fading Time	<b>immediately</b> 1 second 5 seconds 10 seconds 20 seconds 30 seconds 60 seconds 90 seconds
This parameter is used to decide how quickly the colour temperature should be changed.	
Behaviour when Switching ON	<b>Keep last Object Value</b> Use ETS Parameter below
This parameter is used to decide whether the last valid colour value should always be used or basically the colour temperature that was set with the ETS. <b>Note:</b> in case of "Keep last Object Value" - <b>Attention:</b> in case of an invalid object value, the preset colour of the ETS is used.	
Colour Temperature when Switching ON	<input type="text" value="3000"/> °K
Colour temperature at power-on with the option "Use ETS Parameter below" enabled.	
Via DT-6 (LED cold/warm) Master-Group	<input type="text" value="via DT-6 (LED cold/warm) Master-Group"/>
This allows a colour temperature to be set via 2 DT-6 groups. For example, LED strips with a warm colour (3000K) are assigned to a master group and LED strips with a cold colour (6000K) to a slave group	
Colour Temperature by using 2 Groups (one for cold white, one for warm white)	
Colour Temperature for Master LED (warm)	<input type="text" value="1000"/> °K
Colour Temperature for Slave LED (cold)	<input type="text" value="6000"/> °K
Here the real values for the two LEDs are defined	
Via DT-6 (LED cold/warm) Slave-Group	<input type="text" value="via DT-6 (LED cold/warm) Slave-Group"/>
<div style="border: 1px solid #ccc; padding: 5px; background-color: #e6f2ff;">  This Group is controlled by another Master Group. Settings and Objects from the Master are valid.         </div>	
Assign according Master Group	<b>Group 1</b> Group 2 Group 3 .... Group 16
Assignment of the relevant master group.	

### 20.3.3.2 RGB



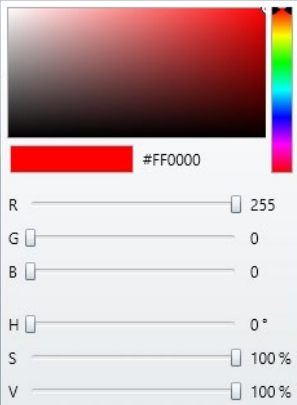

Selection of Object Type (when selecting "RGB Colour")	<input checked="" type="checkbox"/> RGB (3 Byte combined Object) ✓ <input type="checkbox"/> RGB (separated objects) <input type="checkbox"/> HSV (separated objects)
--	--

MTN6725-0101

When selecting "RGB colours", these types of control are supported.	
Time at colour change via dimming	<b>Fast (10 seconds)</b> Standard (20 seconds) Slow (40 seconds)
This parameter is used to decide how quickly the colour temperature should be changed when dimming.	
Colour changing Fading Time	<b>immediately</b> 1 second 5 seconds 10 seconds 20 seconds 30 seconds 60 seconds 90 seconds
This parameter is used to decide how quickly the colour temperature should be changed.	
Correction Value for special LED	<div style="display: flex; flex-direction: column; align-items: flex-end;"> <div style="display: flex; justify-content: space-between; width: 100%;"> <span>Intensity of Colour Red</span> <span>100</span> <span>%</span> </div> <div style="width: 100%;"><input type="range"/></div> <div style="display: flex; justify-content: space-between; width: 100%;"> <span>Intensity of Colour Green</span> <span>100</span> <span>%</span> </div> <div style="width: 100%;"><input type="range"/></div> <div style="display: flex; justify-content: space-between; width: 100%;"> <span>Intensity of Colour Blue</span> <span>100</span> <span>%</span> </div> <div style="width: 100%;"><input type="range"/></div> </div>
Under certain circumstances, the intensity of the colours red, green, blue may not be exactly matched to the illuminants and the ballast. In order to carry out a subsequent correction, the weighting of the individual colours can be changed here. An intensity of 100% means that this colour is controlled to 100%.	
Behaviour when Switching ON	<b>Keep last Object Value</b> Use ETS Parameter below
This parameter is used to decide whether the last valid colour value should always be used or basically the colour temperature that was set with the ETS.  <b>Note:</b> in case of "Keep last Object Value" - <b>Attention:</b> in case of an invalid object value, the preset colour of the ETS is used.	
Colour value at switch-on	Colour Value when Switching On <span style="background-color: red; color: white; padding: 2px;">#FF0000</span>
	This parameter defines the RGB colour when switching on. To do this, a window for colour selection is displayed via the button  in the ETS.

### 20.3.3.3 RGBW

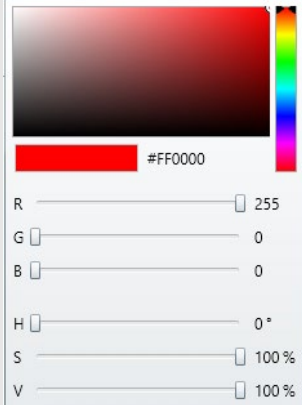
Selection of Object Type (when selecting "RGBW Colour")	<div style="border: 1px solid gray; padding: 5px;"> <div style="background-color: #e0e0e0; padding: 2px; margin-bottom: 5px;">RGBW (6 Byte combined object 251.600) <span style="float: right;">✓</span></div> <div style="padding: 2px; margin-bottom: 5px;">RGBW (separated objects)</div> <div style="padding: 2px;">HSVW (separated objects)</div> </div>
When selecting "RGBW colours", these types of control are supported. For ETS parameters see chapter: <a href="#">3 Colour control..</a>	

Behaviour when Switching ON	<b>Keep last Object Value</b> Use ETS Parameter below
<p>This parameter is used to decide whether the last valid colour value should always be used or basically the colour temperature that was set with the ETS.</p> <p><b>Note:</b> in case of "Keep last Object Value" - <b>Attention:</b> in case of an invalid object value, the preset colour of the ETS is used.</p>	
Use ETS parameters as set below	Colour Value when Switching On <span style="background-color: red; color: white; padding: 2px;">#FF0000</span>  Additional White <span style="margin-left: 150px;">255</span> 
	<p>This parameter defines the RGBW colour when switching on. To do this, a window for colour selection is displayed via the button  in the ETS.</p>

### 20.3.3.4 XY Colour



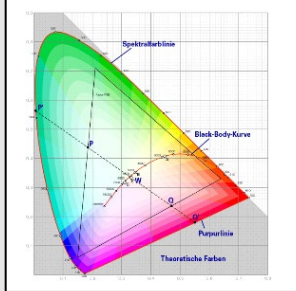

Selection of Object Type (when selecting "XY Colour")	<input checked="" type="radio"/> XY (separated objects) <input type="radio"/> XY (combined object 242.600)
<p>This parameter can be used to set which objects are to be used for control.</p>	
Colour changing Fading Time	<b>immediately</b> 1 second 5 seconds 10 seconds 20 seconds 30 seconds 60 seconds 90 seconds
<p>This parameter is used to decide how quickly the colour should be changed.</p>	
Behaviour when Switching ON	<b>Keep last Object Value</b> Use ETS Parameter below
<p>This parameter is used to decide whether the last valid colour value should always be used or basically the colour temperature that was set with the ETS.</p> <p><b>Note:</b> in case of "Keep last Object Value" - <b>Attention:</b> in case of an invalid object value, the preset colour of the ETS is used.</p>	
Use ETS Parameter below	X-Value when Switching ON (0..1) Y-Value when Switching ON (0..1)

	<p>This parameter is used to define the X colour at switching-on. The value range is between 0 and 1. X= 0.33 and Y=0.33 corresponds to the white point.</p>
---	--

### 20.3.3.5 Colour Temperature + RGB

<p>Selection of Object Type (when selecting "Colour temperature + RGB")</p>	<div style="border: 1px solid #ccc; padding: 5px;"> <p><b>RGB (3 Byte combined Object)</b> ✓</p> <p>RGB (separated objects)</p> <p>HSV (separated objects)</p> </div>
<p>When "Colour temperature + RGB" is selected, these types of control are supported.</p>	
<p>Dimming up to cold colour</p>	<p><b>No</b> Yes</p>
<p>When this option is activated, the color temperature is changed as the light is dimmed up. The corresponding values are set in the following parameter</p>	
<p>Colour temperature at Value 0% Colour temperature at Value 100%</p>	<p>Colour Temperature at Value 0% <input type="text" value="3000"/> °K Colour Temperature at Value 100% <input type="text" value="6000"/> °K</p>
<p>Parameters for setting the colour temperature (warm) in dimmed light and (cold) in high dimmed light.</p>	
<p>Time at colour change via dimming</p>	<p><b>Fast (10 seconds)</b> Standard (20 seconds) Slowly (40 seconds)</p>
<p>This parameter is used to decide how quickly the colour should be changed when dimming.</p>	
<p>Time at colour change</p>	<p><b>immediately</b> 1 second 5 seconds 10 seconds 20 seconds 30 seconds 60 seconds 90 seconds</p>
<p>This parameter is used to decide how quickly the colour should be changed.</p>	
<p>Correction value for special LED</p>	<p>Intensity of Colour Red <input type="text" value="100"/> % Intensity of Colour Green <input type="text" value="100"/> % Intensity of Colour Blue <input type="text" value="100"/> %</p>
<p>Under certain circumstances, the intensity of the colours red, green, blue may not be exactly matched to the illuminants and the ballast. In order to carry out a subsequent correction, the weighting of the individual colours can be changed here. An intensity of 100% means that this colour is controlled to 100%.</p>	
<p>Behaviour when Switching ON</p>	<div style="border: 1px solid #ccc; padding: 5px;"> <p><b>Keep last Object Value</b> ✓</p> <p>Use ETS Parameter below for Colour</p> <p>Use ETS Parameter below for Colour Temperature</p> </div>

MTN6725-0101

<p>This parameter is used to decide whether the last valid colour value should always be used or basically the colour temperature that was set with the ETS.</p> <p><b>Note:</b> in case of "Keep last Object Value" - <b>Attention:</b> in case of an invalid object value, the preset colour of the ETS is used.</p>	
Use ETS parameters as set below	Colour Value when Switching On <span style="background-color: red; color: white; padding: 2px;">#FF0000</span> 
 <p>This parameter defines the RGB colour when switching on. To do this, a window for colour selection is displayed via the button  in the ETS.</p>	
Behaviour when Switching ON	<input type="text" value="3000"/>  °K
Colour temperature on power on with the option "Use ETS parameters for colour temperature as set below" enabled.	

### 20.3.3.6 Colour Temperature + RGBW

Selection of the Object Type (when selecting "Colour Temperatur + RGBW")	<ul style="list-style-type: none"> <li style="background-color: #e0e0e0; padding: 2px;">RGBW (6 Byte combined object 251.600) </li> <li>RGBW (separated objects)</li> <li>HSVW (separated objects)</li> </ul>
When selecting "Colour Temperatur + RGBW", these types of control are supported.	
Dimming up to cold colour temperature	<b>No</b> Yes
When this option is activated, the color temperature is changed as the light is dimmed up. The corresponding values are set in the following parameter	
Colour temperature at 0%	Colour Temperature at Value 0% <input type="text" value="3000"/> °K
Colour temperature at 100%	Colour Temperature at Value 100% <input type="text" value="6000"/> °K
Parameters for setting the colour temperature (warm) in dimmed light and (cold) in high dimmed light.	
Colour changing Fading Time via Dimming	<b>Fast (10 seconds)</b> Standard (20 seconds) Slow (40 seconds)
This parameter is used to decide how quickly the colour should be changed when dimming.	
Colour changing Fading Time	<b>immediately</b> 1 second 5 seconds 10 seconds 20 seconds 30 seconds 60 seconds 90 seconds
This parameter is used to decide how quickly the colour should be changed.	

MTN6725-0101

<p>Correction Value for special LED</p>	<p>Intensity of Colour Red 100 %</p> <p>Intensity of Colour Green 100 %</p> <p>Intensity of Colour Blue 100 %</p>
<p>Under certain circumstances, the intensity of the colours red, green, blue may not be exactly matched to the illuminants and the ballast. In order to carry out a subsequent correction, the weighting of the individual colours can be changed here. An intensity of 100% means that this colour is controlled to 100%.</p>	
<p>Behaviour when Switching ON (when selecting "ETS Parameter below for Colour")</p>	<p>Keep last Object Value ✓</p> <p>Use ETS Parameter below for Colour</p> <p>Use ETS Parameter below for Colour Temperature</p>
<p>This parameter is used to decide whether the last valid colour value should always be used or basically the colour temperature that was set with the ETS.</p> <p><b>Note:</b> in case of "Keep last object value" - <b>Attention:</b> in case of an invalid object value, the preset colour of the ETS is used.</p>	
<p>Use ETS Parameter below (when selecting "ETS Parameter below for Colour Temperature")</p>	<p>Colour Value when Switching On #FF0000</p> <p>Additional White 255</p>
	<p>This parameter defines the RGB colour when switching on. To do this, a window for colour selection is displayed via the button  in the ETS.</p>
<p>Behaviour when Switching ON</p>	<p>3000 °K</p>
<p>Colour temperature on power on with the option "Use ETS parameters for colour temperature as set below" enabled.</p>	

### 20.3.4 Analyse and Service

– Groups

– GRP 1,

Behaviour

Colour Control

Analysis and Service

Additional Failure Objects  No  Yes

---

Operation Hour Calculation  No  Yes

Parameter	Settings
Additional Failure Objects	<b>No</b> Yes
Use this parameter if you want to define additional failure objects.	
Additional Failure Object for	<b>Failure threshold Exceeded</b> Failure Number/Rate
Determines whether the additional failure object should be used as a 1 Byte object for number of failures/failure rate or as a 1 Bit object for exceeding the failure threshold.	
Function of Additional Failure Object	<b>Total Number of Failures</b> Failure Rate 0..100%
Use this parameter to select either number of all failures in a group or failure rate in %. This parameter is only visible if you select "Total Number of Failures" as additional failure object.	
<div style="border: 1px solid #ccc; padding: 10px; background-color: #f9f9f9; width: fit-content; margin: 0 auto;"> <p>Additional Failure Objects <input type="radio"/> No <input checked="" type="radio"/> Yes</p> <p>Additional Failure Object for <input type="radio"/> Failure Threshold Exceeded <input checked="" type="radio"/> Failure Number/Rate</p> <p>Function of Additional Failure Object <input checked="" type="radio"/> Total Number of Failures <input type="radio"/> Failure Rate 0..100%</p> </div>	
Threshold for Total Failures	1%...100% [ <b>1%</b> ]
Use this parameter to enter the threshold in %. When the threshold is exceeded, the failure alarm object is sent. This parameter is only visible when you select "Failure Threshold Exceeded" as additional failure object.	
<div style="border: 1px solid #ccc; padding: 10px; background-color: #f9f9f9; width: fit-content; margin: 0 auto;"> <p>Additional Failure Objects <input type="radio"/> No <input checked="" type="radio"/> Yes</p> <p>Additional Failure Object for <input checked="" type="radio"/> Failure Threshold Exceeded <input type="radio"/> Failure Number/Rate</p> <p>Threshold for Total Failures <input style="width: 100px;" type="text" value="1%"/></p> </div>	
Operation Hours Calculation	Yes <b>No</b>
Use this parameter if you want to count the operating hours of a group.	
Operating Hour Limit (hours)	1 h..200.000 h [ <b>4000 h</b> ]

Sets the life span of a lamp with an individual warning being sent.

Operation Hour Calculation  No  Yes

Operating Hour Limit (hours)

## 20.4 Single ECG

The settings for the ECGs are made on two parameter pages, provided that this ECG is defined as a single ECG and has not been assigned to a group. The parameters on these pages are described below.

### 20.4.1 Single ECG General

**Single ECG**

- + ECG 1,
- + ECG 2,
- + ECG 3,

**i** In case "Dimm to cold" has been selected the Colour Temperature for 0% Value and 100% Value can be defined here.

Colour Temperature at Value 0%  \*K

Colour Temperature at Value 100%  \*K

Colour Temperature at Value 0%	Colour Temperature at Value 0% <input type="text" value="3000"/> *K
Colour Temperature at Value 100%	Colour Temperature at Value 100% <input type="text" value="6000"/> *K
Parameters for setting the colour temperature (warm) with dimmed light and (cold) with dimmed light.	
Number of ECGs to be controlled?	Number of ECGs to be controlled? <input type="text" value="2"/>
Parameter for setting the number of ECGs (0.. 64) to be installed.	

## 20.4.2 ECG 1 (2.. 64)

- Single ECG
- ECG 1,
  - Colour Control
  - Behaviour
  - Analysis and Service
- + ECG 2,
- + ECG 3,
- + ECG 4,
- + ECG 5,
- + ECG 6,
- + ECG 7,
- + ECG 8,
- + ECG 9,
- + ECG 10,
- + ECG 11,
- + ECG 12,
- + ECG 13,
- + ECG 14,
- + ECG 15,
- + ECG 16,
- + ECG 17,

ECG 1, Description

Group Assignment Single ECG

---

ECG Type ECG with Colour Control

**i** An additional tab is displayed for further color settings

---

Operating Mode Normal Mode

Function of Additional Object Release Object

Behaviour on Disable No Change

Behaviour on Enable No Change

---

ECG enabled for Panic Mode  No  Yes

---

Value on DALI Power Fail (System Failure Level) 100%

Value on ECG Power Recovery (Power On Level) Last Value

---

Calculation of Dimming Values  linear  logarithmic

---

**i** This Object can be used to switch Off the Power of the ECGs. As soon as the ECGs has been switched On again, this Object enables the Power of the ECG Line again.

---

Control EGC Power Line via Object None

Emergency Luminaire with Central Battery  No Emergency Luminaire  Central Battery Emergency Luminaire

Parameter	Settings												
ECG x, Description	e.g.: Floor, 1 level												
<p>With this parameter an ECG description can be defined. This description is displayed as an overview for all communication objects. Example for the description: Floor, 1 level.</p> <table border="1" style="width: 100%; border-collapse: collapse; margin: 5px 0;"> <tr><td>ECG 1, Switching, Floor, 1 level</td><td>On/Off</td></tr> <tr><td>ECG 1, Dimming, Floor, 1 level</td><td>Brighter/Darker</td></tr> <tr><td>ECG 1, Set Value, Floor, 1 level</td><td>Value</td></tr> <tr><td>ECG 1, Status, Floor, 1 level</td><td>On/Off</td></tr> <tr><td>ECG 1, Status, Floor, 1 level</td><td>Value</td></tr> <tr><td>ECG 1, Failure Status, Floor, 1 level</td><td>Status</td></tr> </table>		ECG 1, Switching, Floor, 1 level	On/Off	ECG 1, Dimming, Floor, 1 level	Brighter/Darker	ECG 1, Set Value, Floor, 1 level	Value	ECG 1, Status, Floor, 1 level	On/Off	ECG 1, Status, Floor, 1 level	Value	ECG 1, Failure Status, Floor, 1 level	Status
ECG 1, Switching, Floor, 1 level	On/Off												
ECG 1, Dimming, Floor, 1 level	Brighter/Darker												
ECG 1, Set Value, Floor, 1 level	Value												
ECG 1, Status, Floor, 1 level	On/Off												
ECG 1, Status, Floor, 1 level	Value												
ECG 1, Failure Status, Floor, 1 level	Status												
Group Assignment	Not assigned Group 1 ... Group 16												
The group assignment is configured via the DCA or via the website and is only displayed here.													

MTN6725-0101

ECG Type	Fluorescent Lamp Self Contained Battery Lamp (non switchable) Self Contained Battery Lamp (switchable) Self Contained Battery Lamp (switchable) + Colour Control Discharge Lamp Low Voltage Lamp Incandescent Lamp 0..10V Converter <b>LED Module</b> Relay Module ECG with Colour Control
Use this parameter to set the type of ECG used.	
ECG Type	<b>LED Module</b>
Parameters for the ECG type LED module	
Operating Mode	<b>Normal Mode</b> Permanent Mode Normal / Night Mode
This parameter allows to set the operating mode in which the ECG shall be operated. Night operation is controlled via a central object no. 12.	
Function of Additional Obejct	<b>No Obejct</b> Disable Object Release Object
This parameter can be used to define the function of an additional object. If the "Disable object" is selected, an object is displayed which blocks operation of the ECG if the value is "1". If the "Enable object" is selected, an object is displayed which enables operation of the ECG if the value is "1". <b>Note:</b> Disable function only refers to ON/OFF and value setting commands via KNX objects	
Behaviour on Disable	<b>No Change</b> Switch to On-Value Switch to OFF-Value
This parameter appears when an additional object has been selected to define the behaviour when disabled.	
Behaviour on Enable	<b>No Chance</b> Switch to ON-Value Switch to OFF-Value Switch to state received during disable (lock)
This parameter is displayed when an additional object is selected. The behaviour during activation can be defined here..	
Value in Permanent Mode	1..100% <b>[50%]</b>
This parameter allows you to set the value to which the corresponding lamp is permanently set in "Permanent" Mode. In the operating mode 'continuous operation' the lamp cannot be switched or changed, but always lights up in the set value. The parameter is only displayed if the ECG is set to 'continuous operation'.	
Behaviour in Normal / Night Mode (if is selected)	<b>Delayed Switch-Off automatically</b> Delayed Switch-Off in 2 steps automatically Delayed Dimm-Off automatically Activate Permanent Mode and Ignore Telegrams
This parameter can be used to set how the corresponding group behaves if night mode has been activated via the night object. The parameter is only shown if the group is set to "Normal Night Mode". Special settings:	
<ul style="list-style-type: none"> <li>• <b>Delayed Switch-Off in 2 steps automatically:</b> <ul style="list-style-type: none"> <li>- After the set time is set to 50% of the previous value.</li> <li>- After a further minute, the switch-off value is set.</li> </ul> </li> <li>• <b>Delayed Dimm-Off automatically:</b> <ul style="list-style-type: none"> <li>- After the set time, the switch-off value is dimmed within one minute.</li> </ul> </li> <li>• <b>Activate Permanent Mode and Ignore Telegrams:</b></li> </ul>	

MTN6725-0101

Automatic Switch-Off after (minutes)	1 minute 2 minutes 3 minutes 4 minutes <b>5 minutes</b> 10 minutes 15 minutes ... 90 minutes
This parameter is used to decide after how many minutes the ECG shall be switched off.	
Function of Additional Object	<b>No Object</b> Disable Object Release Object Staircase function Disable Object
Use this parameter to set the function of an additional object. If you select "Disable Object", value 1 disables the operation of the group. If you select "Release Object", value 1 enables the operation of the group. If you select " Staircase function Disable Object", value 1 disables only the staircase function. This can be used to temporarily disable the staircase function for example during cleaning.	
Behaviour on Enable	<b>No Change</b> Switch to On-Value Switch to OFF-Value
This parameter appears when an additional object has been selected to define the behaviour when enabled.	
Enabled for Panic Mode	<b>No</b> Yes
Determines whether a group should be considered during panic mode. The panic mode is controlled via central object number 10.	
Value in Panic Mode	1..100% [ <b>50</b> ]
Use this parameter to select the value for this operating mode.	
Value on DALI Power Fail (System Failure Level)	0..100% [ <b>100</b> ] Last value
Use this parameter to set the value of a lamp after a loss of DALI power. The value is saved on the ECG and the device automatically changes to the value when a power loss occurs.	
Value on ECG Power Recovery (Power On Level)	0..100% [ <b>100</b> ] <b>Last value</b>
Use this parameter to set the value of a lamp after a return of ECG power supply. The value is saved on the ECG and the device automatically changes to the value when power is restored.	
Calculation of Dimming Values	<b>logarithmic</b> linear
Sets the dimming curve for the group.	
<div style="border: 1px solid #add8e6; padding: 10px; background-color: #e6f2ff;"> <p> This Object can be used to switch Off the Power of the ECGs. As soon as the Group has been switch On again, this Object enables the Power of the ECG Line again.</p> </div>	
Control ECG Power Line via Object	<b>None</b> Energy Saving Object 1.. 16
Here you define the object with which the power supply is to be switched off. This parameter is only visible if this function was previously set on the General → Special Functions parameter page, see <a href="#">Parameterpage: Special Functions</a>	
Emergency Lights with Central Battery	<b>No Emergency Lighting</b> Central Battery Emergency Lighting
Use this parameter if you want the ECG to control an emergency light with central battery. Devices defined as emergency lights are specifically marked during status notifications and a special test mode can be activated via an object. This parameter is not visible if "self contained emergency light" has been selected.	

MTN6725-0101

Value in Test Mode	0..100% [50]
This parameter can be used to set the value to which the corresponding lamp is permanently set in "Test mode". In the operating mode "test mode" the lamp cannot be switched or changed, but always lights up in the set value. This parameter is only visible if "Emergency lighting with central battery" has been selected. Test mode is started with object 11.	
Duration of Test Mode (minutes)	5 Minutes .... <b>1 Hour</b> .... 4 Hours
Use this parameter to configure for how long the lamp will be on after starting the test mode. A lamp in this mode cannot be switched or changed. It remains at the set value. This parameter is only visible if you select "emergency lights with central battery".	
ECG Type	Fluorocent Lamp
Parameters for the ECG type "Fluorocent Lamp". See parameter settings for <a href="#">LED modules</a> .	
ECG Type	Self Contained Battery Lamp (non switchable)
Parameters for the ECG type "Self Contained Battery Lamp (non switchable)"	
Converter controls -	ECG 1... 64 <b>Not assigned</b>
Type of Failure Object	<b>1 bit</b> 1 byte
Here you can define whether the error is to be reported in the form of a bit (Alarm DPT 1.005) or via a byte object with the information about lamp or ballast errors, see chapter: <a href="#">19.4 Single ECG</a> objects.	
ECG Type	Self Contained Battery Lamp (switchable)
Parameters for the ECG type "Self Contained Battery Lamp (switchable)". See parameter settings for <a href="#">LED modules</a> . The parameter setting "emergency lighting with central battery" is not available for this ECG type.	
ECG Type	Self Contained Battery Lamp (switchable) + Colour Control
Parameters for the ECG type "Self Contained Battery Lamp (switchable) + Colour Control". See parameter settings for <a href="#">LED modules</a> . The parameter setting "emergency lighting with central battery" is not available for this ECG type.	
ECG Type	Discharge Lamp
Parameters for the ECG type "Discharge Lamp". → See parameter settings for <a href="#">LED modules</a> .	
ECG Type	Low Voltage Halogen Lamp
Parameters for the ECG type "Low Voltage Halogen Lamp". → See parameter settings for <a href="#">LED modules</a> .	
ECG Type	Incandescent Lamps
Parameters for the ECG type "Incandescent Lamps". See parameter settings for <a href="#">LED modules</a> .	
ECG Type	0..10V Converter
Parameters for the ECG type "0..10V Converter". → See parameter settings for <a href="#">LED modules</a> .	
ECG Type	Relais Module
Parameters for the ECG type "Relais Module". See parameter settings for <a href="#">LED modules</a> .	

ECG Type	ECG with Colour Control
Parameters for the ECG type "ECG with Colour Control". See parameter settings for <a href="#">LED modules</a> .	

### 20.4.2.1 Emergency Settings

This parameter page is only shown if "Broadcast enabled" (see chapter: [20.1.4 Parameterpage: Special Functions](#)) and the ECG type "Self Contained Battery Lamp" is selected.

- Single ECG	Value in Emergency Mode	50%
- ECG 1,	Delay on Mains Recovery	No Delay
Emergency Setting	Interval of Long Duration Test	52 Weeks
Analysis and Service	Interval of Functional Test	2 Days
+ ECG 2,	Test Execution Timeout (Days)	7

Parameter	Settings
Value in Emergency Mode	1..100% <b>[50]</b>
Sets the light value of a self-contained battery emergency light in case of a power failure or during a long duration test.	
Delay on Main Recovery	<b>No delay</b> 30 seconds 1 minute 2 minutes 3 minutes 4 minutes 5 minutes 10 minutes 10 minutes 15 minutes 20 minutes
Sets the delay until a self-contained battery lamp changes back into normal mode after power has been restored.	
Interval of Long Duration Test	No automatic test 1 week 2 week .... <b>52 weeks</b>
Use this parameter to set the intervals at which the converter is to perform automatic long duration tests.	
Interval of Functional Test	No automatic test 1 day <b>2 days</b> .... 28 days
Use this parameter to set the intervals at which the converter is to perform automatic functional tests.	
Test Execution Timeout (Days)	0..255 <b>[7]</b>
If a function or long duration test cannot be started immediately, (for example because the battery is not fully charged), the converter tries to execute the test later. Use this parameter to configure how long to attempt another test start and when to send an failure notification that the time has been exceeded. If the setting is 0, timeout will occur after 15 minutes.	

### 20.4.2.2 Behaviour

- Single ECG	Switch-On Value	100%
- ECG 1,	Switch-On Behaviour	Set Value Immediately
Behaviour	Switch-Off Value	0%
Analysis and Service	Switch-Off Behaviour	Set Value Immediately
+ ECG 2,	Value-Set Behaviour	Set Value Immediately
+ ECG 3,	Time for Dimming	10 Seconds
+ ECG 4,	Max. Value for Dimming	100%
+ ECG 5,	Min. Value for Dimming	0%
+ ECG 6,	Min/Max Value is valid for	Dimming Object
+ ECG 7,	Switch-On via Dimming	Switch ON with Value Object
+ ECG 8,		

Parameter	Settings
Switch-ON Value	1.. 100% [100] Last value
Use this parameter to set the switch-on value. If you select "Last value", the value is set to the dimming value prior to the lamp being switched off.	
Switch-ON Behaviour	<b>Set Value Immediately</b> Dimm to Value in 3s Dimm to Value in 6s Dimm to Value in 10s Dimm to Value in 20s Dimm to Value in 30s Dimm to Value in 1 Minute Dimm to Value in 2 Minutes Dimm to Value in 5 Minutes Dimm to Value in 10 Minutes
Use this parameter to set the switch-on behaviour.	
Switch-OFF Value	<b>0%</b> 5% 10% ... 45% 50% ... 95% <b>99%</b>
Use this parameter to set the switch-off value.	
Switch-OFF Behaviour	<b>Set Value Immediately</b> Dimm to Value in 3s Dimm to Value in 6s Dimm to Value in 10s Dimm to Value in 20s Dimm to Value in 30s Dimm to Value in 1 Minute Dimm to Value in 2 Minutes Dimm to Value in 5 Minutes Dimm to Value in 10 Minutes
Use this parameter to set the switch-off behaviour.	

MTN6725-0101

Value-Set Behaviour	<b>Set Value Immediately</b> Dimm to Value in 3s Dimm to Value in 6s Dimm to Value in 10s Dimm to Value in 20s Dimm to Value in 30s Dimm to Value in 1 Minute Dimm to Value in 2 Minutes Dimm to Value in 5 Minutes Dimm to Value in 10 Minutes
Use this parameter to configure the behaviour on receipt of a new dimming value via value setting. Please remember that the dim time always refers to the full value range. Accordingly a dimming time of 30 s means a value change of 100% within 30 s. If the value within a scene is only changed by 50%, the change is performed within 15 s.	
Time for Dimming	3 Seconds 4 Seconds 5 Seconds 6 Seconds <b>10 Seconds</b> 20 Seconds 30 Seconds 60 Seconds
Use this parameter to set the dim time for relative dimming in relation to a value range from 0 to 100%.	
Max. Value for Dimming	50% 55% .... <b>100%</b>
Use this parameter to configure the maximum dimming value that can be set through relative dimming.	
Min. Value for Dimming	<b>0%</b> 0.5% 1% ... 5% .... 50%
Use this parameter to configure the minimum dim value that can be set through relative dimming.	
Min/Max Value is valid for	<b>Dimming Object</b> Value Object Dimming & Value Object
Use this parameter to select the object that minimum and maximum values are valid for. It is possible to set, for example, 60% via dimming and 100% via value setting.	
Switch ON via Dimming	No Switch ON with Dimming Object <b>Switch ON with Value Object</b> Switch ON with Dimming & Value Object
Use this parameter to select whether a switched off group should be switched on when receiving a relative 4 Bit dimming object, a value setting object or both.	
Cyclic request of status	<b>No</b> Yes
Use this parameter to read the status of special ballast cyclically. <b>Attention:</b> In the special case that DALI luminaires are switched manually independently of the gateway, the status can be queried cyclically. The cycle time is set in the "Generell -> Analysis and Service" tab.	

### 20.4.2.3 Colour Control

This parameter page is only displayed if the ECG type is "Single battery emergency light (switchable) + colour control" or "ECG with colour control".

The screenshot shows the configuration page for 'Colour Control' under 'Single ECG' > 'ECG 1'. A blue information box at the top states: 'The Colour Control Type is important to set the Scene, Effect or TimeControl events'. The configuration options are:



- Colour Control Type:** Colour Temperature
- Behaviour when Switching On:**  Keep last Object Value,  Use ETS Parameter below
- Dimming up to cold colour:**  No,  Yes
- Colour changing Fading Time:** immediately
- Colour changing Fading Time via Dimming:** fast (10 Seconds)

#### 20.4.2.3.1 Colour Temperature

Parameter	Settings
Colour Control Type  <b>Note:</b> The colour control type is important to set the Scenes, Effects or TimeControl events.	none Colour Temperature ✓ RGB Colour RGBW Colour XY Colour HSV Colour HSVW Colour
This parameter can be used to set which colour control is to be used for the ECG. The default value is set to "Colour temperature".	
Colour Temperatur when Switching On	3000 °K
The set colour temperature when switched on in Kelvin.	
Dimming up to cold colour	No Yes
<b>i</b> General parameter for colour Temperature at 0% and at 100% are taken into account, see ECG>General	
See chapter: <a href="#">20.4.1 Single Single ECG</a> General.	
Behavior when Switching ON	<input checked="" type="radio"/> Keep last Object Value <input type="radio"/> Use ETS Parameter below
This parameter is used to decide whether the last valid colour value should always be used or the parameters set below should be used.  <b>Note:</b> with "Keep last object value" – <b>Attention:</b> with an invalid object value, the preset colour of the ETS is used.	

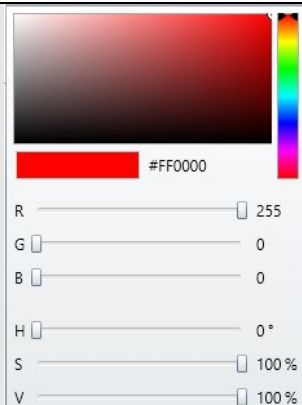

Colour changing Fading Time	<div style="border: 1px solid gray; padding: 5px;"> <p>immediately <span style="float: right;">✓</span></p> <p>1 Second</p> <p>5 Seconds</p> <p>10 Seconds</p> <p>20 Seconds</p> <p>30 Seconds</p> <p>60 Seconds</p> <p>90 Seconds</p> </div>
The set time for the colour change between immediate and 90 seconds.	
Colour changing Fading Time via Dimming	<div style="border: 1px solid gray; padding: 5px;"> <p>fast (10 Seconds) <span style="float: right;">✓</span></p> <p>standard (20 Seconds)</p> <p>slow (40 Seconds)</p> </div>
The time for the colour change when dimming is set here.	

### 20.4.2.3.2 RGB

Colour Control Type	RGB Colour
Colour control assigned to the ECG.	
Colour Value when Switching ON	#FF0000 
	<p>This parameter defines the RGB colour when switching on. To do this, a window for colour selection is displayed via the button  in the ETS.</p>

### 20.4.2.3.3 RGBW

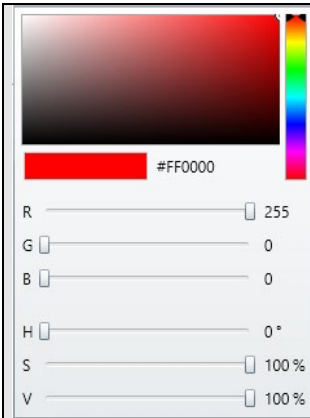
Colour Control Type	RGBW Colour
Colour control assigned to the ECG.	
Colour Value when Switching ON	#FF0000 

 <p>R <input type="text" value="255"/></p> <p>G <input type="text" value="0"/></p> <p>B <input type="text" value="0"/></p> <p>H <input type="text" value="0°"/></p> <p>S <input type="text" value="100 %"/></p> <p>V <input type="text" value="100 %"/></p>	<p>This parameter defines the RGB colour when switching on. To do this, a window for colour selection is displayed via the button  in the ETS.</p>
<p>Additional White</p>	<p>255</p> 
<p>The additional white value from 0 to 255 can be set using the slider. The increment is 1 increment. The default value is 255 (max.).</p>	

#### 20.4.2.3.4 XY Colour

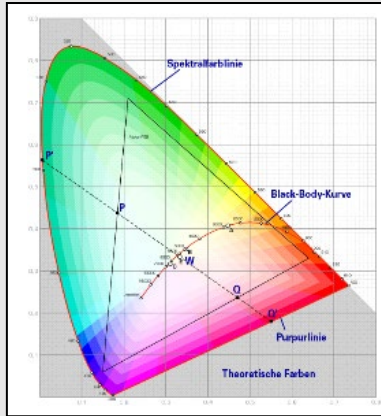
<p>Colour Control Type</p>	<p>XY Colour</p>
<p>Colour control assigned to the ECG.</p>	
<p>X-Value when Switching ON (0..1) X-Value when Switching ON (0..1)</p>	<p><input type="text" value="0.33"/> <input type="text" value="0.33"/></p>
	<p>This parameter defines the X colour when switching on. The range of values is between 0 and 1. X = 0.33 and Y = 0.33 correspond to the white point.</p>

#### 20.4.2.3.5 HSV

<p>Colour Control Type</p>	<p>HSV Colour</p>
<p>Parameters for the colour control type "HSV colour". → see parameter settings for <a href="#">RGB colour</a>.</p>	

### 20.4.2.3.6 HSVW

Colour Control Type	HSVW Colour
Parameters for the colour control type "HSV colour". → see parameter settings for <a href="#">RGBW colour</a> .	

## 20.4.2.4 Analysis and Service

- Single ECG
  - ECG 1,
    - Colour Control
    - Behaviour
    - Analysis and Service
  - + ECG 2,

Type of Failure Object  1 bit  1 byte

Operation Hour Calculation  No  Yes

**i** DiiA Specification DALI Part 252-Energy Reporting (Device Type 51)  
Set in General->Analysis and Services the requested info type.

Energy Reporting  No  Yes

Type of the failure object	1 bit 1 byte
Here you can define whether the error is to be reported in the form of a bit (Alarm DPT 1.005) or via a byte object with the information about lamp or ballast errors, see Chapter: <a href="#">19.4 Single Single ECG</a> objects . <b>Note: The 1 Byte object is a NON DPT type and will not be implemented in future versions</b>	
Operating hours Calculation	Yes <b>No</b>
This parameter can be used to set whether an individual operating hours count for the group is desired.	
Operating hours Limit value (hours) (Calculation for operating hours).	1 h..200.000 h <b>[4000 h]</b>
This parameter is used to set the lamp life at which an individual warning is sent.	
<div style="border: 1px solid #ccc; padding: 10px; width: fit-content;"> <p>Operation Hour Calculation <span style="float: right;"><input type="radio"/> No <input checked="" type="radio"/> Yes</span></p> <p>Operating Hour Limit (hours) <input style="width: 100px;" type="text" value="4000"/></p> </div>	
Energy Reporting	Yes <b>No</b>
This parameter can be used to enable the energy reporting service.	
<div style="border: 1px solid #add8e6; padding: 5px; margin: 5px 0;"> <p><b>i</b> DiiA Specification DALI Part 252-Energy Reporting (Device Type 51) Set in General-&gt;Analysis and Services the requested info type.</p> </div>	

## 20.5 Motion/Brightness Detector

### 20.5.1 Motion/Brightness General

- Motion/Brightness

- + MB1,
- + MB2,
- + MB3,

**i** The DALI Gateway supports DALI Movement Detectors with Light Level Sensing according DALI IEC 62386 Part 303/304

Parameter	Settings										
MB x, Description	<b>e.g. x, Floor 1, Building 2</b>										
<p>This parameter can be used to define a motion detector description. This description is displayed for an overview for all communication objects. Example: MB1, Floor1, Building 2.</p> <table border="1" style="width: 100%; border-collapse: collapse; margin-top: 10px;"> <tr><td>MB1, Movement Switching, Floor1, Building 2</td><td>On/Off</td></tr> <tr><td>MB1, Movement Off, Floor1, Building 2</td><td>On/Off</td></tr> <tr><td>MB1, Brightness, Floor1, Building 2</td><td>Brightness</td></tr> <tr><td>MB1, Failure Status, Floor1, Building 2</td><td>Status</td></tr> <tr><td>MB1, Brightness is below the Threshold, Floor1, Building 2</td><td>Yes/No</td></tr> </table>		MB1, Movement Switching, Floor1, Building 2	On/Off	MB1, Movement Off, Floor1, Building 2	On/Off	MB1, Brightness, Floor1, Building 2	Brightness	MB1, Failure Status, Floor1, Building 2	Status	MB1, Brightness is below the Threshold, Floor1, Building 2	Yes/No
MB1, Movement Switching, Floor1, Building 2	On/Off										
MB1, Movement Off, Floor1, Building 2	On/Off										
MB1, Brightness, Floor1, Building 2	Brightness										
MB1, Failure Status, Floor1, Building 2	Status										
MB1, Brightness is below the Threshold, Floor1, Building 2	Yes/No										
Type of Sensor	<b>Motion+Brightness</b> Motion only Brightness only										
<p>This parameter defines the support of Motion and/or Brightness.</p> <div style="border: 1px solid #add8e6; padding: 5px; margin-top: 10px; display: inline-block;"> <p><b>i</b> Motion and Brightness Settings are available on a new parameter page.</p> </div>											
Type of Light Control	<b>none</b> Light Control via Threshold										
<p>If a Light Control is required a new Parameterpage will be displayed.</p>											

### 20.5.2 Motion

Parameter	Settings
Number of Instances	<b>1 .... 7</b>
<p>A well known use case is the master/slave concept in a long corridor. In such a situation more than one movement detector have to be installed and they should work together to light the corridor. In order to support more than one instance the according ETS parameter has to be set.</p>	
<b>DALI Configuration</b>	

Time without movement > Vacant (Off-Delay)	<div style="border: 1px solid gray; padding: 5px;"> <p>none</p> <p>1 Minute</p> <p>2 Minutes</p> <p>3 Minutes</p> <p>4 Minutes</p> <p style="background-color: #e0e0e0;">5 Minutes ✓</p> <p>7 Minutes</p> <p>10 Minutes</p> <p>15 Minutes</p> <p>20 Minutes</p> <p>25 Minutes</p> <p>30 Minutes</p> <p>35 Minutes</p> <p>40 Minutes</p> </div>
After this time, the presence is deactivated, i.e. if no movement is detected in this preset time, it can be assumed that no person is within the range of the motion detector. IEC62386-303 (Hold Timer)	
Time without movement via Object (Off-Delay)	<b>Parameter</b> Parameter + Set by Object
This parameter defines if the off delay, mentioned above, can be adjusted by a communication object.	
Off-Delay after Startup	<b>Use ETS Parameter</b> Keep last Object Value
This parameter is visible, if an external object for the Off-Delay has been used. In this case, the startup behaviour can be defined by this parameter.	
Object Type for Output	<b>Switch Object</b> Set Value Object Scene Object
Selection of the object type which is sent to the bus.	
Value in Presence State	<b>0 to 100%</b>
Value to be called in Presence State.	
Value in Vacant State	<b>0 to 100%</b>
Value to be called in Vacant State.	
Scene in Presence State	<b>Scene 1 to 64</b>
Scene to be called in Presence State.	
Scene in Vacant State	<b>Szene 1 bis 64</b>
Scene to be called in Vacant State.	
Cyclic Sending	<div style="border: 1px solid gray; padding: 5px;"> <p>only on movement detection ✓</p> <p>2 Seconds</p> <p>5 Seconds</p> <p>10 Seconds</p> <p>20 Seconds</p> <p>30 Seconds</p> <p>1 Minute</p> <p>2 Minutes</p> <p>3 Minutes</p> <p>4 Minutes</p> </div>
Selection of behaviour in cycle sending mode.	

MTN6725-0101

Usage of Disable Object	<b>No</b> Disable with Value 0 Disable with Value 1
Here you define how the disable object is to be used.	
Behaviour on Disable	<b>Deactivate detection</b> Deactivate and turn OFF immediately Deactivate and turn ON immediately
Using this parameter the Behaviour in case of switching to "disable mode" can be defined. By returning back to normal mode, the detection is activated again.	
Activate Automatic Fallback to Normal Mode	<b>No</b> Yes
It is also offered the possibility switching back to normal mode (enable detection) automatically. In this case the next parameter defined the time.	
Fallback Time to Normal Mode after	1 Minute... <b>10 Minutes</b> ....4 Hours
Here the fallback time to normal mode is defined.	
Activate External Trigger (Master/Slave) via Object	<b>No</b> Yes
If this parameter is set to "Yes", an additional object is displayed and a "1" telegram is equivalent to "Motion detected".	

### 20.5.3 Brightness

Parameter	Settings
Number of Instances	<b>1</b> .... 7
A well known use case is calculating the brightness depending of more than one brightness sensor as an average value. This parameter here defines the number of instances which should taken into account for the final brightness value.	
<b>DALI Configuration</b>	
Deadtime between Brightness Events	<div style="border: 1px solid #ccc; padding: 5px;"> <ul style="list-style-type: none"> <li>none</li> <li>1 Second</li> <li style="background-color: #e0e0e0;">2 Seconds <span style="float: right;">✓</span></li> <li>3 Seconds</li> <li>4 Seconds</li> <li>5 Seconds</li> <li>6 Seconds</li> <li>8 Seconds</li> <li>10 Seconds</li> </ul> </div>
Specification of a fixed period of time after which the current brightness value is sent.	
Hysteresis in %	<input style="width: 100%;" type="text" value="10"/> %
Value of the hysteresis in % [0 .. 25]. The standard value is set to 10%.	
Send Value by change of	<input style="width: 100%;" type="text" value="10"/> lux
Send value by changing in % [1 .. 250]. The standard value is set to 10%.	

Cyclical sending	<ul style="list-style-type: none"> <li>No</li> <li>2 Seconds</li> <li>5 Seconds</li> <li>10 Seconds</li> <li>20 Seconds</li> <li>30 Seconds</li> <li>1 Minute</li> <li>2 Minutes</li> <li>3 Minutes</li> <li>4 Minutes</li> </ul>
Specification of a fixed period of time after which the current brightness value is sent.	
<b>Brightness Correction</b>	
Brightness Correction Value	0
Increase / decrease of the measured brightness (Lux) by the set value. [-500 .. +500]. The default is 0 (no correction).	
Room Reflexion	0% .. 200%
An additional reflection factor can be defined here. The default is 100% (no correction).	
<b>Threshold alarm</b>	
Threshold alarm activated at	500 lux
Setting the brightness threshold above which the limit alarm is activated.	
Hysteresis for Threshold Alarm	20 lux
Value of the switch-on delay (hysteresis) in% [1 .. 250]. The standard value is set to 20%.	
Behavior when Value < Threshold	Send OFF when Value < Threshold <b>Send ON when Value &lt; Threshold</b>
Selection of the send behavior when the limit is exceeded.	

## 20.5.4 Light Control

Parameter	Settings
Setpoint Brightness	500 lux
Entry of the brightness setpoint value of the switch-on threshold. The value can be between 0 - 2000 lux. Default setting is 500 lux.	
Setpoint Brightness Hysteresis	10 lux <b>20 lux</b> .. 100 lux
Hysteresis of the brightness setpoint value.	
Setpoint Value based on	<b>Parameter</b> Parameter + Set by Object
If this parameter is set to "Parameter + Set by Object", an additional object will be displayed in order to adjust the level (threshold).	
Setpoint Start Behaviour	<b>Use ETS Parameter</b> Keep last Object Value

MTN6725-0101

This parameter is visible, if an external object for the Brightness Level has been used. In this case, the startup behaviour can be defined by this parameter.									
Switch Off Behaviour	<b>No presence is detected</b> No presence is detected or brightness is sufficient								
In case the light is On because the brightness is below the setpoint (threshold) there are 2 options to switch off the light again. Option 1: The light is switched off only if no presence is detected anymore. Option 2: The light is switched off if the brightness is above setpoint again independently of the presence detection.									
Delay time for correct calculation	5 <b>.6.</b> 15 Seconds								
In case of Option 2 the additional artificial light has to be taken into account to allow a correct switch off behaviour. Therefore, a delay time is necessary.									
<div style="border: 1px solid #ccc; padding: 5px; background-color: #e6f2ff;"> <p><b>i</b> Delay time to calculate the artificial light component for the regulation. The brightness sensor should have detected the added light after this time.</p> </div>									
Light groups to be controlled	<b>Main Group</b> Main Group + 1 Sub Group Main Group + 2 Sub Groups								
The light control can directly work with internal DALI groups instead of using KNX objects. By default it is possible to control one main group. In case there is a large room there are further options to control up to 2 sub groups in addition.									
<p><b>Attention:</b> If using internal groups the group configuration itself has higher priority. Example: If the Light Control is working with Group 1 and Group 1 is set to disable mode or panic mode, the Light Control Module is not working, because the setting of the group itself has higher priority.</p>									
Main Group controls internal Group	<b>Not assigned</b> Group 1 .. Group 16								
Here the group number to be controlled can be defined.									
In case more than one group shall be controlled there are new parameter visible to define the relationship between the groups:									
<div style="border: 1px solid #ccc; padding: 5px; background-color: #e6f2ff;"> <p><b>i</b> A weighting can be specified for the control of the subgroups. A value of 100% means that the value of the main group is transferred 1:1 to the subgroups.</p> </div> <table style="width: 100%; border-collapse: collapse;"> <tr> <td style="width: 60%;">Factor for Sub-Group 1</td> <td style="width: 40%;">120%</td> </tr> <tr> <td>Sub-Group 1 controls internal</td> <td>Not Assigned</td> </tr> <tr> <td>Factor for Sub-Group 2</td> <td>80%</td> </tr> <tr> <td>Sub-Group 2 controls</td> <td>Not Assigned</td> </tr> </table>		Factor for Sub-Group 1	120%	Sub-Group 1 controls internal	Not Assigned	Factor for Sub-Group 2	80%	Sub-Group 2 controls	Not Assigned
Factor for Sub-Group 1	120%								
Sub-Group 1 controls internal	Not Assigned								
Factor for Sub-Group 2	80%								
Sub-Group 2 controls	Not Assigned								
Factor for Sub-Group x	<b>120%</b> 50% .. 200%								
Here you can define the weighting of the sub-group measured against the main group.									
Sub-Group x controls internal	<b>Not assigned</b> Group 1 .. Group 16								
Here the group number to be controlled can be defined.									
Object Type for output	<b>Switch Object</b> Set Value Object								

MTN6725-0101

<p>The type of object to be activated in case the brightness is below setpoint (threshold) can be defined as a 1 bit or 1 byte (value) object.          If brightness is below the switch object is ON, the value of the 1 byte value object can be defined with next parameter.</p> <p>The behaviour and the condition to switch off again can be defined with another parameter described above, refer to <a href="#">Fehler! Verweisquelle konnte nicht gefunden werden.</a></p>	
Output Value	<b>100%</b> 0% .. 100%
The 1 byte value to be sent if brightness is below setpoint (threshold)	
Cyclical sending	<ul style="list-style-type: none"> <li>No</li> <li>2 Seconds</li> <li>5 Seconds</li> <li>10 Seconds</li> <li>20 Seconds</li> <li>30 Seconds</li> <li>1 Minute</li> <li>2 Minutes</li> <li>3 Minutes</li> <li>4 Minutes</li> </ul>
Specification of a fixed period of time after which the current output value is sent.	
A manual override of the groups involved deactivates the light control	<b>Yes</b> No
When overwriting the groups belonging to the control via object values, scenes or effects, the control can be deactivated, refer to: <a href="#">5 Light Control Module</a>	
Usage of Disable Automatic Object	Disable with Value 0 <b>Disable with Value 1</b>
Here you define how the disable object is to be used.	
Behaviour on Disable Automatic Mode	<b>Keep last value</b> Turn OFF immediately Turn ON immediately
Using this parameter the Behaviour in case of switching to "disable mode (inactive)" by the object "Disable Automatic" can be defined.	
Activate Fallback to Automatic Mode	<b>No</b> Yes
It is also offered the possibility switching back to automatic mode (enable detection) automatically. In this case the next parameter defined the time.	
Fallback Time to Automatic Mode after	1 Minute... <b>10 Minutes</b> .....4 Hours
Here the fallback time to automatic mode is defined.	

## 20.6 Generic DALI Inputs

More and more manufacturer of DALI-2 Movement Detectors also provide different kinds of measurement:

- Brightness
- Temperature
- Humidity
- AIR quality
- .....

This information can also be assigned to ETS communication objects. The following parameter describe the conversion factor and the setting of required threshold alarm:

Description	<input type="text"/>
Type of Input Signal	Temperature
<b>KNX Configuration</b>	
Polling Rate	1 Minute
<div style="border: 1px solid #ccc; padding: 2px; background-color: #e6f2ff;">             ⓘ The Value can be converted into proper format by <math>f(x) = a*x + b</math>.         </div>	
Multiplicative Factor a	10 x 0.1
Additive Factor b	0 x 0.1
Value sending condition	Send on Request
<b>Threshold Alarm</b>	
Activate Threshold Alarms	<input type="radio"/> No <input checked="" type="radio"/> Yes
Threshold Alarm when value >	25 °C
Threshold Alarm when value <	18 °C
Hysteresis for Threshold Alarm	5 x 0.1 °K
Behaviour in Alarm Status	<input checked="" type="radio"/> Send ON when Value < Threshold <input type="radio"/> Send OFF when Value < Threshold

Parameter	Settings
Description	
Use this parameter to define a description.	
Type of Input Signal	<b>Temperature</b> Humidity CO2 VOC Scaling [%] Sound [db] Generic 1 Byte unsigned Generic 2 Byte float
According this definition the correct data type of communication object is selected.	

MTN6725-0101

Polling Rate on DALI	<ul style="list-style-type: none"> <li>1 Minute</li> <li>not used</li> <li>10 Seconds</li> <li>20 Seconds</li> <li>30 Seconds</li> <li>40 Seconds</li> <li>50 Seconds</li> <li>1 Minute</li> <li>2 Minutes</li> <li>3 Minutes</li> <li>4 Minutes</li> <li>5 Minutes</li> </ul>
<p>Generic Inputs of DALI Input Device are being polled. Often there is no DALI Standard for such inputs. In order to reduce DALI traffic the poll rate should be defined as small as possible. Sample: for temperature signal a poll rate &gt; 1 Minute is sufficient.</p>	
<p> The Value can be converted into proper format by <math>f(x) = a*x + b</math>.</p>	
Multiplicative Factor a	<b>10</b> x0.1 Range -128 .. +128
<p>Due to the situation that there is no standard it might be necessary that the value received from the DALI input device has to be converted. The conversion can be done via <math>f(x) = ax + b</math> A value a=10 is converted into 1. A value a=100 is converted into 10.</p>	
Additive Factor b	<b>0</b> x0.1 Range -128 .. +128
<p>According to the description mentioned above. A value b=0 is converted into 0. A value b=100 is converted into 10.</p>	
Value sending condition	<b>Send on Request</b> Send on Change Send on Change and after Busreset
<p>Use this parameter to define the conditions of sending the Value.</p>	
Send Value by change of	<b>5</b> x0.1 Range 0 .. 255
<p>This parameter specifies at which change the value is sent on the KNX. Sending event if the value has been changed by 0.5 results in the parameter „5“.</p>	
Activate Threshold Alarms	<b>No</b> Yes
<p>By setting this parameter to „Yes“ an additional threshold alarm is activated. <b>Attention:</b> The type of alarming is different according to the type of input signal.</p>	
Threshold Alarm when value >	25
Threshold Alarm when value <	18

Type: Temperature and Humidity

In this type of input signal a value range is defined for status „good“ and outside this range the status „alarm“

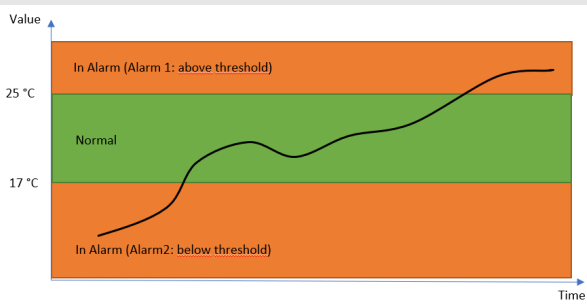

Threshold Alarm when value >  
 Threshold Alarm when value >

800  
 1200

Type: CO2 and VOC

In this type of input signal two threshold limits can be defined in order to allow a pre-alarm.



Hysteresis for Threshold Alarm

**0.5 °C**  
 2% or  
 16 ppm

According to the input signal the requested hysteresis can be defined.











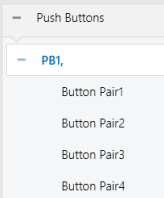

Behaviour in Alarm Status

**Send ON when Value in Alarm**  
 Send OFF when Value in Alarm

This parameter defines the value send in alarm or normal status.

## 20.7 Push Buttons

The DALI Gateway supports DALI Push Button according DALI IEC 62386 Part 301/332. Up to 8 push button with up to 8 buttons each can be configured.

Parameter	Settings															
Description																
Use this parameter to define a description.																
Number of Buttons	2-fold 4-fold 6-fold <b>8-fold</b>															
<p>This parameter defines the number of buttons. Only a number of pairs is supported. According to this parameter additional tabs are being displayed:</p> 																
Number of Instances	<b>1 Instance</b> 2 Instances 3 Instances 4 Instances															
<p>A push button can be supplied by up to 4 instances. The normal use case is the 1:1 assignment with 1 instance. But in special use cases it makes sense to allow more than 1 instance. Sample use case: A room with 2 door entrances: On each door there is one push button, but the functionality should be the same for both push buttons. In the ETS we define "ONE" push button, but we link 2 different instances of 2 different real push buttons to the ETS element in the DCA. Internally, the parameterised function is executed when either the one or the other real button is pressed.</p> <p>DCA View:</p> <p>PB01 (Room with 2 entrance)</p> <table border="1"> <thead> <tr> <th>Type</th> <th>Flag</th> <th>Description</th> </tr> </thead> <tbody> <tr> <td></td> <td>-</td> <td>PB01 (Room with 2 entrance)</td> </tr> <tr> <td></td> <td>-</td> <td>PB01 (Room with 2 entrance)</td> </tr> <tr> <td></td> <td>-</td> <td>PB01 (Room with 2 entrance)</td> </tr> <tr> <td></td> <td>-</td> <td>PB01 (Room with 2 entrance)</td> </tr> </tbody> </table>		Type	Flag	Description		-	PB01 (Room with 2 entrance)		-	PB01 (Room with 2 entrance)		-	PB01 (Room with 2 entrance)		-	PB01 (Room with 2 entrance)
Type	Flag	Description														
	-	PB01 (Room with 2 entrance)														
	-	PB01 (Room with 2 entrance)														
	-	PB01 (Room with 2 entrance)														
	-	PB01 (Room with 2 entrance)														

## 20.7.1 Push Buttons Pair

Pair1, Description

Function of 1. pair

Direction of buttons  
 Left: Off/Down, Right: On/Up  
 Left: On/Up, Right: Off/Down

Function of Internal Usage

Parameter	Settings
Description	
Use this parameter to define a description.	
Function of pair	<ul style="list-style-type: none"> <li>No function</li> <li>Switch On/Off</li> <li>Switching / Dimming with stop telegramm</li> <li>Shutter</li> <li>Set value fix</li> <li>Set value in steps</li> <li>Presence</li> <li>Single Buttons</li> </ul>
Here the general function of the push button can be selected. A special mode is the selection "single button". In this case the button pair is splitted into single button with single functionality.	
Feedback available	<b>No</b> Yes
According IEC 61386-332 Feedback elements of push-buttons are being supported. If there is a DALI input device with LED feedback available, the next parameter defines the type of control.	
Feedback LED Left	<b>Always OFF</b> Always ON Status Status invers
This parameter defines the type of control.	
Feedback LED Right	<b>Always OFF</b> Always ON Status Status inverse
This parameter defines the type of control.	
Direction of buttons	<b>Left: Off/Down, Right: On/Up</b> Left: On/Up, Right: Off/Down
This parameter defines the direction and usage of the button pair.	
Function of Internal Usage	<b>No function</b> Set Group Set ECG
The function of the push button can also be directly used to interact with internal DALI Groups or ECGs. The advantage is that no group address has to be used and so an easy and quick configuration can be done. This possibility is available for: <ul style="list-style-type: none"> <li>• Switch On/Off</li> <li>• Switching / Dimming</li> <li>• Set value fix</li> <li>• Set value in steps</li> </ul>	
Group Number to be set	<b>1 ..16</b>

If internal usage is required here the Group number can be defined to be set by the button.	
ECG Number to be set	1 ..64
If internal usage is required here the ECG number can be defined to be set by the button.	
<b>Function: Set Value fix</b>	
Value left button	0% .. 100%
Value to be sent by pressing left button	
Value right button	0% .. 100%
Value to be sent by pressing right button	
<b>Function: Set Value in steps</b>	
Value Step size	2% <b>5%</b> 10% 20% 33% 50%
Value increased or decreased by given value and to be sent	

## 20.7.2 Push Buttons Single Button

Each button can be used as a single button left and right. In this description, only one single button is described.

Pair1, Description

Function of 1. pair

---

Single Button 1 (Left Button)

Function of Single Button No. 1

**i** Function can be directly assigned to GROUP or ECG without linking via KNX group addresses

Function of Internal Usage

---

Single Button 2 (Right Button)

Function of Single Button No. 2

**i** Function can be directly assigned to GROUP or ECG without linking via KNX group addresses

Function of Internal Usage

Parameter	Settings
-----------	----------

MTN6725-0101

Function of Single Button No.1	<ul style="list-style-type: none"> <li>On</li> <li>Off</li> <li><b>Toggle</b></li> <li>Set value</li> <li>Toggle value</li> <li>Scene invoke</li> <li>Scene invoke/programm</li> <li>Effect start/stop (intern only)</li> </ul>
The available functions to be used in single button mode are listed here.	
<b>Function: Switch On/Off/Toggle</b>	
Function of Internal Usage	<b>No function</b> Set Group Set ECG
The function of the push button can also be directly used to interact with internal DALI Groups or ECGs. The advantage is that no group address has to be used and so an easy and quick configuration can be done.	
Group Number to be set ECG Number to be set	<b>1 .. 16</b> <b>1 .. 64</b>
If internal usage is required here the Group or ECG number can be defined to be set by the button.	
<b>Function: Set Value, Toggle Value</b>	
Value 1 Value 2 (only in function „toggle value“)	<b>0% .. 100% (in steps of 5%)</b> <b>0% .. 100% (in steps of 5%)</b>
By pressing the button this value will be sent.	
Function of Internal Usage	<b>No function</b> Set Group Set ECG
The function of the push button can also be directly used to interact with internal DALI Groups or ECGs. The advantage is that no group address has to be used and so an easy and quick configuration can be done.	
Group Number to be set ECG Number to be set	<b>1 .. 16</b> <b>1 .. 64</b>
If internal usage is required here the Group or ECG number can be defined to be set by the button.	
<b>Function: Switch On/Off/Toggle,Set Value, Toggle Value</b>	
Feedback available	<b>No</b> Yes
According IEC 61386-332 Feedback elements of push-buttons are being supported. If there is a DALI input device with LED feedback available, the next parameter defines the type of control.	
Feedback LED Left or LED Right	<b>Always OFF</b> Always ON Status Status inverse
This parameter defines the type of control.	
<b>Function: Scene invoke, Scene invoke/program</b>	
KNX Scene Number to be set	<b>1 .. 64</b>
This parameter defines the KNX Scene number to be sent via communication object.	
Function of Internal Usage	<b>No function</b> Scene

The function of the push button can also be directly used to interact with internal DALI Scenes.  
The advantage is that no group address has to be used and so an easy and quick configuration can be done.

Internal Scene Number to be set	<b>1 .. 16</b>
---------------------------------	----------------

This parameter defines the internal DALI Scene number to be set.

**Function: Effect start/stop (intern only)**

Function of Internal Usage	<b>No function</b> Effect start Effect stop
----------------------------	---

The function of the push button can also be directly used to interact with internal DALI Scenes.  
The advantage is that no group address has to be used and so an easy and quick configuration can be done.

Internal Effect Number to be set	<b>1 .. 16</b>
----------------------------------	----------------

This parameter defines the internal Effect number to be started or stopped.

## 20.8 Generic KNX Inputs

In this section up to 16 KNX Inputs can be defined with the purpose to transmit information from the KNX system to MQTT.

Parameter	Settings
Description	
Use this parameter to define a description.	
Data Type	<ul style="list-style-type: none"> <li>2 Byte float</li> <li>1 bit</li> <li>1 Byte (0..100%)</li> <li>1 Byte unsigned</li> <li>1 Byte signed</li> <li>2 Byte unsigned</li> <li>2 Byte signed</li> <li>2 Byte float</li> <li>4 Byte unsigned</li> <li>4 Byte signed</li> <li>4 Byte float</li> <li>no object</li> </ul>
The data Type defines the general type of value to be transmitted	
Unit Type	<ul style="list-style-type: none"> <li>°C (DPT9.001)</li> <li>No unit (Float value)</li> <li>°C (DPT9.001)</li> <li>Pa (DPT9.006)</li> <li>kW (DPT9.024)</li> <li>W/m2 (DPT9.022)</li> <li>m/s (DPT9.005)</li> <li>lux (DPT9.004)</li> <li>% Humidity (DPT9.007)</li> <li>s (DPT9.010)</li> <li>mA (DPT9.021)</li> <li>mV (DPT9.020)</li> <li>ppm (DPT9.008)</li> <li>air flow (m3/h - DPT9.009)</li> <li>°F (DPT9.027)</li> </ul>
Depending on the data type different units are offered and the according DPT for the communication object is selected	

---

## 21 API/MQTT

### 21.1 General

There is an increasing demand for IoT functionality in order to alert or notify users anywhere over the internet.

The communication protocol selected is MQTT ([Message Queuing Telemetry Transport \(MQTT\) protocol](#)). It is a light weight protocol, which has a very low footprint to send and receive data.

So, it uses very less amount of data to send and receive information. Therefore, MQTT is one of the best to open KNX data to the IoT world.

### 21.2 MQTT Basics

#### 21.2.1 MQTT Client

The Dali Gateway works as a MQTT client.

“A Client always establishes the Network Connection to the Server.

It can

- “Publish” Application Messages that other Clients might be interested in.
- “Subscribe” to request Application Messages that it is interested in receiving.
- “Unsubscribe” to remove a request for Application Messages.
- “Disconnect” from the Server.

Refer to: <http://docs.oasis-open.org/mqtt/mqtt/v3.1.1/os/mqtt-v3.1.1-os.html>

#### 21.2.2 MQTT Broker

Each MQTT Client has to connect to a so-called Broker. The broker is at the heart of any publish/subscribe protocol. Depending on the implementation, a broker can handle up to millions of concurrently connected MQTT clients.

Therefore, **it is important that the broker is highly scalable. The part of MQTT Broker is not described in this document.**

#### 21.2.3 MQTT Security

The MQTT specification does not define anything else on top of TCP, however the transport layer security (TLS) is recommended to be used.

### 21.3 MQTT Communication

The MQTT connection is always between one client and the broker. Clients never connect to each other directly. Once the connection is established, the broker keeps it open until the client sends a disconnect command or the connection breaks.

Due to this method, there is no problem at all for clients that are located behind a NAT (Router). No additional management of Router NAT tables and port forwarding is necessary anymore.

#### 21.3.1 Client-Id

The client identifier (Client-Id) **identifies each MQTT client** that connects to an MQTT broker. The broker uses the Client-Id to identify the client and the current state of the client. Therefore, this Id should be unique per client and broker.

Client-ID should be unique for all Dali Gateways and in the broker management.

The Client-ID, by default, contains the key word “dali” in conjunction with the unique serial number.

The client-ID can be changed by user via Web Frontend. The maximum number of character is 23.

### 21.3.2 Topics

In MQTT, the word topic refers to a char string that the broker uses to filter messages for each connected client. The topic consists of one or more topic levels. Each topic level is separated by a forward slash (topic level separator).

This results in various method to identify an information.

The topic structure can be defined on the root level to a certain DALI gateway or can be defined in an abstract way to make the structure independent of any Dali gateway hardware.

In current implementation the predefined topic structure contains the client-id as a fix assignment to the Dali Gateway.

### 21.3.3 Topic Structure and payload

The main topic up to the gateway can contain several location attributes, like:  
[PROJECTID/][BUILDINGID/][ZONEID/]client-Id

The client-ID identifies the current DALI Gateway.

The location part [PROJECTID/][BUILDINGID/][ZONEID/] can be defined by ETS configuration.

Each part can have a charcter length of 20 char.

## 21.4 MQTT Configuration page

Provided, that in ETS API/MQTT has been enabled, the configuration can be defined in Adminstartor tab of the Website.

#### API / MQTT Functionality

 By activating this interface a communication to an external Management System can be established

Enable API/MQTT  No  Yes

 Attention: if you going to communicate with an external partner, please set "Local Communication" in the next parameter chapter "Security Settings" to "NO"

#### Security Settings

Communication on local network, only  No  Yes

The configuration distinguish between:

- Connection
- Subscription
- Publication

[Apply](#)

ConnectionSubscriptionPublication

Auth

Connection status ●

TLS

### 21.4.1 Connection

The following entries have to be filled:

MQTT Server Adress:

Client ID: predefined with "dali" + serial number"

MQTT Server Port: predefined with "8883"

TLS: predefined "YES"

Keep Alive (s): predefined with "60"

Communication Timeout (ms): predefined with "1000"

Auth: authorisation defined by MQTT Server (Broker)

### 21.4.2 Subscription

Subscription can be used to allow commands from external sources.

The predefined prefix is "cmd/", but could be changed on this page.

### 21.4.3 Publication

Right now 5 different information are provided:

- Groups
- Ecgs
- Emergency Lights
- Sensors
- KNX datapoints

The tag name for this part of topic can be changed on this page.

## 21.5 Publication and Payload

### 21.5.1 Root Level ([location]/client-id)

On this root level the gateway provides three properties:

- status (always retained)
- info (always retained)
- statistics (always retained)
- config (always retained)

#### 21.5.1.1 Sub-Topic status

The Sub-Topic status indicates the online/offline status. The offline status is propagated by the Last Will command.

This information is published as “retained”

### 21.5.1.2 Sub-Topic info

Device specific information are provided. This information is published as “retained”

### 21.5.1.3 Sub-Topic statistics

Here the general statistics are being prenesetted:

Number of Lamps  
Number of ECGs  
Number of Converter  
Number of Lamp Failure  
Number of ECG Failure  
Number of Converter Failure  
Failure Rate Lamps  
Failure Rate ECG  
Failure Rate Converter  
Failure Rate Gateway  
General Failure Mode

```
{  
  "CntLamps": 7,  
  "CntEcgs": 6,  
  "CntConverter": 1,  
  "LampFailures": 0,  
  "EcgFailures": 0,  
  "ConverterFailures": 0,  
  "LampFailRate": 0,  
  "EcgFailRate": 0,  
  "ConverterFailRate": 0,  
  "TotalFailRate": 0,  
  "FailMode": 0  
}
```

The general “FailMode” defines the status in a bitset, according:

Bit 0 Lamp Failure  
Bit 1 ECG Failure  
Bit 2 Converter Failure  
Bit 3 Not Used  
Bit 4 KNX Failure  
Bit 5 DALI Failure

### 21.5.1.4 Sub-Topic config

The information of the static configuration is divided into group and ecg parts.

#### 21.5.1.4.1 Sub-Topic config/groups

```
[  
  {  
    "Number": 1,  
    "Name": "Group 1",  
    "ColorType": 0,  
    "CntEcgs": 1,  
    "CntConverter": 0  
  },  
  ..  
]
```

Up to 16 group information are stored in this topic.

Each group contains information about the Description, the Colour Type defined in ETS, the number of ECGs and the number of assigned converter.

Definition of Colour Type:

- 0: no Colour
- 4: ColorTemp
- 5: xy Colour
- 6: RGBW
- 7: RGB
- 8: HSV
- 9: HSVW
- 10: CT+RGBW;
- 11: CT+RGB
- 12: CT+HSV
- 13: CT+HSVW
- 14: CT Master
- 15: CT Slave

#### 21.5.1.4.2 Sub-Topic config/ecgs

```
[  
  {  
    "Number": 1,  
    "ShortAddress": 6,  
    "LongAddress": 3430086,  
    "GroupNumber": 3,  
    "Name": "ECG No. 1",  
    "DeviceType": 6,  
    "ColorType": 0  
  },  
  ..  
]
```

Up to 64 ECG information are stored in this topic.

Each ECG part contains the number, the short and long address, the group number in case it is assigned to a group, the name, device type and the colour type.

In Case of Single ECG usage, not assigned to any group, the group number is set to 0.

Definition of Colour Type:

- 0: no Colour
- 4: ColorTemp
- 5: xy Colour
- 6: RGBW
- 7: RGB
- 8: HSV
- 9: HSVW

### 21.5.1.5 Sub-Topic energy

```
{  
  "Value": 0,  
  "Unit": "Wh"  
}
```

### 21.5.1.6 Sub-Topic power

```
{  
  "Value": 0,  
  "Unit": "W"  
}
```

## 21.5.2 Group Level ([location]/client-id/group/index)

By default the Group Level topic is called "group".

However, it can be modified on web MQTT configuration page. The maximul length is 15 char.

Administrator

Connection Subscription Publication Apply

Publish Groups				
dali00ef26a0006f/	<input type="text" value="group"/>	QoS	<input type="text" value="0"/>	Retain <input type="checkbox"/>
Publish Emergency Lights				
Publish Sensors				

### 21.5.2.1 Sub-Topic status

Each group index indicates the value and current mode in json format:

```
{  
  "Mode": 0,  
  "Value": "0%"  
}
```

Mode is defined according:

Bit 0	1 Byte	Permanent Mode
Bit 1	1 Byte	Panikbetrieb
Bit 2	1 Byte	Emergency Test Mode
Bit 3	1 Byte	Group Disable
Bit 4	1 Byte	PowerSwitchOff
Bit 5	1 Byte	AutoSwitchOff
Bit 6	1 Byte	Staircase Disable Mode
Bit 7	1 Byte	Lifetime Exceeded

### 21.5.2.2 Sub-Topic colour

```
"Colour": {  
  "tc": 1345,  
  "rgbw": {  
    "r": 255,  
    "g": 255,  
    "b": 128,  
    "w": 0  
  }  
}
```

<tc> ::= "tc": <Colour-Temperatur>  
<rgb> ::= "rgb": { "r": <0-255>, "g": <0-255>, "b": <0-255> }  
<rgbw> ::= "rgbw": { "r": <0-255>, "g": <0-255>, "b": <0-255>, "w": <0-255> }  
<hsv> ::= "hsv": { "h": <0..255>, "s": <0-100>, "v": <0-100> }  
<hsvw> ::= "hsvw": { "h": <0..255>, "s": <0-100>, "v": <0-100>, "w": <0-255> }  
<xy> ::= "xy": { "x": <0-65535>, "y": <0-65535> }

### 21.5.2.3 Sub-Topic statistics

```
{  
  "CntLamps": 1,  
  "CntEcgs": 1,  
  "CntConverter": 0,  
  "LampFailures": 0,  
  "EcgFailures": 1,  
  "ConverterFailures": 0,  
  "FailRate": 100,  
  "OperatingHours": 0  
}
```

### 21.5.2.4 Sub-Topic energy

```
{  
  "Value": 0,  
  "Unit": "Wh"  
}
```

### 21.5.2.5 Sub-Topic power

```
{  
  "Value": 0,  
  "Unit": "W"  
}
```

### 21.5.3 Ecg Level ([location]/client-id/ecg/index)

By default the ECG Level topic is called "ecg".  
However, it can be modified on web MQTT configuration page. The maximul length is 15 char.

#### Administrator

Apply

Connection
Subscription
Publication

Publish Groups

Publish Ecgs

dali00ef26a0006f/

ecg

QoS

0 ▾

Retain

Publish Emergency Lights

#### 21.5.3.1 Sub-Topic status

Each ecg index indicates the value and current mode in json format:

```
{
  "Mode": 0,
  "Value": "0%"
}
```

Mode is defined according:

Bit 0	1 Byte	Permanent Mode
Bit 1	1 Byte	Panikbetrieb
Bit 2	1 Byte	Emergency Test Mode
Bit 3	1 Byte	not used
Bit 4	1 Byte	PowerSwitchOff
Bit 5	1 Byte	AutoSwitchOff
Bit 6	1 Byte	Staircase Disable Mode
Bit 7	1 Byte	Lifetime Exceeded

#### 21.5.3.2 Sub-Topic colour

```
{
  "tc": 1345
}
```

<tc> ::= "tc": <Colour-Temperatur>  
 <rgb> ::= "rgb": { "r": <0-255>, "g": <0-255>, "b": <0-255> }  
 <rgbw> ::= "rgbw": { "r": <0-255>, "g": <0-255>, "b": <0-255>, "w": <0-255> }  
 <hsv> ::= "hsv": { "h": <0..255>, "s": <0-100>, "v": <0-100> }  
 <hsvw> ::= "hsvw": { "h": <0..255>, "s": <0-100>, "v": <0-100>, "w": <0-255> }  
 <xy> ::= "xy": { "x": <0-65535>, "y": <0-65535> }

### 21.5.3.3 Sub-Topic alarm

Each ecg indicates the alarm status in json format:

```
{  
  "Alarm": 0  
}
```

### 21.5.3.4 Sub-Topic energy

```
{  
  "Value": 0,  
  "Unit": "Wh"  
}
```

### 21.5.3.5 Sub-Topic power

```
{  
  "Value": 0,  
  "Unit": "W"  
}
```

## 21.5.4 Sensor Level ([location]/client-id/sensor/index)

Administrator

[Apply](#)

Connection Subscription Publication

Publish Groups
Publish Ecgs
Publish Emergency Lights
Publish Sensors
Publish KNX Datapoints

### 21.5.4.1 Sub-Topic presence

Each sensor index indicates the brightness, if configured, and current Error in json format:

```
{  
  "Error": 0,  
  "Value": 1  
}
```

#### 21.5.4.2 Sub-Topic brightness

Each sensor index indicates the brightness (lux), if configured, and current Error in json format:

```
{  
  "Error": 0,  
  "Value": 228  
}
```

#### 21.5.4.3 Sub-Topic temperature

Each sensor index indicates the temperature (°C), if configured, and current Error in json format:

```
{  
  "Error": 0,  
  "Value": 20.2  
}
```

#### 21.5.4.4 Sub-Topic humidity

Each sensor index indicates the humidity (%), if configured, and current Error in json format:

```
{  
  "Error": 0,  
  "Value": 52  
}
```

#### 21.5.4.5 Sub-Topic co2

Each sensor index indicates the air quality (CO2 in ppm), if configured, and current Error in json format:

```
{  
  "Error": 0,  
  "Value": 528  
}
```

#### 21.5.4.6 Sub-Topic voc

Each sensor index indicates the air quality (VOC in ppm), if configured, and current Error in json format:

```
{  
  "Error": 0,  
  "Value": 528  
}
```

#### 21.5.4.7 Sub-Topic sound

Each sensor index indicates a sound (db) type, if configured, and current Error in json format:

```
{  
  "Error": 0,  
  "Value": 76  
}
```

#### 21.5.4.8 Sub-Topic genericUnsigned

Each sensor index indicates a generic value type, if configured, and current Error in json format:

```
{  
  "Error": 0,  
  "Value": 128  
}
```

#### 21.5.4.9 Sub-Topic genericFloat

Each sensor index indicates a generic value type, if configured, and current Error in json format:

```
{  
  "Error": 0,  
  "Status": 77.89  
}
```

### 21.5.5 KNX Datapoint Level ([location]/client-id/knx/index)

In the ETS configuration up to 16 KNX Inputs can be defined in order to publish the information via MQTT.

#### 21.5.5.1 Sub-Topic knx

```
{  
  "Value": 22,  
  "Unit": "°C"  
}
```

## 21.5.6 Emergency Level ([location]/client-id/emergency/index)

**Attention:** The index is linked to the device short address and NOT to ETS ECG Number!

Administrator

Connection Subscription **Publication** Apply

Publish Groups

Publish Emergency Lights

dali00ef26a0006f/ emergency QoS 0 Retain

Publish Sensors

### 21.5.6.1 Sub-Topic emstatus

Each self-contained emergency ECG indicates the Status in json format:

```
{  
  "ShortAdr": 6,  
  "EtsNumber": 10,  
  "State": 1,  
  "EmStatus": 8,  
  "EmMode": 130,  
  "EmFailure": 0  
}
```

ECG Short address as well as associated ETS number is part of this information block.

The "State" field indicates the State Machine according:

1<sup>st</sup> nibble (bit 0 – 3):

0: Unknown, 1: Normal Mode, 2: Inhibit Mode, 3: Fixed Inhibit Mode 4: Rest-Mode, 5: Emergency Mode, 6: Extend. Emergency Mode, 7: FT running, 8: DT running

2<sup>nd</sup> nibble (bit 4 – 7):

Bit 4	1 Bit	FT Manually Started
Bit 5	1 Bit	DT Manually Started
Bit 6	1 Bit	FT Pending
Bit 7	1 Bit	DT Pending

The "EMStatus" field indicates original result of DALI query 253.

The "EMMode" field indicates original result of DALI query 250.

The "EMFailure" field indicates original result of DALI query 252.

### 21.5.6.2 Sub-Topic emtest

Each self-contained emergency ECG indicates the Test-Report json format:

```
{  
  "ShortAdr": 6,  
  "EtsNumber": 10,  
  "TestResult": 255,  
  "TestMode": 1,  
  "TestFlags": 0,  
  "Hour": 15,  
}
```

```
"Minute": 15,  
"Second": 22,  
"Day": 9,  
"Month": 11,  
"Year": 21  
}
```

ECG Short address as well as associated ETS number is part of this information block.

TestResult indicates the result:

[0..254] for 0..100% in Function Test (value 255 means "invalid")  
[0..255] in minutes multiplied by 2 for Duration Test result

TestMode indicates the type of test:

- 1: Function Test
- 2: Duration Test
- 4: Battery Test

TestFlags:

- Bit 0: Inverter Circuit Fault
- Bit 1: Battery Duration Fault
- Bit 2: Battery Fault
- Bit 3: Lamp Fault
- Bit 4: Delay Fault

Time Stamp: Time in Date/Time when this result has been generated

## 21.6 Commands and Payload

The MQTT Interface allows to send commands to special topics.  
This option has to be "enabled" in the configuration page of the Website.  
A command is indicated with "cmd/" prefix in front of the topic.

### Administrator

Connection   Subscription   Publication

Enable Command Subscription    QoS    Allow Retained

### 21.6.1 Group Level (cmd/[location]/client-id/group/index)

#### 21.6.1.1 Sub-Topic status

Allowed payload content: on|off  
Take care using lower case

#### 21.6.1.2 Sub-Topic value

Allowed payload content: 0% .. 100% or 0 ..255

### 21.6.1.3 Sub-Topic tc

Allowed payload content: 0..10000

### 21.6.1.4 Sub-Topic colour

Allowed payload content: <colour-hex> | <colour-json>

<colour-hex>

#red,green,blue,white (coded 0..255)

<colour-json>

```
{  
  "rgb": { "r": 0..255, "g": 0..255, "b": 0..255 }  
  Or  
  "rgbw": { "r": 0..255, "g": 0..255, "b": 0..255, "w": 0..255 }  
}
```

```
{  
  "hsv": { "h": 0..360, "s": 0..100, "v": 0..100 }  
  Or  
  "hsvw": { "h": 0..360, "s": 0..100, "v": 0..100, "w": 0..255 }  
}
```

```
{  
  "xy": { "x": 0.0..1.0, "y": 0.0..1.0 }  
}
```

## 21.6.2 ECG Level (cmd/[location]/client-id/ecg/index)

### 21.6.2.1 Sub-Topic status

Allowed payload content: on|off

Take care using lower case

### 21.6.2.2 Sub-Topic value

Allowed payload content: 0% .. 100% or 0 ..255

### 21.6.2.3 Sub-Topic tc

Allowed payload content: 0..10000

### 21.6.2.4 Sub-Topic colour

Allowed payload content: <colour-hex> | <colour-json>

```
<colour-hex>  
#reg,green,blue,white (coded 0..255)
```

```
<colour-json>  
{  
  "rgb": { "r": 0..255, "g": 0..255, "b": 0..255}  
  Or  
  "rgbw": { "r": 0..255, "g": 0..255, "b": 0..255, "w": 0..255}  
}
```

```
{  
  "hsv": { "h": 0..360, "s": 0..100, "v": 0..100}  
  Or  
  "hsvw": { "h": 0..360, "s": 0..100, "v": 0..100, "w": 0..255}  
}
```

```
{  
  "xy": { "x": 0.0..1.0, "y": 0.0..1.0 }  
}
```

---

## 22 FAQ

### 22.1 Web Access

The IP address is called up in the browser, but the message "This page is not available" is displayed.

- a.) The web page access must be activated in the ETS.
- b.) The IP address must be entered in the form "https://<ip>".

### 22.2 Security

Despite an imported root certificate no "secure" closed lock is displayed.

Probably the IP address was changed and no new certificate was created. Please create a new device certificate as administrator.

Despite a regeneration of an outdated device certificate, no "secure" closed lock is displayed.

Probably, the Dali Gateway Pro does not have KNX Date/time information so it cannot provide the needed updated date information for the certificate to become valid.

After several failed logins, the device cannot be logged in and is no longer accessible.

After 3 failed login attempts, the connection to this IP address is blocked for one minute for security reasons.

The IP address of the DALI GW is correctly configured, but the device cannot be reached via a router or over the internet.

In the default setting, access is only allowed in local networks. This setting must be changed in the ETS.

The password has been forgotten.

An ETS download with the corresponding settings must be carried out. Afterwards the user is asked to enter a new and secure password

What is meant by network segmentation?

The following is a schematic example of network segmentation with the use of Virtual Local Area Networks (VLAN).

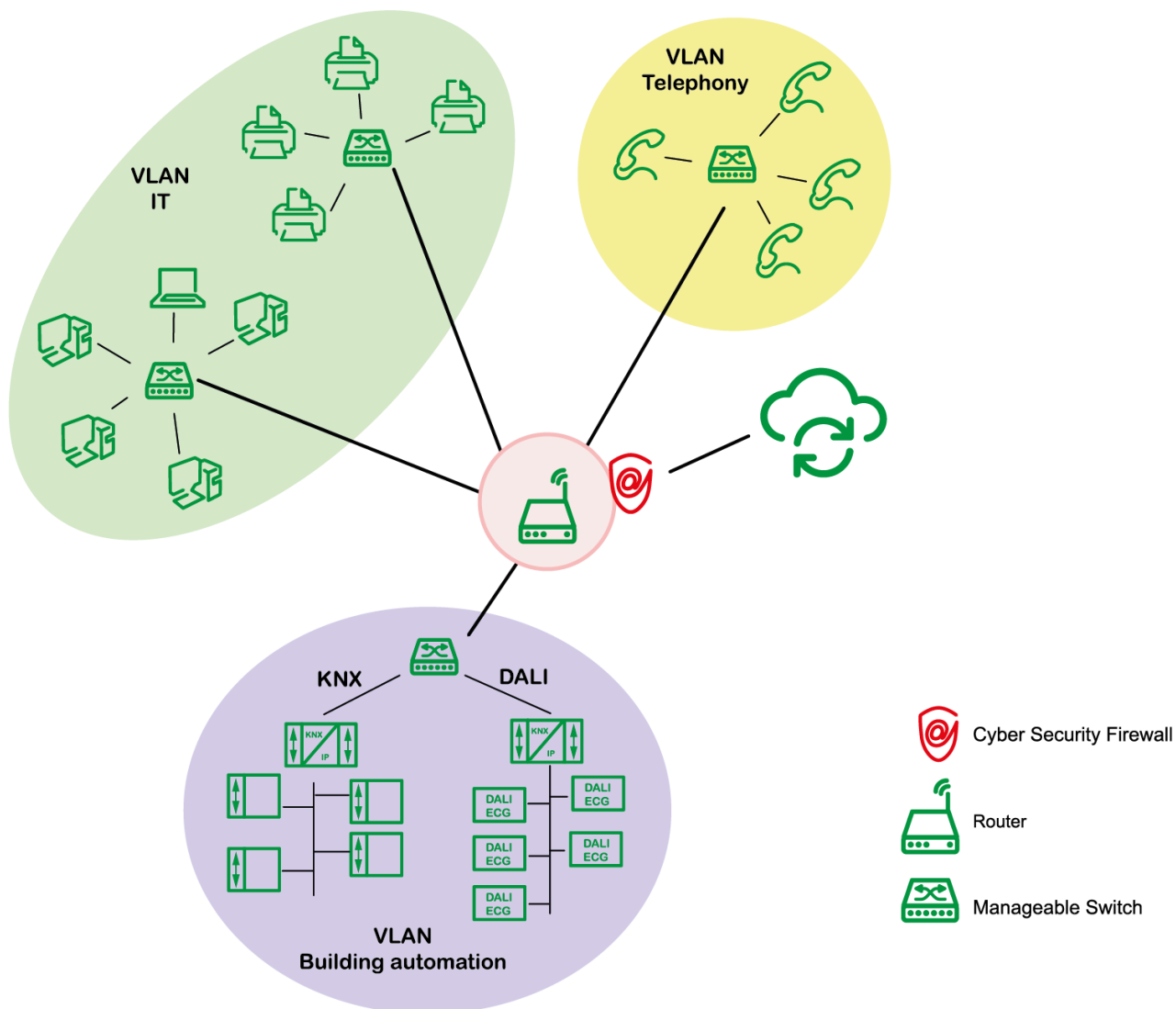

## 22.3 DCA

The DCA does not display the configuration that is visible on the web page.

The data was not synchronized. Please read out the device data, see chapter: [113 DCA Extras](#).

---

## 23 Disclaimer for cyber security

In order to protect plants, systems, machines and networks from online threats, it is necessary to implement a holistic, state-of-the-art security concept and keep it up to date.

You are responsible for preventing unauthorized access to your plants, systems, machines and networks. These should only be connected to a network or the Internet if and to the extent that the connection is necessary and appropriate security measures (e.g. firewalls or [network segmentation](#)) are in place. This is especially very important when using external IoT services, e.g. MQTT brokers.

In addition, the [security recommendations](#) of Schneider Electric must be observed. For further information please contact your contact person at Schneider Electric or visit our website.

Use updates as soon as they are available and always the latest versions. Using versions that are no longer supported or not using the latest updates may increase your risk of online threats. Schneider Electric strongly recommends that you follow security recommendations regarding the latest security threats, patches, and related measures.

## 24 Open Source Software used in the DALI Gateway Pro

The Dali Gateway Pro contains, among other things, Open Source Software files, as specified below, developed by third parties and licensed under an Open Source Software license. These Open Source Software files are protected by copyright. Your right to use the Open Source Software is governed by the relevant applicable Open Source Software license conditions.

Warranty regarding use of the Open Source Software:

The following disclaimer applies to the GPL and LGPL components in relation to the rights holders:

*“these programs are distributed by the copyright holders in the hope that these will be useful, but WITHOUT ANY WARRANTY OF ANY KIND, EITHER EXPRESSED OR IMPLIED, INCLUDING, BUT NOT LIMITED TO, THE IMPLIED WARRANTIES OF MERCHANTABILITY AND FITNESS FOR A PARTICULAR PURPOSE”.* See the GNU General Public License or the GNU Lesser General Public License for more details.

For the remaining open source components, the liability exclusions of the rights holders apply as per the respective license.

Schneider Electric SE and all of its subsidiaries (“Schneider Electric Group”) provide no warranty for the Open Source Software contained in the Dali Gateway Pro, if such Open Source Software is used in any manner other than intended by Schneider Electric Group. The licenses listed below define the warranty, if any, from the rights holders of the Open Source Software. Schneider Electric Group specifically disclaims any warranty for defects caused by altering any Open Source Software or the Dali Gateway Pro's configuration. Any warranty claims against Schneider Electric Group in the event that the Open Source Software contained in the Dali Gateway Pro infringes the intellectual property rights of a third party are excluded.

Technical support, if any, will only be provided for unmodified software.

Further use of Open Source Software:

Your compliance with those license conditions will entitle you to use the Open Source Software as foreseen in the relevant license. In the event of conflicts between other Schneider Electric license conditions applicable to the Dali Gateway Pro and the Open Source Software license conditions, the Open Source Software conditions shall prevail. The Open Source Software is provided royalty-free (i.e. no fees are charged for exercising the licensed rights). The following Open Source Software is contained in this Dali Gateway Pro:

Open Source Software File	License	Source Link
Font Awesome Font Version 4.7.0	SIL OFL Version 1.1	<a href="https://github.com/FortAwesome/Font-Awesome/releases/tag/v4.7.0">https://github.com/FortAwesome/Font-Awesome/releases/tag/v4.7.0</a>
Font Awesome CSS Version 4.7.0	MIT	<a href="https://github.com/FortAwesome/Font-Awesome/releases/tag/v4.7.0">https://github.com/FortAwesome/Font-Awesome/releases/tag/v4.7.0</a>
Bootstrap Version 4.5.0	MIT	<a href="https://github.com/twbs/bootstrap/releases/tag/v4.5.0">https://github.com/twbs/bootstrap/releases/tag/v4.5.0</a>
jquery Version 3.5.1	MIT	<a href="https://github.com/jquery/jquery/releases/tag/3.5.1">https://github.com/jquery/jquery/releases/tag/3.5.1</a>
Mustache 4.0.1	MIT	<a href="https://github.com/janl/mustache.js/releases/tag/v4.0.1">https://github.com/janl/mustache.js/releases/tag/v4.0.1</a>
SweetAlert2 9.14.4	MIT	<a href="https://github.com/sweetalert2/sweetalert2/releases/tag/v9.14.4">https://github.com/sweetalert2/sweetalert2/releases/tag/v9.14.4</a>
Bootstrap Timepicker Version 0.5.2	MIT	<a href="https://github.com/jdewit/bootstrap-timepicker/releases/tag/v0.5.2">https://github.com/jdewit/bootstrap-timepicker/releases/tag/v0.5.2</a>
Jsmn Version 1.0.0	MIT	<a href="https://github.com/zserge/jsmn/releases/tag/v1.0.0">https://github.com/zserge/jsmn/releases/tag/v1.0.0</a>

The respective license terms for the respective Open Source Software files can be found at the end of this document.

If any Open Source Software contained in this Dali Gateway Pro is licensed under GNU General Public License (GPL), GNU Lesser General Public License (LGPL), Mozilla Public License (MPL) or any other Open Source Software license, which requires that source code is to be made available, you can download the corresponding source code of the Open Source Software from the aforementioned link.

=====  
***The Licenses in detail***

#####  
**Font Awesome Font Version 4.7.0**

Copyright (c) 2016 Dave Gandy

**SIL Open Font License Version 1.1 - 26 February 2007**

PREAMBLE

The goals of the Open Font License (OFL) are to stimulate worldwide development of collaborative font projects, to support the font creation efforts of academic and linguistic communities, and to provide a free and open framework in which fonts may be shared and improved in partnership with others.

The OFL allows the licensed fonts to be used, studied, modified and redistributed freely as long as they are not sold by themselves. The fonts, including any derivative works, can be bundled, embedded, redistributed and/or sold with any software provided that any reserved names are not used by derivative works. The fonts and derivatives, however, cannot be released under any other type of license. The requirement for fonts to remain under this license does not apply to any document created using the fonts or their derivatives.

DEFINITIONS

"Font Software" refers to the set of files released by the Copyright Holder(s) under this license and clearly marked as such. This may include source files, build scripts and documentation.

"Reserved Font Name" refers to any names specified as such after the copyright statement(s).

"Original Version" refers to the collection of Font Software components as distributed by the Copyright Holder(s).

"Modified Version" refers to any derivative made by adding to, deleting, or substituting -- in part or in whole -- any of the components of the Original Version, by changing formats or by porting the Font Software to a new environment.

"Author" refers to any designer, engineer, programmer, technical writer or other person who contributed to the Font Software.

PERMISSION & CONDITIONS

Permission is hereby granted, free of charge, to any person obtaining a copy of the Font Software, to use, study, copy, merge, embed, modify, redistribute, and sell modified and unmodified copies of the Font Software, subject to the following conditions:

- 1) Neither the Font Software nor any of its individual components, in Original or Modified Versions, may be sold by itself.

2) Original or Modified Versions of the Font Software may be bundled, redistributed and/or sold with any software, provided that each copy contains the above copyright notice and this license. These can be included either as stand-alone text files, human-readable headers or in the appropriate machine-readable metadata fields within text or binary files as long as those fields can be easily viewed by the user.

3) No Modified Version of the Font Software may use the Reserved Font Name(s) unless explicit written permission is granted by the corresponding Copyright Holder. This restriction only applies to the primary font name as presented to the users.

4) The name(s) of the Copyright Holder(s) or the Author(s) of the Font Software shall not be used to promote, endorse or advertise any Modified Version, except to acknowledge the contribution(s) of the Copyright Holder(s) and the Author(s) or with their explicit written permission.

5) The Font Software, modified or unmodified, in part or in whole, must be distributed entirely under this license, and must not be distributed under any other license. The requirement for fonts to remain under this license does not apply to any document created using the Font Software.

#### TERMINATION

This license becomes null and void if any of the above conditions are not met.

#### DISCLAIMER

THE FONT SOFTWARE IS PROVIDED "AS IS", WITHOUT WARRANTY OF ANY KIND, EXPRESS OR IMPLIED, INCLUDING BUT NOT LIMITED TO ANY WARRANTIES OF MERCHANTABILITY, FITNESS FOR A PARTICULAR PURPOSE AND NONINFRINGEMENT OF COPYRIGHT, PATENT, TRADEMARK, OR OTHER RIGHT. IN NO EVENT SHALL THE COPYRIGHT HOLDER BE LIABLE FOR ANY CLAIM, DAMAGES OR OTHER LIABILITY, INCLUDING ANY GENERAL, SPECIAL, INDIRECT, INCIDENTAL, OR CONSEQUENTIAL

DAMAGES, WHETHER IN AN ACTION OF CONTRACT, TORT OR OTHERWISE, ARISING FROM, OUT OF THE USE OR INABILITY TO USE THE FONT SOFTWARE OR FROM OTHER DEALINGS IN THE FONT SOFTWARE.

#####

#### **Font Awesome CSS Version 4.7.0**

Copyright (c) 2016 Dave Gandy

#### **Bootstrap Version 4.5.0**

Copyright (c) 2011-2020 Twitter, Inc.

Copyright (c) 2011-2020 The Bootstrap Authors

#### **jquery Version 3.5.1**

Copyright (c) JS Foundation and other contributors

#### **Mustache 4.0.1**

Copyright (c) 2009 Chris Wanstrath (Ruby)

Copyright (c) 2010-2014 Jan Lehnardt (JavaScript)

Copyright (c) 2010-2015 The mustache.js community

#### **SweetAlert2 9.14.4**

Copyright (c) 2014 Tristan Edwards & Limon Monte

### **Bootstrap Timepicker Version 0.5.2**

Copyright (c) J.Dewit

### **JSMN Version 1.0.0**

Copyright (c) 2010 Serge A. Zaitsev

### **MIT License**

Permission is hereby granted, free of charge, to any person obtaining a copy of this software and associated documentation files (the "Software"), to deal in the Software without restriction, including without limitation the rights to use, copy, modify, merge, publish, distribute, sublicense, and/or sell copies of the Software, and to permit persons to whom the Software is furnished to do so, subject to the following conditions:

The above copyright notice and this permission notice shall be included in all copies or substantial portions of the Software.

THE SOFTWARE IS PROVIDED "AS IS", WITHOUT WARRANTY OF ANY KIND, EXPRESS OR IMPLIED, INCLUDING BUT NOT LIMITED TO THE WARRANTIES OF MERCHANTABILITY, FITNESS FOR A PARTICULAR PURPOSE AND NONINFRINGEMENT. IN NO EVENT SHALL THE AUTHORS OR COPYRIGHT HOLDERS BE LIABLE FOR ANY CLAIM, DAMAGES OR OTHER LIABILITY, WHETHER IN AN ACTION OF CONTRACT, TORT OR OTHERWISE, ARISING FROM, OUT OF OR IN CONNECTION WITH THE SOFTWARE OR THE USE OR OTHER DEALINGS IN THE SOFTWARE.

## **24.1 Open Source used in Firmware**

All open source software components used within the product are shown on the website, refer to Chapter [6.9 Calling the start page](#)

## 24.2 Open Source used in DCA

---

Package Name: ColorMine - Version: 1.1.3  
<https://www.nuget.org/packages/ColorMine/>  
Copyright(c) 2013 ColorMine.org (MIT-License)

License: MIT  
The MIT License (MIT)

Copyright(c) 2013 ColorMine.org (MIT-License)

Permission is hereby granted, free of charge, to any person obtaining a copy of this software and associated documentation files (the "Software"), to deal in the Software without restriction, including without limitation the rights to use, copy, modify, merge, publish, distribute, sublicense, and/or sell copies of the Software, and to permit persons to whom the Software is furnished to do so, subject to the following conditions:

The above copyright notice and this permission notice shall be included in all copies or substantial portions of the Software.

THE SOFTWARE IS PROVIDED "AS IS", WITHOUT WARRANTY OF ANY KIND, EXPRESS OR IMPLIED, INCLUDING BUT NOT LIMITED TO THE WARRANTIES OF MERCHANTABILITY, FITNESS FOR A PARTICULAR PURPOSE AND NONINFRINGEMENT. IN NO EVENT SHALL THE AUTHORS OR COPYRIGHT HOLDERS BE LIABLE FOR ANY CLAIM, DAMAGES OR OTHER LIABILITY, WHETHER IN AN ACTION OF CONTRACT, TORT OR OTHERWISE, ARISING FROM, OUT OF OR IN CONNECTION WITH THE SOFTWARE OR THE USE OR OTHER DEALINGS IN THE SOFTWARE.

## Schneider Electric Industries SAS

For technical questions please contact the Customer Care Centre in your country.  
[se.com/contact](http://se.com/contact)

© 2023 Schneider Electric, All rights reserved