



Dimming actuator, 4-gang

Art. no. 63961032

Product documentation

Table of contents

| | | |
|-----------|---|-----------|
| 1 | Information on the product | 5 |
| 1.1 | Product catalogue | 5 |
| 1.2 | Function | 5 |
| 1.3 | Device components | 7 |
| 1.4 | Technical data..... | 8 |
| 1.5 | Accessories..... | 9 |
| 2 | Safety instructions | 10 |
| 3 | Mounting and electrical connection | 11 |
| 4 | Troubleshooting | 13 |
| 5 | Commissioning | 16 |
| 6 | Application programs | 18 |
| 7 | Scope of functions | 19 |
| 8 | Notes on software | 21 |
| 9 | Operation and indication | 22 |
| 9.1 | Button operation and indication functions | 22 |
| 9.2 | ETS configuration | 26 |
| 9.2.1 | Manual control..... | 26 |
| 9.2.2 | Status indication | 29 |
| 9.3 | Operation and indication parameters..... | 31 |
| 9.4 | Object list for operation and indication..... | 34 |
| 10 | Dimming operation | 35 |
| 10.1 | Channel configuration | 35 |
| 10.1.1 | Channel configuration parameters | 37 |
| 10.1.2 | Object list for channel configuration | 38 |
| 10.2 | Name of the dimming channel | 39 |
| 10.2.1 | Name of the dimming channel parameters | 40 |
| 10.3 | Defining load type | 41 |
| 10.3.1 | Load type parameter | 44 |
| 10.4 | Operation with power booster | 45 |
| 10.5 | Dimming characteristic..... | 46 |
| 10.5.1 | Parameter Dimming characteristic..... | 52 |
| 10.6 | Brightness range | 54 |
| 10.6.1 | Brightness range parameter..... | 57 |
| 10.7 | Switching/dimming behaviour | 58 |

| | | |
|---------|--|-----|
| 10.7.1 | Switching/dimming behaviour parameters | 61 |
| 10.8 | Central functions | 63 |
| 10.8.1 | General central functions parameter | 65 |
| 10.8.2 | Object list for general central functions | 67 |
| 10.9 | Times | 68 |
| 10.9.1 | General times parameter..... | 68 |
| 10.10 | Reset and initialisation behaviour | 69 |
| 10.10.1 | Reset and initialisation behaviour parameter | 73 |
| 10.11 | Channel-oriented feedback..... | 75 |
| 10.11.1 | Switching status feedback..... | 75 |
| 10.11.2 | Brightness value feedback | 78 |
| 10.11.3 | Short-circuit feedback..... | 80 |
| 10.11.4 | Overload/mains voltage failure feedback | 81 |
| 10.11.5 | Load type feedback..... | 82 |
| 10.11.6 | Feedback telegrams parameter | 84 |
| 10.11.7 | Object list for feedback..... | 88 |
| 10.12 | Collective feedback switching status | 90 |
| 10.12.1 | General collective feedback parameter..... | 92 |
| 10.12.2 | Object list collective feedback | 94 |
| 10.13 | Time delays..... | 95 |
| 10.13.1 | Time delays parameters..... | 96 |
| 10.14 | Switch-on/switch-off behaviour | 97 |
| 10.14.1 | Soft ON/OFF function..... | 97 |
| 10.14.2 | Automatic switch-off | 98 |
| 10.14.3 | Switch-on/switch-off behaviour parameter | 101 |
| 10.15 | Scene function | 103 |
| 10.15.1 | Scene function parameters | 108 |
| 10.15.2 | Object list scene function | 112 |
| 10.16 | Staircase function | 113 |
| 10.16.1 | Staircase function parameters..... | 124 |
| 10.16.2 | Object list staircase function..... | 128 |
| 10.17 | Logic operation function..... | 129 |
| 10.17.1 | Logic operation function parameters | 131 |
| 10.17.2 | Object list logic operation function | 132 |
| 10.18 | Operating hours counter | 133 |
| 10.18.1 | Operating hours counter parameters | 138 |
| 10.18.2 | Object list operating hours counter | 141 |
| 10.19 | Disabling function/Forced position | 143 |

| | | |
|-----------|--|------------|
| 10.19.1 | Disabling function/forced position parameter | 147 |
| 10.19.2 | Object list for disabling function/forced position | 152 |
| 11 | Logic functions..... | 153 |
| 11.1 | Logic functions parameters | 154 |
| 11.2 | Logic gate | 156 |
| 11.2.1 | Logic gate parameters..... | 158 |
| 11.2.2 | Object list for logic gate | 161 |
| 11.3 | Converter (1-bit -> 1-byte)..... | 163 |
| 11.3.1 | Converter parameters | 164 |
| 11.3.2 | Object list for converter | 166 |
| 11.4 | Disabling element (filtering/time)..... | 167 |
| 11.4.1 | Disabling element parameters..... | 169 |
| 11.4.2 | Object list for disabling element | 172 |
| 11.5 | Comparator | 173 |
| 11.5.1 | Comparator parameters | 175 |
| 11.5.2 | Object list for Comparator | 177 |
| 11.6 | Limit value switch | 180 |
| 11.6.1 | Limit value switch parameters | 182 |
| 11.6.2 | Object list for limit value switch | 184 |
| 12 | As-delivered state | 187 |

1 Information on the product

1.1 Product catalogue

| | |
|---------------|--------------------------|
| Product name: | Dimming actuator, 4-gang |
| Use: | Actuator |
| Design: | RMD |
| Order no. | 63961032 |

1.2 Function

The universal dimming actuator works according to the leading edge phase control or trailing edge phase control dimming principle and makes switching and dimming of incandescent lamps, HV halogen lamps and LV halogen lamps possible by means of conventional transformers and Tronic transformers, and dimmable HV LEDs and LV LEDs by means of electronic or conventional transformers or compact fluorescent lamps.

The characteristic of the connected load - provided that the load is supported - can be automatically measured separately for each output channel and the appropriate dimming procedure can be set. Alternatively, it is possible to predefine the dimming procedure using the ETS configuration. This procedure is necessary for loads that do not enable automatic calibration (e.g. with compact fluorescent lamps). 4 dimming channels are available. To simplify the configuration, all existing dimming channels can be assigned to the same parameters in the ETS and thus configured identically. The number of parameters is thereby reduced in the ETS and applied automatically on all channels.

To increase the channel power, outputs can be wired in parallel by reducing the number of channels (not with compact fluorescent lamps). The assignment of parallel to wired dimming outputs to the KNX-controllable dimming channels takes place in the ETS.

The device permits the separate feedback of the individual switching and brightness statuses of the connected loads to the KNX. Moreover, a short-circuit and load failure can be signalled separately to the KNX for each dimming channel.

The pushbuttons on the front panel of the device allow the dimming channels to be switched on or dimmed by manual operation in parallel with the KNX in a non-programmed state. This feature permits fast checking of connected loads for proper functioning.

The function features that are independently adjustable for every dimming channel by means of the ETS include, for example, separately configurable brightness ranges, extended feedback functions, a disabling function, or alternatively, a forced position function, a logic operation function, separately adjustable dimming behaviour, soft dimming functions, time delays and a staircase function with pre-warning before switching off the lighting.

Furthermore, each dimming channel can be integrated in up to 64 scenes with various brightness values. Central switching of all channels is possible, too. Moreover, the brightness values of the dimming channels in case of a bus voltage failure or when the bus voltage returns and after ETS programming, can be set separately.

The switch-on times of the dimming channels can be detected and evaluated separately by operating hours counters.

In addition to dimming operation, the device has 8 internal logic functions. Using these functions, logic gates (e.g. AND, OR, exclusive AND, exclusive OR, each with up to 4 inputs) can be set up and thus switching and status information can be linked and evaluated. Alternatively, a 1-bit to 1-byte converter and a disabling element with filter and time functions can be configured for each logic function. As a further option, comparators or limit value switches with hysteresis can be set as logic functions. The logic functions have their own KNX communication objects and can process telegrams from the actuator or other bus devices.

The device can be updated. Firmware can be easily updated with the Insta ETS Service app (additional software).

The device is KNX Data Secure capable. KNX Data Secure offers protection against manipulation in building automation and can be configured in the ETS project. Detailed technical knowledge is a prerequisite. A device certificate, which is attached to the device, is required for safe commissioning. During mounting, the certificate must be removed from the device and stored securely.

Planning, installation and commissioning of the device are carried out with the aid of the ETS, version 5.7.3 and above or of the ETS6.

The device electronics are supplied exclusively from the bus voltage. The device is designed for mounting on DIN-rails in closed compact boxes or in power distributors in fixed mounting in dry rooms.

1.3 Device components

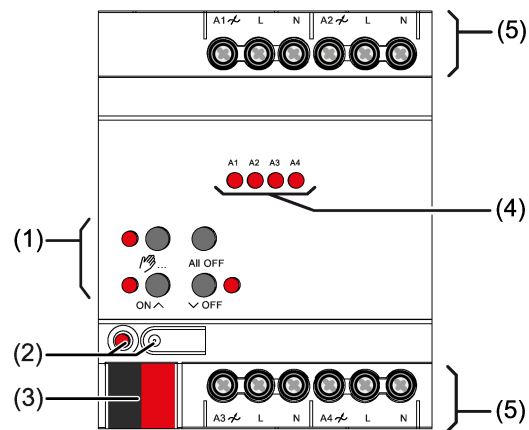





Figure 1: Device components

- (1) Button field for manual control
- (2) Programming button and LED
- (3) KNX connection
- (4) Status LEDs for outputs
- (5) Load connections

1.4 Technical data

| | |
|-------------------------------|----------------------------|
| Rated voltage | AC 110 ... 230 V ~ |
| Mains frequency | 50 / 60 Hz |
| Power loss | max. 7 W |
| Standby power | approx. 0.16 W per channel |
| Ambient temperature | -5 ... +45 °C |
| Storage/transport temperature | -25 ... +70 °C |

Connected load per channel depends on the connected lamps and the set load type:
(see figure 2), (see figure 3)

| | |
|--|---|
| | ETS parameter load type |
| UNI | Universal (with automatic calibration procedure) |
|  | conv. transformer (inductive / leading edge phase control) |
| LED  | LED (leading edge phase control) |
|  | electronic transformer (capacitive / trailing edge phase control) |
| LED  | LED (trailing edge phase control) |











| |  LED |  LED |  LED |
|--|--|---|--|
| 230V | | | |
| | W | W | VA |
| UNI | 1 ... 35 | 20 ... 100 | 20 ... 100 |
|  | — | — | 20 ... 100 |
| LED  | 1 ... 35 | 20 ... 100 | — |
|  | 1 ... 200 | 20 ... 200 | — |
| LED  | 1 ... 200 | 20 ... 200 | — |
| 110V | | | |
| | W | W | VA |
| UNI | 1 ... 18 | 20 ... 50 | 20 ... 50 |
|  | — | — | 20 ... 50 |
| LED  | 1 ... 18 | 20 ... 50 | — |
|  | 1 ... 100 | 20 ... 100 | — |
| LED  | 1 ... 100 | 20 ... 100 | — |

Figure 2: LED lamp loads









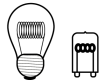
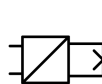

| |  |  |  |  |
|---|---|---|--|---|
| 230V | | | | |
| | W | W | VA | W |
| UNI | 20 ... 225 | 20 ... 210 | 20 ... 210 | 20 ... 80 |
|  | 20 ... 210 | — | 20 ... 210 | — |
| LED  | 20 ... 210 | 20 ... 210 | — | 20 ... 80 |
|  | 20 ... 225 | 20 ... 225 | — | 20 ... 150 |
| LED  | 20 ... 225 | 20 ... 225 | — | 20 ... 150 |
| 110V | | | | |
| | W | W | VA | W |
| UNI | 20 ... 120 | 20 ... 110 | 20 ... 110 | 20 ... 40 |
|  | 20 ... 110 | — | 20 ... 110 | — |
| LED  | 20 ... 110 | 20 ... 110 | — | 20 ... 40 |
|  | 20 ... 120 | 20 ... 120 | — | 20 ... 75 |
| LED  | 20 ... 120 | 20 ... 120 | — | 20 ... 75 |

Figure 3: conventional lamp loads

i Capacitive-inductive mixed load is not permitted

Power boosters

See power booster instructions

Connection

Single stranded

0.5 ... 4 mm²

Finely stranded without conductor sleeve

0.5 ... 4 mm²

Finely stranded with conductor sleeve

0.5 ... 2.5 mm²

Connection torque for screw terminals

max. 0.8 Nm

Installation width

72 mm / 4 HP

KNX

KNX medium

TP256

Commissioning mode

S mode

Rated voltage KNX

DC 21 ... 32 V SELV

Current consumption KNX

6 ... 15 mA

Connection mode KNX

Device connection terminal

1.5 Accessories

Compensation module LED

Art. no. 51681001

2 Safety instructions

To avoid potential damage, read and follow the following instructions:



Electrical devices may be mounted and connected only by electrically skilled persons.

Danger of electric shock. Device is not suitable for disconnection from supply voltage because mains potential even is applied on the load when the output is switched off. Always disconnect before carrying out work on the device or load. To do so, switch off all associated circuit breakers.

Risk of destruction of the dimmer and load if the set operation and load type do not match. Set the correct dimming principle before connecting or exchanging the load.

Fire hazard. For operation with inductive transformers, each transformer must be fused on the primary side in accordance with the manufacturer's instructions. Only safety transformers according to EN 61558-2-6 (VDE 0570 parts 2-6) may be used.

Danger of electric shock. Always disconnect before carrying out work on the device or load. In so doing, take all the circuit breakers into account, which support dangerous voltages to the device and or load.

Instructions are part of the product. So keep them in a safe place.

3 Mounting and electrical connection



DANGER!

Electric shock when live parts are touched.

Electric shocks can be fatal.

Always disconnect before carrying out work on the device or load. To do so, switch off all corresponding circuit breakers, secure them against being switched on again and check that there is no voltage. Cover up any adjacent live parts.

Mount device

In secure operation (prerequisites):

- Secure commissioning has been activated in the ETS.
- Device certificate entered/scanned or added to the ETS project. A high resolution camera should be used to scan the QR code.
- Document all passwords and keep them safe.

Observe the ambient temperature. Ensure sufficient cooling.

Maintain a distance of 18 mm, 1 HP when operating multiple dimmers or power units within the same control cabinet.

- Mount device on DIN rail.
- In secure operation: The device certificate must be removed from the device and stored securely.

Connect device

- Connect bus line with KNX device connection terminal observing the correct polarity.
 - Attach the cover cap to the KNX connection as protection against hazardous voltages.
-



CAUTION!

Danger of destruction. 400 V are shorted when outputs switched in parallel are connected to different outer phase conductors.

The device will be destroyed.

Always connect outputs switched in parallel to the same outer phase conductor.

- i** Delivery state: The outputs can be operated in manual control.

In the "Universal" operation, the dimming actuator only calibrates itself again after disconnection of the load and also after commissioning using the ETS.

- i** Capacitive-inductive mixed load is not permitted

- i** For LED leading edge phase control: Connect a maximum of 2 electronic transformers per output.
- i** Connect the 600 W LED lamps or compact fluorescent lamps at most for each 16 A circuit breaker. When connecting transformers, observe the data of the transformer manufacturer.
- i** Several dimmer outputs can be combined for dimming greater lamp loads. Only utilise parallel-switched outputs up to 95 % each. Do not connect any compact fluorescent lamps to dimmer outputs switched in parallel.
- i** Observe delivery state. Before connecting parallel outputs and switching on, program the dimming actuator with ETS to the changed output configuration.
- i** Do not expand parallel-switched dimmer outputs with power packs.

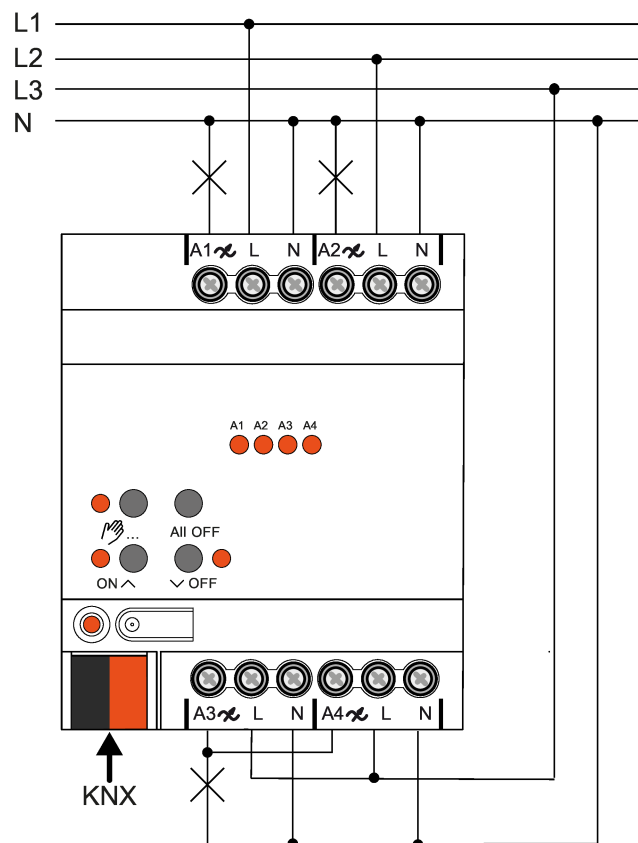

Figure 4: Comfort variant of the device connection with dimmer outputs switched in parallel (connection example)

- Connect the lamp loads according to the connection example.

4 Troubleshooting

Connected LED lamps or compact fluorescent lamps switch off in the lowest dimming position or flicker

The set minimum brightness is too low.

Increase the minimum brightness.

Connected LED lamps or compact fluorescent lamps flicker

Cause 1: Lamps are not dimmable.

Check manufacturer's instructions.

Exchange lamps for another type.

Cause 2: Dimming principle and lamps do not match optimally.

For HV-LED: Check operation in another dimming principle, reduce connected load as well if necessary.

For LV-LED: Check the lamp operating device and replace as necessary.

With the "Universal" setting: Define the dimming principle manually.

Connected HV-LED lamps or compact fluorescent lamps in the lowest dimming position are too bright; dimming range is too small

Cause 1: The set minimum brightness is too high.

Reduce the minimum brightness.

Cause 2: HV-LED trailing edge phase control dimming principle does not optimally match the connected lamps.

Check operation in the "HV-LED leading edge phase control" setting, reduce connected load as well if necessary.

Exchange lamps for another type.

Output has switched off

Cause 1: Overheating protection has tripped.

Disconnect all outputs from the mains, switch-off the corresponding circuit breakers.

LED trailing edge phase control: Reduce the connected load. Exchange lamps for another type.

LED leading edge phase control: Reduce the connected load. Check the operation in the "HV-LED trailing edge phase control" setting. Exchange lamps for another type.

Let device cool down for at least 15 minutes. Check installation situation, ensure cooling, e.g. provide distance from surrounding devices.

Cause 2: Overvoltage protection has tripped.

LED trailing edge phase control: Check operation in the "HV LED leading edge phase control" setting, reduce connected load as well if necessary.

Exchange lamps for another type.

- i** The response of the surge protection can be signalled by sending a short-circuit telegram or can be determined by polling the "Short-circuit" communication object.

Cause 3: short-circuit in output circuit

Disconnect all outputs from the mains.

Rectify the short-circuit.

Switch on mains voltage to the outputs again. Switch the affected output off and on again.

- i** When a short-circuit occurs the affected output switches off. Automatic restart when short-circuit is eliminated within 100 ms (inductive load) or 7 seconds (capacitive or ohmic load). After that lasting switch-off.
- i** When a short-circuit occurs during the calibration process, the load calibrates itself again after the short-circuit is eliminated.

Cause 4: load failure.

Check load, replace lamp. For inductive transformers, check primary fuse and replace if necessary.

Manual control with button field not possible

Cause 1: Manual control has not been programmed.

Program manual control.

Cause 2: Manual control via bus disabled.

Enable manual control.

None of the outputs can be operated

Cause 1: All of the outputs are disabled.

Cancel disabling.

Cause 2: Manual operation active.

Deactivate manual operation (switch off continuous manual operation).

Cause 3: Application software missing or faulty.

Check and correct the programming.

All outputs off and not possible to switch on

Cause 1: bus voltage failure.

Check bus voltage.

Luminaires flicker or buzz, proper dimming not possible, device buzzes

Cause: wrong dimming principle set.

Installation or commissioning error. Disconnect device and luminaire, switch off circuit breaker.

Check installation and correct.

If the wrong dimming principle has been preselected: Set correct dimming principle.

If dimming actuator calibrates itself incorrectly, e.g. with highly inductive mains or long load cables: preselect correct dimming principle with commissioning.

LED lamp is dimly lit when dimmer is switched off

Cause: LED lamp is not optimally suited to this dimmer.

Use a compensation module, see accessories.

Use another type of LED lamp or an LED lamp of another manufacturer.

5 Commissioning

Loading the physical address and application program

- Press the programming button.
The programming LED lights up.
- Load the physical address and application program with the ETS.

Master reset

The master reset restores the basic device settings (physical address 15.15.255, firmware remains in place). The device must then be recommissioned with the ETS. Manual control is possible.

In secure operation: A master reset deactivates device security. The device can then be recommissioned with the device certificate.

Performing a master reset

Precondition: The safe-state mode is activated.

- Press and hold down the programming button for > 5 s.

The programming LED flashes quickly.

The device performs a master reset, restarts and is ready for operation again after approx. 5 s.

Safe-state mode

The safe-state mode stops the execution of the loaded application program.

- i** Only the system software of the device is still functional. ETS diagnosis functions and programming of the device are possible. Manual control is not possible.

Activating safe-state mode

- Switch off the bus voltage or remove the KNX device connection terminal.
- Wait approx. 15 s.
- Press and hold down the programming button.
- Switch on the bus voltage or attach the KNX device connection terminal. Release the programming button only after the programming LED starts flashing slowly.

Safe-state mode is activated.

The programming mode can also be switched on and off in the safe-state mode as usual by briefly pressing the programming button again. The programming LED stops flashing if the programming mode is active.

Deactivating safe-state mode

- Switch off bus voltage (wait approx. 15 s) or carry out ETS programming.

6 Application programs

| | |
|------------------------|---|
| ETS search paths: | Illumination / Dimmer / Dimming actuator RMD |
| Name | Dimming 303023 |
| Version | 2.4 |
| from mask version | for ETS5 from Version 5.7.3 onwards and ETS6 SystemB (07B0) |
| Summarized description | Multifunctional dimming application with logic functions and manual control. KNX Data Secure capable. |

7 Scope of functions

General

- To increase the channel power, outputs can be wired in parallel by reducing the number of channels. The assignment of parallel to wired dimming outputs to the KNX-controllable dimming channels takes place in the ETS.
- To simplify the configuration, all existing dimming channels can be assigned to the same parameters in the ETS and thus configured identically.
- Up to 6 central functions for collective control of all dimming channels with switching, dimming and value objects.
- Up to 8 independent logic functions for the implementation of simple or complex logic operations.
- Actively transmitting feedback or status messages can be delayed globally after the bus voltage returns or after ETS programming.
- Manual operation of outputs independent of the KNX (for instance, construction site mode) with LED status indicators. Separate status feedback to the KNX for manual operation. Manual control can also be disabled via the bus.

Dimming outputs

- Independent switching and dimming of the dimming outputs.
- Central control function with up to 6 switching objects, 6 dimming objects and 6 value objects and collective feedback.
- Switching feedback mode: Active (transmitting after changes or cyclically to the bus) or passive (object readout) feedback function.
- Reaction in case of a bus voltage failure and when the bus voltage returns as well as after ETS programming can be set for each output.
- Logic function individual for each output.
- Disabling function can be parameterized for each channel. Forced position function separately for each output as an alternative.
- Timing functions (switch-on delay, switch-off delay, staircase lighting timer, also with pre-warning function).
- Incorporation into light moods: up to 64 internal scenes parameterizable per output.
- Operating hours counter can be activated independently for each output.

Logic functions

- The device has 8 internal logic functions in addition to the dimming operation.
- Logic gates (e.g. AND, OR, exclusive AND, exclusive OR, each with up to 4 inputs).
- 1-bit to 1-byte converter with input filter, disabling object and presetting of the output values.
- Disabling element with filter and time functions and disabling object.

- Comparator for values with 9 different input data formats and many comparison operations.
- Limit switch with hysteresis with upper and lower threshold for 9 different input data formats. Incl. presetting of the 1-bit output values.
- The logic functions have their own KNX communication objects and can process telegrams of the actuator or of other bus devices.

8 Notes on software

Unloading the application program

The application program can be unloaded with the ETS. In this case the device is without function. Manual operation is no longer possible.

ETS project design and commissioning

For project design and commissioning of the device, ETS5 from Version 5.7.3 onwards or ETS6 is required. Project designing and commissioning of the device using ETS2, ETS3 or ET4 is not possible.

9 Operation and indication

9.1 Button operation and indication functions

Operating elements

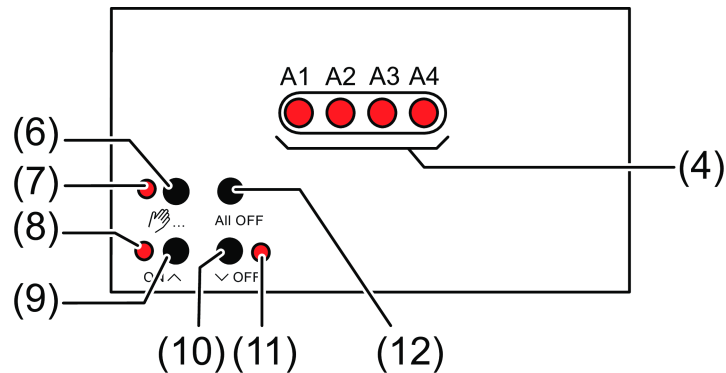

Figure 5: Operating elements

- (4) Status LEDs for outputs
 - on: output switched on, 1...100%
 - flashes at 1 Hz: short-circuit or manual operation
 - flashes at 2 Hz: overload, mains voltage failure or firmware update
- (6) Button
 - Manual control
- (7) LED
 - on: continuous manual operation
- (8) LED **ON**
 - on: selected output on, 1...100%
 - flashes: Firmware update
- (9) Button **ON**
 - Switch on/increase brightness
- (10) Button **OFF**
 - Switch off/reduce brightness
- (11) LED **OFF**
 - on: Selected output off
 - flashes: Firmware update
- (12) Button **ALL OFF**
 - Switching off all outputs

Operating modes

- Bus operation: operation via push-button sensors or other bus devices
- Temporary manual operation: manual control locally with keypad, automatic return to bus control
- Continuous manual operation: exclusively manual control on the device

- i** No bus operation is possible in manual operation.
- i** After a bus failure and restoration the device switches to bus operation.
- i** The manual operation can be disabled in ongoing operation via a bus telegram.

Switching on temporary manual operation

Operation using the button field is programmed and not disabled.

- Press the button ... (6) briefly.

LED ... (7) flashes, LED A1... (4) of the first configured output flashes.

Short-time manual operation is switched on.

After 5 s without a button actuation, the actuator returns automatically to bus operation.

Switching off temporary manual operation

The device is in short-term manual operation.

- No button-press for 5 s.

- or -

- Press ... (6) button briefly as many time as necessary until the actuator leaves the short-time manual operation.

Status LED A1... (4) no longer flash, but rather indicate the output status.

Short-time manual operation is switched off.

When switching off the manual control, the outputs, depending on the programming, switch to the active position, e.g. restraint, logic operation.

Switching on permanent manual operation

Operation using the button field is programmed and not disabled.

- Press the ... (6) button for at least 5 s.

LED ... (7) lights, LED A1... (4) of the first configured output flashes.

Continuous manual operation is switched on.

Switching off permanent manual operation

The device is in permanent manual operation.

- Press the ... (6) button for at least 5 s.

LED ... (7) is off.

Continuous manual operation is switched off. Bus operation is switched on.

When switching off the manual control, the outputs, depending on the programming, switch to the active position, e.g. restraint, logic operation.



Operating the outputs

The device is in permanent or temporary manual operation.

- Press the button ... (6) briefly as many times as necessary until the desired output is selected.

The LED of the selected output A1... (4) flashes.

The LEDs **ON**  (8) and  **OFF** (11) indicate the status.

- Operate output with **ON**  (9) button or  **OFF** (10) button.
Short: switch on/off.
Long: dim brighter/darker.
Release: Stop dimming.

The LEDs **ON**  (8) and  **OFF** (11) indicate the status.

- i** Short-term manual operation: After running through all of the outputs the device exits manual operation after another brief actuation.

Switching off all outputs



The device is in permanent manual operation.

- Press the **ALL OFF** button.

All outputs are switched off.

Disabling outputs

The device is in permanent manual operation. The bus control can be disabled (ETS parameter).

- Press the button ... (6) repeatedly until the LED A1... (4) of the desired output flashes.
- Press the **ON**  (9) and  **OFF** (10) buttons simultaneously for approx. 5 s.



Selected output is disabled.

The status LED A1... (4) of the selected output flashes quickly.

- i** A disabled output can be operated in manual operation.

Re-enabling outputs

The device is in permanent manual operation. One or more outputs were disabled in manual operation.

- Press the button ... (6) repeatedly until the output to be unlocked is selected.
- Press the **ON**  (9) and  **OFF** (10) buttons simultaneously for approx. 5 s.

Disabling is deactivated.

LED A1... (4) of the selected output flashes slowly.

9.2 ETS configuration

9.2.1 Manual control

All outputs of the device have electronic manual operation. The button field with 4 function buttons and 3 status LEDs on the front panel of the device can be used for setting the following modes of operation:

- Bus operation: operation via push-button sensors or other bus devices
- Temporary manual operation mode: manual operation locally with button field, automatic return to bus operation
- Permanent manual operation mode: local manual operation with keypad

Manual operation is possible while the device is supplied with power from the bus supply voltage. In the as-delivered state, manual operation is fully enabled. In this un-programmed state, all outputs can be controlled by the manual operation so that fast function checking of the connected loads (e.g. on the construction site) is possible.

After initial commissioning of the actuator via the ETS, manual operation can be enabled or completely disabled.

Disabling manual operation permanently

Manual operation is enabled in the as-delivered state. If the parameter of the same name is deactivated on the "Manual operation" parameter page, no parameters and communication objects for manual operation are available. The outputs can then only be controlled via the bus.

In the case of a temporary status indication, the status LEDs continue to indicate the status of the outputs when the "Manual operation" button is pressed.

Disabling manual operation temporarily

Manual operation can be separately disabled via the bus, even if it is already active. If the disabling function is enabled, then as soon as a disabling telegram is received via the disabling object, the actuator immediately terminates any activated manual operation and locks the function keys on the front panel of the device. The telegram polarity of the disabling object can be configured.

Manual operation must be enabled.

- Activate the parameter "Disabling function" on the "Manual operation" parameter page.

The disabling function of manual operation is enabled and the disabling object becomes visible.

- Select the desired telegram polarity in the parameter "Polarity of the disabling object".

- i** If the polarity is "0 = disabled; 1 = enabled", the disabling function is immediately active after the bus voltage returns or after an ETS programming operation (object value "OFF"). To activate manual operation in this case, an enable telegram "ON" must first be sent to the disabling object.
- i** After bus voltage return, a disabled state that was active beforehand is always inactive when the polarity of the disabling object is non-inverted.
- i** When an active manual operation is terminated by a disable, the actuator will also transmit a "Manual operation inactive" status telegram to the bus, if the status messaging function is enabled.

Presetting the behaviour at the beginning and at the end of manual operation

Manual operation distinguishes between the temporary and permanent manual operation modes. The behaviour is different depending on these operating modes, especially at the end of manual operation. It should be noted that the operation via the bus, i.e. control of the outputs by direct operation (switching / dimming / brightness value, scenes, central) or by the disabling or forced position functions is always disabled when the manual control is active. This means that manual operation has the highest priority.

Behaviour at the beginning of manual operation:

The behaviour at the beginning of manual operation does not differ for temporary and permanent manual operation modes. During activation of the manual operation, the brightness statuses of the dimming channels remain unchanged. Flashing during disabling function feature: The flashing of a disabling function is interrupted at the beginning of a manual operation. The brightness adapts itself to the switch-on brightness. The switching status is indicated as "ON". Active forced position functions or disabling functions can be overridden by manual control. These functions are reactivated after deactivation of the manual mode unless they have been cancelled via the bus in the meantime.

Behaviour at the end of manual operation:

The behaviour at the end of manual operation is different for temporary and permanent manual operation modes. The temporary manual operation mode is shut off automatically when the last output has been addressed and when the selection button  is pressed once more. During deactivation of the temporary manual operation mode, the actuator returns to 'normal' bus operation and does not change the brightness states selected by manual control.

The permanent manual operation mode is shut off when the selection button  is pressed for more than 5 seconds. Depending on the parameterization of the actuator in the ETS, the outputs will be set to the state last adjusted in the manual mode or to the state internally tracked (direct operation, forced position, disabling) when the permanent manual mode is switched off. The parameter "End of permanent manual control" defines the corresponding reaction.

- Set the parameter "End of permanent manual control" to "No change".

All telegrams received during an active permanent manual control mode for direct operation (switching, dimming, brightness value, central, scenes) will be rejected. After the end of the permanent manual control mode, the current

brightness state of all the channels remains unchanged. If, however, a forced position or disabling function has been activated via KNX before or during manual operation, the actuator executes these functions of a higher priority again for the channels concerned.

- Set the parameter "End of permanent manual control" to "Track outputs".

During active permanent manual operation, all incoming telegrams are tracked internally. At the end of manual operation, the channels are set to the last tracked brightness states. If a forced position or disabling function has been activated via KNX before or during manual operation, the actuator executes these functions of a higher priority again for the channels concerned.

Setting the status message function for manual operation

An actuator can transmit a status telegram to the KNX via a separate object when the manual operation is activated or deactivated. The status telegram can only be transmitted when the bus voltage is switched on. The polarity of the status telegram can be parameterised.

Manual operation must be enabled.

- Activate the parameter "Status" on the "Manual control" parameter page.

The status messaging function of manual operation is enabled and the status object is visible.

- Specify in the parameter "Status object function and polarity" whether the status telegram is generally a "ON" telegram whenever the manual control mode is activated or only in those cases where the permanent manual mode is activated.

i The status object is always "0" when the manual control mode is deactivated.

i The "Inactive" status is transmitted automatically to the bus after the bus voltage returns or an ETS programming operation.

i When active manual operation is terminated by a disable, the actuator will also transmit a "Manual operation inactive" status telegram to the bus.

Setting disabling of the bus control

Individual dimming channels can be disabled locally by manual operation on the device so that the connected loads can no longer be controlled via the KNX. Such disabling of the bus operation is initiated by operation in permanent manual operation mode and is indicated by rapid flashing of the status LEDs on the front panel of the device. The disabled outputs can then only be activated in permanent manual operation.

Manual operation must be enabled.

- Activate the parameter "Disable bus control of individual outputs" on the parameter page "Manual operation".

The function for disabling the bus control is enabled and can be activated locally. Alternatively, deactivating the parameter prevents disabling of the bus control from being activated in permanent manual operation mode.

- i** The disabling initiated locally has the highest priority. Thus all other functions of the actuator that can be activated via KNX (e.g. forced position or disabling function) are overridden. The bus-disabled output remains in the state last set in permanent manual operation mode.
Depending on the parameterization of the actuator in the ETS, the groups will be set to the state last adjusted in the manual mode or to the state internally tracked (direct operation, forced position, disabling) when the permanent manual mode is reactivated and subsequently shut off.
- i** The disabling function of manual operation does not influence bus-disabled outputs.
- i** A failure of the bus voltage or an ETS programming operation deactivates disabling of the bus control.

9.2.2 Status indication

The status LEDs on the front of the device can indicate the current status of the dimming channels permanently or temporarily.

- Continuous status indication:
The parameter "Indicate status temporarily" on the "Status indication" parameter page is deactivated. In the case of a continuous status indication, the status LEDs always indicate the current status of the outputs.
- Temporary status indication:
The parameter "Indicate status temporarily" on the "Status indication" parameter page is activated. During temporary indication, the status indication is activated by pressing the "Manual operation" button. The display length is set in the ETS.
If manual operation is enabled in the ETS, pressing the "Manual operation" button also activates the temporary or permanent manual operation mode. The status indication always remains active during manual operation. At the end of manual operation mode, the display length of the temporary status indication is restarted. The status LEDs then go out after the configured time has elapsed.
If manual operation is not enabled in the ETS, all status LEDs only show the status of the outputs when the "Manual operation" button is pressed, depending on the duration of the display.

- i** In the as-delivered state, the continuous status indication is preset.

If the parameter "Control via object" is activated, the "Temporary status indication" communication object is available in the ETS. This object is bidirectional and can firstly signal the status of the temporary status indication, and secondly, activate the status display. If a temporary status indication has been activated by pressing the "Manual operation" button, the object transmits the value "ON". If the object receives

a telegram with the value "OFF" or "ON", the status LEDs indicate the status of the outputs according to the display length. Manual operation is not activated in this case.

By linking the "Temporary status indication" objects of several actuators using a common group address, the indication functions of the status LED can be synchronized with one another. It is thus possible to activate the status indications of all actuators in a control cabinet at the same time if manual operation is triggered on one actuator only - e. g. for service or maintenance purposes.

In addition, the "Temporary status display" object could be controlled, for example, by a magnetic contact connected to the KNX, so that the status indications of all actuators are activated by opening the control cabinet door. If the door is closed, the status indications for energy saving remain switched off.

- i During a running display length, the "Temporary status indication" object does not transmit any new telegrams if the "Manual operation" button is pressed again.

9.3 Operation and indication parameters

Manual control

| | |
|---|---------------------|
| Manual control | Checkbox (yes / no) |
| Manual operation is possible while the device is supplied with power from the bus supply voltage. This parameter defines whether manual operation is to be possible or deactivated permanently. | |

| | |
|---|---------------------|
| Disabling function | Checkbox (yes / no) |
| Manual operation can be disabled via the KNX, even if it is already active. For this purpose, the disabling object can be enabled here. This parameter is only visible if manual operation is enabled. | |

| | |
|---|--|
| Polarity of the locking object | 0 = enabled; 1 = disabled 0 = disabled; 1 = enabled |
| This parameter sets the polarity of the disabling object. This parameter is only visible if the disabling function is enabled. | |

| | |
|--|---------------------|
| Status | Checkbox (yes / no) |
| An actuator can transmit a status telegram to the KNX via a separate object when the manual operation is activated or deactivated. This parameter is only visible if manual operation is enabled. | |

| | |
|--|--|
| Status object function and polarity | 0 = inactive; 1 = manual operation active 0 = inactive; 1 = permanent manual operation active |
| This parameter defines the information contained in the status object. The object is always "OFF" when manual operation is deactivated. 0 = inactive; 1 = manual operation active: The object is "ON" when manual operation is active (temporary or permanent). 0 = inactive; 1 = permanent manual operation active: The object is only "ON" when permanent manual operation is active. This parameter is only visible if the status function is enabled. | |

| | |
|--|------------------------------|
| End of permanent manual control | no change Output tracking |
| <p>The behaviour of the actuator at the end of permanent manual operation depends on this parameter. This parameter is only visible if manual operation is enabled.</p> <p>No change: all telegrams received during an active permanent manual control mode for direct operation (switching, dimming, brightness value, scenes) will be rejected. After the end of the permanent manual operation, the current state of all outputs which was most recently active in manual operation remains unchanged. If, however, a forced position or disabling function has been activated via the KNX before or during manual operation, the actuator executes these functions of a higher priority again for the dimming channels concerned.</p> <p>Track outputs: during active permanent manual operation, all incoming telegrams and state changes are tracked internally. At the end of manual operation, the channels are set to the last tracked brightness states. If a forced position or disabling function has been activated via KNX before or during manual operation, the actuator executes these functions of a higher priority again for the channels concerned.</p> <p>This parameter is only visible if manual operation is enabled.</p> | |

| | |
|---|---------------------|
| Bus control of individual outputs can be disabled | Checkbox (yes / no) |
| <p>Individual outputs can be disabled locally during permanent manual operation, so that the disabled outputs can no longer be controlled via the KNX. Disabling via manual operation is only permitted if this parameter is activated.</p> <p>This parameter is only visible if manual operation is enabled.</p> | |

Status indication

| | |
|---|---------------------|
| Indicating status temporarily | Checkbox (yes / no) |
| <p>The status LEDs on the front of the device can indicate the current status of the dimming channels permanently or temporarily.</p> <p>Parameter deactivated: Continuous status indication. In this case, the status LEDs always indicate the current status of the outputs.</p> <p>Parameter activated: Temporary status indication. In this case, the status indication is activated by pressing the "Manual operation" button. The display length is set in the ETS. If manual operation is enabled in the ETS, pressing the "Manual operation" button also activates the temporary or permanent manual operation mode. The status indication always remains active during manual operation. At the end of manual operation mode, the display length of the temporary status indication is restarted. The status LEDs then go out after the configured time has elapsed.</p> | |

| | |
|---|------------------|
| Display length (6...255) | 6 ... 10 ... 255 |
| <p>This parameter defines the display length if the temporary status indication is activated.</p> | |

| Control via object | Checkbox (yes / no) |
|--|---------------------|
| <p>If the parameter "Control via object" is activated, the "Temporary status indication" communication object is available in the ETS. This object is bidirectional and can firstly signal the status of the temporary status indication, and secondly, activate the status display. If a temporary status indication has been activated by pressing the "Manual operation" button, the object transmits the value "ON". If the object receives a telegram with the value "OFF" or "ON", the status LEDs indicate the status of the outputs according to the display length. Manual operation is not activated in this case.</p> | |

9.4 Object list for operation and indication

| Object no. | Function | Name | Type | DPT | Flag |
|--|-----------------------------|---------------------------------|-------|-------|-----------------|
| 1 | Disabling | Manual operation - Input | 1-bit | 1,003 | C, (R), W, -, A |
| 1-bit object for disabling manual operation on the device. The polarity can be configured. | | | | | |
| Object no. | Function | Name | Type | DPT | Flag |
| 2 | Status | Manual operation - Output | 1-bit | 1,002 | C, R, -, T, A |
| 1-bit object for manual operation status transmission. The object is "OFF" when manual operation is deactivated (bus control). The object is "ON" when manual operation is activated. You can configure whether temporary or permanent manual operation will be indicated as status information or not. | | | | | |
| Object no. | Function | Name | Type | DPT | Flag |
| 3 | Temporary status indication | Manual operation - Input/Output | 1-bit | 1,017 | C, (R), W, T, A |
| 1-bit object to signal and activate the temporary status indication. This object is bidirectional and can firstly signal the status of the temporary status indication, and secondly, activate the status display. If a temporary status indication has been activated by pressing the "Manual operation" button, the object transmits the value "ON". If the object receives a telegram with the value "OFF" or "ON", the status LEDs indicate the status of the outputs according to the display length. Manual operation is not activated in this case. The object is only visible if the temporary status indication is activated | | | | | |

10 Dimming operation

10.1 Channel configuration



CAUTION!

Danger of destruction. 400 V are shorted when outputs switched in parallel are connected to different outer phase conductors.

The device will be destroyed.

Always connect outputs switched in parallel to the same outer phase conductor.

Before reducing the number of dimming channels, make sure the load is correctly installed.

Channel configuration

The device is used for dimming up to 4 lighting groups. To increase the channel dimming output power, outputs can be wired in parallel by reducing the number of channels. The assignment of parallel to wired dimming outputs to the KNX-controllable dimming channels takes place in the ETS.

| Number of channels | Output 1 | Output 2 | Output 3 | Output 4 |
|--------------------|-----------|-----------|-----------|-----------|
| 4 | Channel 1 | Channel 2 | Channel 3 | Channel 4 |
| 3 | Channel 1 | | Channel 3 | Channel 4 |
| 3 | Channel 1 | Channel 2 | Channel 3 | |
| 2 | Channel 1 | | Channel 3 | |
| 2 | Channel 1 | Channel 2 | | |
| 2 | Channel 1 | | | Channel 4 |
| 1 | Channel 1 | | | |

Table 1: Options of the channel assignment depending on the number of channels

- i** Parallel wired outputs can only be utilized up to a max of 95 % each.
 -> 2 outputs in parallel: Maximum connected load 427 W!
 -> 3 outputs in parallel: Maximum connected load 640 W!
 -> 4 outputs in parallel: Maximum connected load 855 W!
- i** Connect the 600 W LED lamps or compact fluorescent lamps at most for each 16 A circuit breaker. When connecting transformers, observe the data of the transformer manufacturer.
- i** Observe delivery state. Before connecting and switching on, program the dimming actuator to the changed output configuration.
- i** In the case of parallel wiring of dimming outputs, it is not permitted to connect additional power extensions to the load outputs concerned!

To simplify the configuration, all existing dimming channels can be assigned to the same parameters in the ETS and thus configured identically. The parameter "Channel parameters" on the parameter page "General" specifies whether every dimming channel of the device can be configured individually or whether all channels should be configured by the same parameters.

In the "All channels equal" setting, the number of parameters in the ETS is reduced. The visible parameters are then used on all channels automatically. Only the communication objects can then be configured separately for the channels. This setting should be selected, for example, if all channels behave identically and should only be activated by different group addresses (e. g. in office blocks or in hotel rooms).

- i** The parameter and object configurations of the individual outputs depend on the parameters on the "General" page and are readjusted by the ETS when the channel definition is changed. Consequently, parameter settings or group address assignments to objects can be lost. For this reason, the channel definition should be reset when beginning the parameterization of the actuator!

10.1.1 Channel configuration parameters

General -> Channel configuration

| | |
|----------------------------|--|
| Number of dimming channels | 4 dimming channels (O1) + (O2) + (O3) + (O4) |
| | 3 dimming channels (O1 O2) + (O3) + (O4) |
| | 3 dimming channels (O1) + (O2) + (O3 O4) |
| | 2 dimming channels (O1 O2) + (O3 O4) |
| | 2 dimming channels (O1) + (O2 O3 O4) |
| | 2 dimming channels (O1 O2 O3) + (O4) |
| | 1 dimming channel (A1 A2 A3 A4) |

At this point it is defined which dimming channels are used individually and which dimming channels are connected in parallel. If dimming channels are connected in parallel, the ETS hides unused parameters and communication objects.

| | |
|--------------------|--|
| Channel parameters | each channel individual all channels equal |
|--------------------|--|

To simplify the configuration, all existing dimming channels can be assigned to the same parameters in the ETS and thus configured identically. This parameter stipulates whether every dimming channel of the device can be configured individually or whether all channels should be configured by the same parameters.

In the "All channels equal" setting, the number of parameters in the ETS is reduced. The visible parameters are then used on all channels automatically. Only the communication objects can then be configured separately for the channels. This setting should be selected, for example, if all channels behave identically and should only be activated by different group addresses (e. g. in office blocks or in hotel rooms). In the "Each channel individual" setting, all dimming channels of the device can be configured autonomously.

10.1.2 Object list for channel configuration

| Object no. | Function | Name | Type | DPT | Flag |
|--|--------------------|---------------------------------------|--------|-------|---------------|
| 31, 51, 71, 91 | Switching | Dimming channel ... (...) - Input | 1-bit | 1,001 | C, -, W, -, U |
| 1-bit object for switching the dimming channel on or off ("1" = switch on; "0" = switch off). | | | | | |
| Object no. | Function | Name | Type | DPT | Flag |
| 32, 52, 72, 92 | Switching feedback | Dimming channel ... (...) - Output | 1-bit | 1,001 | C, R, -, T, A |
| 1-bit object for feedback signalling of the switching state ("1" = on / "0" = off) to the bus. | | | | | |
| Object no. | Function | Name | Type | DPT | Flag |
| 34, 54, 74, 94 | Dimming | Dimming channel ... (...) - Input | 4-bit | 3,007 | C, -, W, -, U |
| 4-bit object for relative dimming of a dimming channel. | | | | | |
| Object no. | Function | Name | Type | DPT | Flag |
| 35, 55, 75, 95 | Brightness value | Dimming channel ... (...) - Input | 1-byte | 5,001 | C, -, W, -, U |
| 1-byte object for predefining an absolute dimming value (brightness value 0...255) from the bus. | | | | | |

10.2 Name of the dimming channel

Optional names can be assigned for each dimming output. The names should clarify the use of the output (e. g. "Living room wall lamp", "Bathroom ceiling lamp"). The names are only used in the ETS in the text of the parameter pages and communication objects.

10.2.1 Name of the dimming channel parameters

Dimming channel ... -> DO... - General

| Name of the dimming channel | Free text |
|--|-----------|
| <p>The text entered in this parameter is applied to the name of the communication objects and is used to label the dimming output in the ETS parameter window (e. g. "Living room wall lamp", "Bathroom ceiling lamp").</p> <p>The text is not programmed in the device.</p> | |

10.3 Defining load type



CAUTION!

Risk of destruction if the preset dimming principle and connected load do not match. The dimmer and load may be destroyed.
Before changing the dimming principle, observe load type.
Before changing the load type, make sure that the dimming principle is correct.
Before changing the load type, disconnect the load circuit concerned. Check parameter settings and adjust if necessary.



CAUTION!

Danger of destruction from mixed loads. The dimmer and load may be destroyed.
Do not connect capacitive loads, e. g. electronic transformers, and inductive loads, e. g. inductive transformers, together on the same dimmer output.
Do not connect inductive transformers together with HV LED lamps or compact fluorescent lamps on the same dimmer output.

The device works according to the leading edge phase control or trailing edge phase control dimming principle and makes switching and dimming of incandescent lamps, HV halogen lamps and LV halogen lamps, compact fluorescent lamps as well as HV LEDs and LV LEDs possible by means of conventional transformers and Tronic transformers. The characteristic of the connected load can automatically be measured separately for each dimming channel and the appropriate dimming procedure can be set. Alternatively, the dimming procedure can be predefined by a parameter in the ETS without calibration taking place. This procedure is necessary for loads that do not enable automatic calibration.

- i** When selecting the appropriate dimming principle, the specifications of the lamp manufacturer and/or transformer manufacturer should generally be observed.

- Set the parameter to "Universal (with calibration procedure)".

The dimming channel calibrates itself universally to the connected load type. After programming in the ETS, after bus voltage return, or after switching on the mains voltage supply of a load output, the actuator calibrates itself automatically to the connected load. The calibration procedure becomes noticeable during ohmic loads by a brief flicker and lasts up to 10 seconds depending on the network conditions.

- i** This setting must not be selected for loads that do not enable automatic calibration. In this case, a suitable dimming principle must be preselected (see following settings).

- Set the parameter to "Electronic transformer (capacitive / trailing edge phase control)".

The dimming channel is preset to trailing edge phase control principle. There is no automatic calibration of the load type. Ohmic loads, electronic transformers or LV-LEDs (via Tronic transformers) can be connected to the output.

- Set the parameter to "Conventional transformer (inductive/leading edge phase control)".

The dimming channel is preset to leading edge phase control principle. There is no automatic calibration of the load type. Conventional transformers or LV-LEDs (via conv. transformers) can be connected to the output.

- Set the parameter to "LED (trailing edge phase control)". The dimming channel is preset to an optimized trailing edge phase control principle.

There is no automatic calibration of the load type. HV LED or compact fluorescent lamps optimised for this dimming principle can be connected to the output.

- Set the parameter to "LED (leading edge phase control)".

The dimming channel is preset to an optimised leading edge phase control principle. There is no automatic calibration of the load type. HV LED or compact fluorescent lamps optimised for this dimming principle can be connected to the output. Conventional transformers cannot be connected to the output.

i In the as-delivered state of the device, the dimming principle is set to "Universal" for all outputs.

i When changing a load type on an output, the dimming principle must also be changed if necessary!

Recommendation for the configuration of the dimming principle with HV-LED lamps:

It is recommended to set the "Type of connected load" in the ETS to "Universal" (this dimming principle also corresponds to the as-delivered state of the dimming actuator). If automatic calibration of the load does not work or produces insufficient dimming results, it is recommended to operate HV LED lamps preferably in the load type "LED trailing edge phase control", regardless of the manufacturer's specification. The advantage of this setting lies in the fact that a dimming output can provide the maximum LED nominal load (see technical data). This is often not possible in leading edge phase control principle. Only configure the type of load in the ETS to "LED leading edge phase control" if the operation of the connected LED lamps in the trailing edge phase control principle is not satisfactory (e. g. dimming range is too small).

Protection functions (over-voltage switch-off) ensure that the device is not destroyed if the connected LED lamps are controlled in a dimming principle that the manufacturer has not designed them for.

Problem resolution with HV-LED lamps:

Possible problems during operation of HV LED lamps and their remedial measures are demonstrated in the following.

Parameter setting "LED trailing edge phase control" ->

Problems:

- Dimming range too small
- Minimum brightness too high
- Lamps flicker
- Output switches off due to overvoltage

Remedy: Check operation in the leading edge phase control, reduce connected load as well if necessary, exchange lamps for another type.

Parameter setting "LED leading edge phase control" ->

Problems:

- Lamps flicker
- Dimming actuator overheats (output switches off due to overtemperature)
- Dimming actuator hums

Remedy: Reduce connected load, check operation in the trailing edge phase control, exchange lamps for another type.

10.3.1 Load type parameter

Dimming channel ... -> DO... - General

| | |
|--|---|
| Load type | Universal (with automatic calibration procedure) electronic transformer (capacitive / trailing edge phase control) conv. transformer (inductive / leading edge phase control) LED (trailing edge phase control) LED (leading edge phase control) |
| <p>The dimming principle of the dimming channel is specified here.</p> <p>universal (with automatic calibration procedure): The dimming channel calibrates itself universally to the connected load type. After programming with the ETS, after bus voltage return or after switching on the mains voltage supply of a load output, the actuator calibrates itself automatically to the connected load. The calibration procedure becomes noticeable during ohmic loads by a brief flicker and lasts up to 10 seconds depending on the network conditions.</p> <p>Electronic transformer (capacitive / trailing edge phase control): The dimming channel is preset to the trailing edge phase control principle. There is no automatic calibration of the load type. Ohmic loads or electronic transformers can be connected to the output.</p> <p>Conventional transformer (inductive/leading edge phase control): The dimming channel is preset to the leading edge phase control principle. There is no automatic calibration of the load type. Conventional transformers can be connected to the output.</p> <p>LED (trailing edge phase control): The dimming channel is preset to an optimized trailing edge phase control principle. There is no automatic calibration of the load type. HV LED or compact fluorescent lamps optimised for this dimming principle can be connected to the output.</p> <p>LED (leading edge phase control): The dimming channel is preset to an optimized leading edge phase control principle. There is no automatic calibration of the load type. HV LED or compact fluorescent lamps optimised for this dimming principle can be connected to the output.</p> | |

10.4 Operation with power booster

To increase the connected load, power boosters can be connected to the device.

- i** Power extension possible by means of power boosters (on request).
- i** Choose power boosters that are suitable for the dimmer and load! For additional information, please always refer to the instructions for the power extensions in question.
- i** Visible brightness differences between the lighting on a dimmer actuator output without power booster and a dimming actuator with power booster are possible.
- i** When using conventional power boosters for leading edge phase control or trailing edge phase control principle (NV or TRONIC power boosters) it is not normally necessary to adapt the output signal of the dimming actuator.
- i** In the case of parallel wiring of dimming outputs, it is not permitted to connect additional power extensions to the load outputs concerned!

10.5 Dimming characteristic

The human eye is adapted to natural daylight. As a result, it works in a very wide brightness range from twilight in the early morning and late evening to bright daylight at noon. In the lower brightness area the eye is clearly more sensitive than in the upper area.

When dimming simple lamps, the electrical power is uniformly converted into a luminous flux that is emitted into the surrounding room. This luminous flux results in illuminance that can be measured with a luxmeter. If the lamp emits 50% of its maximum luminous flux, it already appears as intense brightness to the eye. When the luminous flux of the lamp rises to 75%, illuminance increases by the same amount. However, the eye perceives this change much weaker.

When different current lamp types are dimmed, luminous flux and subjective perceptions of brightness can vary considerably. For this reason, the dimming actuator offers several options for adjusting the dimming characteristics as required.

- If the lighting is regularly controlled via percentage presetting of the dimming value, the suitability of the dimming characteristic in the value range should be checked as a priority.
- If the lighting is dimmed manually via the 4-bit object, the dimming characteristic can be adjusted in the time range.

Dimming characteristic curve in the value range

Six characteristic curves are available for adapting to different luminaires, which the dimming actuator can use to convert the percentage input value from the KNX (DPT 5.001) to the output value of the dimming channel. The following table shows the differences in the characteristic curves.

| KNX value | KNX value [%] | Logarithmic function [%] (1) | Root function [%] (2) | Linear function [%] (3) | Square function [%] (4) | Cubic function [%] (5) | Exponential function [%] (6) |
|-----------|---------------|------------------------------|-----------------------|-------------------------|-------------------------|------------------------|------------------------------|
| 0 | 0 | 0 | 0 | 0 | 0 | 0 | 0 |
| 1 | 0.4 | 0 | 6 | 0.4 | 0 | 0 | 0 |
| 10 | 4 | 42 | 20 | 4 | 0 | 0 | 0 |
| 25 | 10 | 58 | 31 | 10 | 1 | 0 | 0 |
| 50 | 20 | 71 | 44 | 20 | 3 | 1 | 0 |
| 80 | 32 | 79 | 56 | 32 | 10 | 3 | 0 |
| 100 | 40 | 83 | 63 | 40 | 15 | 6 | 0 |
| 125 | 50 | 87 | 70 | 50 | 24 | 12 | 0 |
| 150 | 60 | 90 | 77 | 60 | 35 | 20 | 1 |
| 175 | 70 | 93 | 83 | 70 | 47 | 32 | 2.4 |
| 200 | 80 | 96 | 88 | 80 | 62 | 48 | 8 |
| 225 | 90 | 98 | 94 | 90 | 78 | 69 | 25 |

| KNX value | KNX value [%] | Logarithmic function [%] (1) | Root function [%] (2) | Linear function [%] (3) | Square function [%] (4) | Cubic function [%] (5) | Exponential function [%] (6) |
|-----------|---------------|------------------------------|-----------------------|-------------------------|-------------------------|------------------------|------------------------------|
| 255 | 100 | 100 | 100 | 100 | 100 | 100 | 100 |

Table 2: Dimming characteristics in the value range

The connected luminaires convert the dimmed output voltage into a luminous flux that is emitted into the room. This luminous flux is different for each type of lamp. The subjective brightness perception of the human eye differs from the illuminance that can be measured.

The following diagrams present a comparison for a lamp type of the measured illuminance and the brightness perceived for the dimming characteristics that can be set in the ETS. Because the properties of different lamp types deviate from one another, the most suitable dimming characteristic must be determined locally if necessary. If an existing lamp is replaced by a lamp of a different type, it may be useful to change the dimming characteristic.

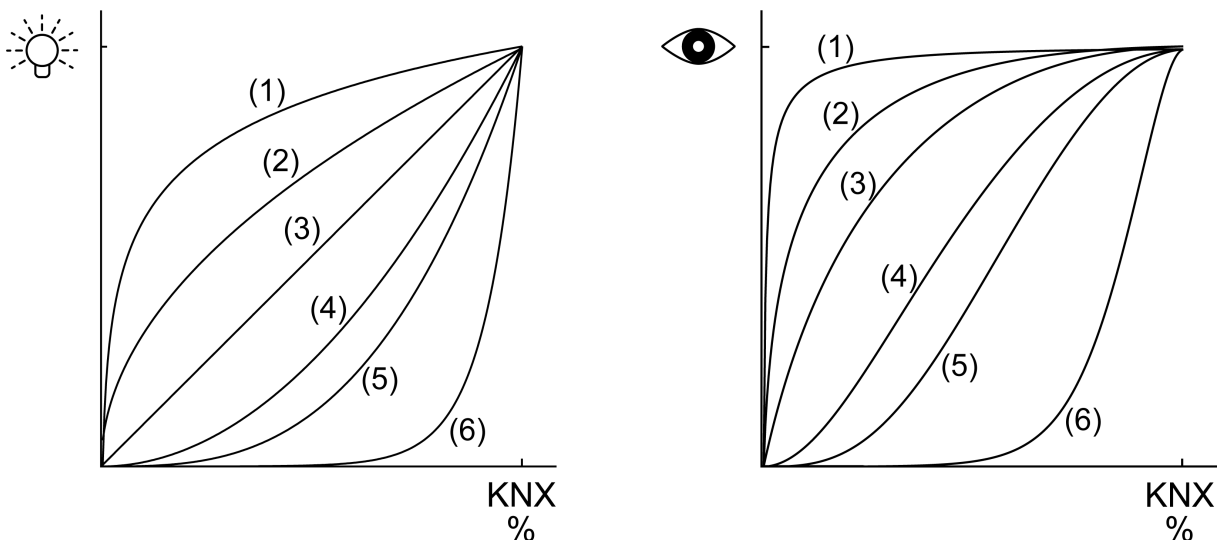

Figure 6: Dimming characteristics in the value range

Setting the dimming characteristic in the value range

In the as-delivered state, the linear dimming characteristic is set in the value range. If the dimming behaviour is not satisfactory, particularly in the lower dimming range, the dimming behaviour may be improved by selecting a different dimming characteristic. The adjustment of the dimming characteristic is related to the adjustment of the lower brightness limit and the maximum brightness.

The 1-byte brightness value communication object is connected to a group address. The maximum brightness is set to 100%. When a brightness value is received, the value is jumped to.

- Check/set the lower brightness limit.
- Gradually increase the brightness value and evaluate the brightness change.
- If the brightness change in the lower range is too strong, select a flatter characteristic curve.

- If the brightness change in the lower range is too weak, select a steeper characteristic curve.
- For maximum brightness, select the brightness value from which no change is visible in the upper range.

The dimming characteristic is set in the value range.

i If dimming operation cannot be set properly with the dimming characteristics in the value range, check the load type or replace the lamp with another type.

Dimming characteristic curve in the time range

In the case of the dimming actuator, the technically dimmable brightness range (basic brightness ... 100 %) is subdivided into 255 dimming increments (8-bit brightness value: 1...255 / 0 = switched off). In the as-delivered state of the actuator, the dimming increment times, i. e. the dimming times between 2 of 255 dimming increments, are set to the identical length. This results in a linear characteristic curve over the entire brightness range.

The dimmable brightness range is limited at the upper limit by the maximum brightness configured in the ETS. The lower brightness range is either defined by the basic brightness ("level 1", "level 2" to "level 8" -> "1%") or alternatively, by the minimum brightness. The dimming characteristics shown in the following diagrams distinguish these configurations and illustrate the resulting real dimming time of a dimming procedure.

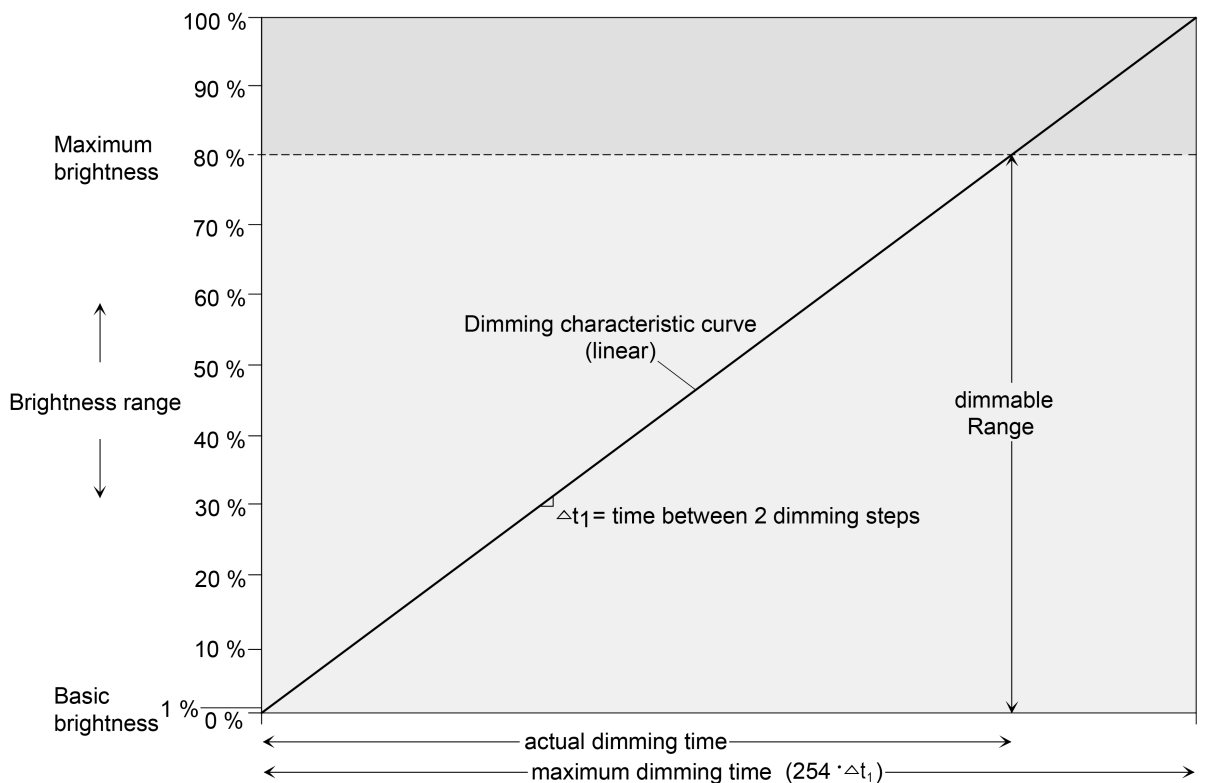

Figure 7: Linear dimming characteristic as an example with basic brightness and maximum brightness

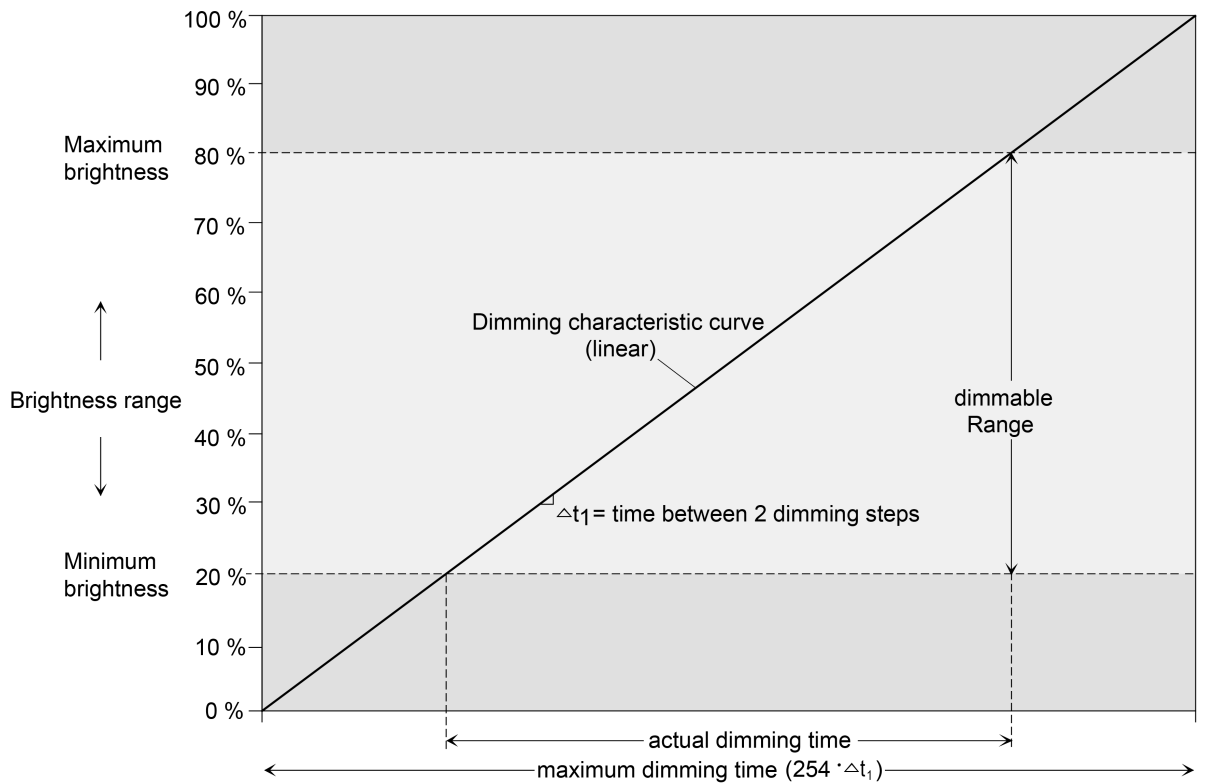

Figure 8: Linear characteristic dimming curve as an example with minimum brightness > 0 % and maximum brightness

In some practical applications, a linear dimming characteristic is not optimal. Hence, the actuator in the ETS alternatively permits a user-defined adjustment of the dimming progress. In this way, for example, brightness changes can be adjusted to the brightness sensitivity of the human eye when dimming by subdividing the brightness range in up to 5 sections with different dimming increment times.

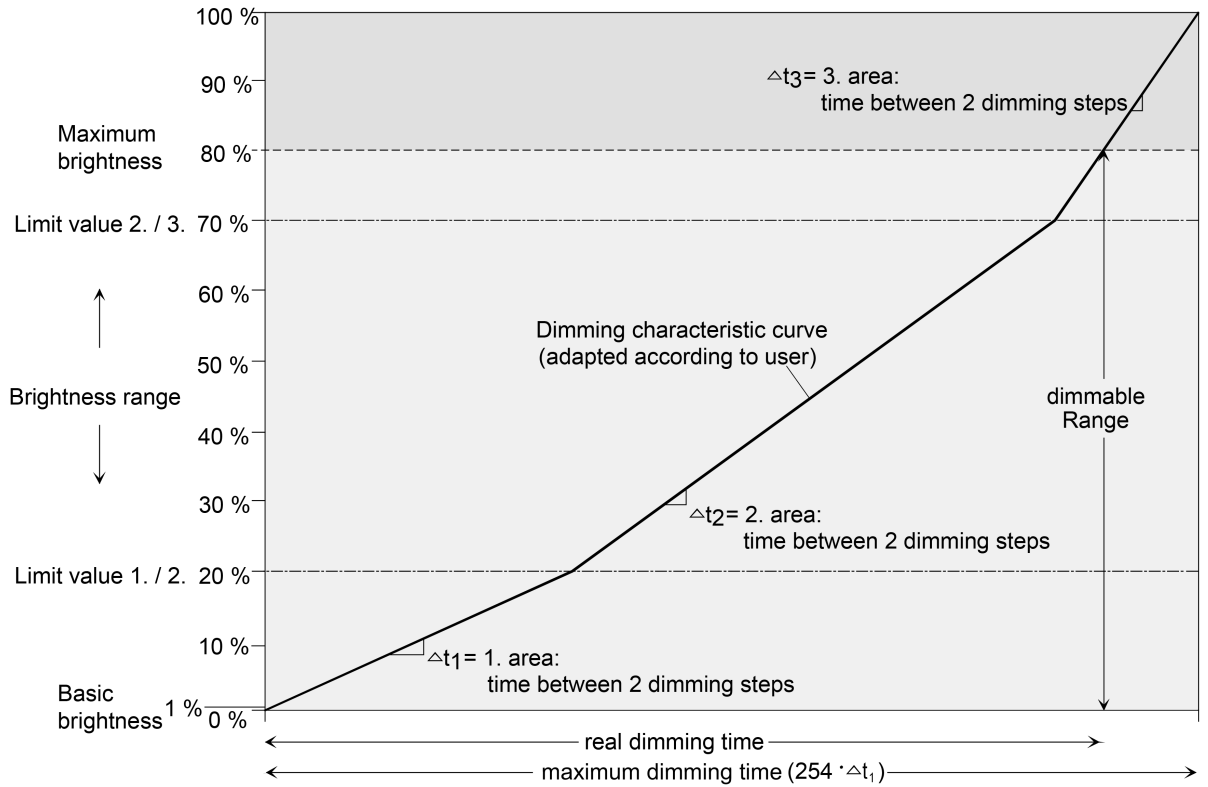

Figure 9: User-defined dimming characteristic as an example with basic brightness and maximum brightness

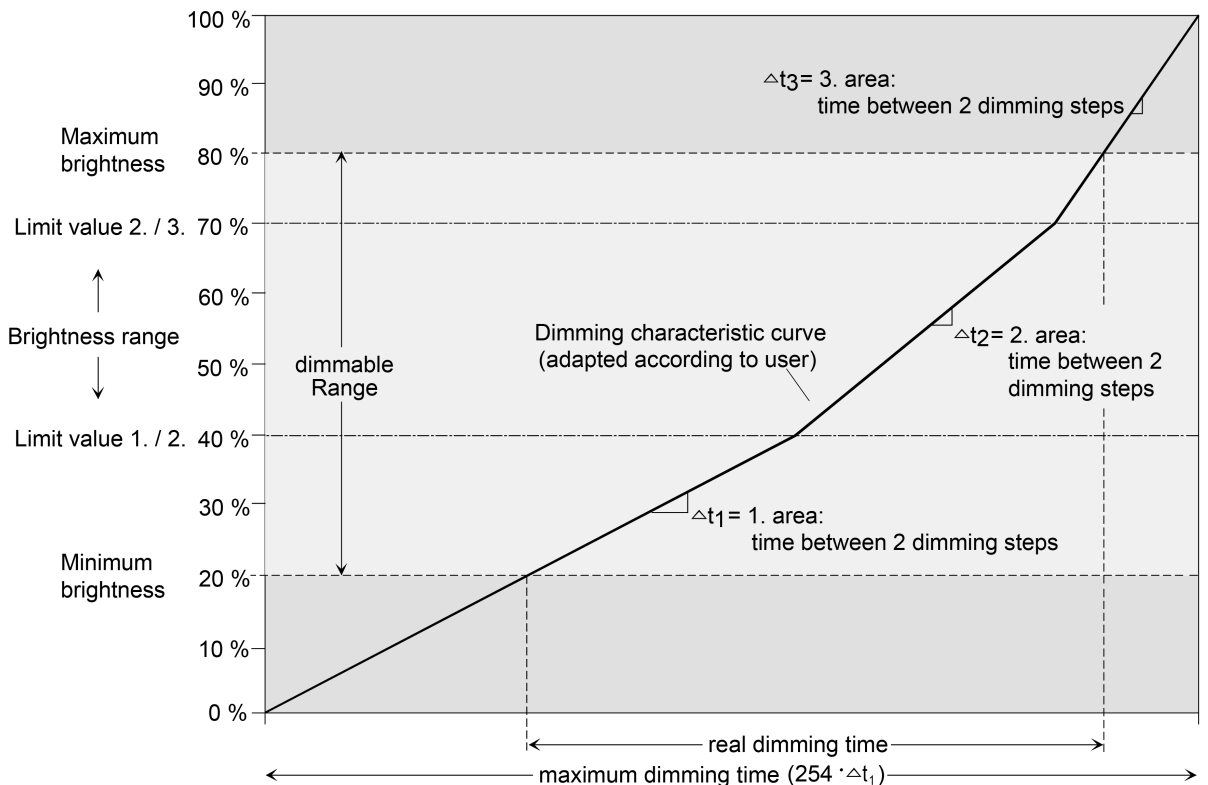

Figure 10: User-defined dimming characteristic as an example with minimum brightness and

Setting the dimming characteristic in the time range

- Set the parameter "Characteristic curve in the time range" on the parameter page "DAX - Dimming characteristic" (x = number of the dimming channel 1...4) to "Linear function".

A linear dimming characteristic curve is set. A time between two dimming increments can also be configured for the entire brightness range in the ETS.

- Set the parameter "Characteristic curve in the time range" on the parameter page "DAX - Dimming characteristic" (x = number of the dimming channel 1...4) to "User-defined (y ranges)" (y = 2...5).

A user-defined dimmer characteristic curve is set. Up to 4 limiting values and 5 times between two dimming increments can be defined for the definition of the brightness sections

The dimming increment speed is identical for a relative dimming procedure or for the dimming of an absolute brightness value (not fading) and can be set in the ETS separately for each dimming channel in the characteristic parameters.

The parameter "Characteristic curve" in the time range is set to "Linear".

- Set the parameter "Time between two dimming increments" on the parameter page "DAX - Dimming characteristic" (x = number of the dimming channel 1...4) to the necessary dimming increment time.

During every relative or absolute dimming procedure, the entire brightness range is dimmed with the configured dimming increment speed.

The parameter "Characteristic curve" is set to "User-defined".

- First define the brightness limit values. For this purpose, set the parameter "Until brightness limiting value" of the various ranges on the parameter page "DAX - Dimming characteristic" (x = number of the dimming channel 1...4) to the necessary section limits.

When configuring the limiting values, care must be taken to ensure that the values do not exceed the maximum brightness or fall below the configured minimum brightness.

The dimmable brightness range is divided into up to 5 sections. In the following, the dimming increment speeds for these three areas can be set separately.

- Set the parameter "Time between two dimming increments" on the parameter page "DAX - Dimming characteristic" (x = number of the dimming channel 1...4) to the necessary dimming increment time for each section.

The dimming characteristic is defined ready. Each of the up to 5 sections is dimmed at the specified dimming increment speed.

10.5.1 Parameter Dimming characteristic

Dimming channel ... -> DO... - General -> Dimming characteristic

| | |
|--|--|
| Characteristic curve in the time range | Linear function User-defined (2 ranges) User-defined (3 ranges) User-defined (4 ranges) User-defined (5 ranges) |
|--|--|

The dimming characteristic curve of the dimming channel in time domain can be set here. The lamp used can thus be adapted to the brightness sensitivity of the human eye.

Linear function: The brightness curve of basic brightness (decimal brightness value "1") up to 100% (decimal brightness value "255") is linear.

User-defined (... Ranges): The brightness curve between basic brightness / minimum brightness and maximum brightness can be adapted individually. For this purpose, the brightness range is subdivided in up to 5 sections. Each section can be configured with an independent dimming speed.

| | |
|-------------------------------------|---------------------|
| Range ... | 1 ... 25 ... 255 ms |
| Time between two dimming increments | |

At this point, the dimming step speed (time between two dimming values) of the respective partial range is set.

With a linear characteristic curve there is only range 1.

| | |
|---------------------------------|------------------|
| Range ... | Basic brightness |
| until brightness limiting value | 5 % |
| | 10 % |
| | ... |
| | 100 % |

The brightness limiting value is configured here. This limiting value defines the boundary between the first and second section.

With a linear characteristic curve, the limit value is fixed at 100 %.

| | |
|--|--|
| Characteristic curve in the value range | Linear function Exponential function Cubic function Square function Root function Logarithmic function |
| <p>Setting the characteristic curve in the value range allows the 256 dimming steps possible on KNX to be adapted to the perception of the human eye. If this parameter is changed, the curve of the characteristic curve is shown in the diagram below.</p> <p>The selection of the characteristic curve depends on the connected lamp.</p> | |

10.6 Brightness range

The brightness range, adjustable by switching or dimming procedures, can be limited by defining a lower and upper brightness value. The lower brightness value is either defined by the basic brightness, or alternatively, by the minimum brightness. The upper brightness value is always characterised by the maximum brightness. The maximum brightness adjustable in the ETS is never exceeded under any circumstances in the switched-on operating state of a dimming channel. Neither when switching on nor when dimming. The maximum brightness value can be reduced for energy saving reasons, for example. In combination with some power boosters, it may also be necessary to reduce the maximum brightness (please observe the documentation of the power boosters and notes in the chapter "Mounting and electrical connection" in this documentation!). Furthermore, the brightness value, which should be set whenever switching on via the "Switching" or "Central switching" object or by manual operation on the dimming channel, can be predefined. This switch-on brightness must always be between the upper and lower brightness limit value of the dimming range. The adjustable characteristics of the lower brightness value in the ETS differ as follows...

- Definition of the lower brightness limit with basic brightness (see figure 11):

The "Basic brightness" parameter on the parameter page "DAX – General" (x = number of the dimming channel 1...4) sets the lower brightness threshold by adapting to the luminaire.

The basic brightness can be set to one of 8 step values and is a gauge for the minimum adjustable residual phase angle of the output signal in relation to the decimal brightness values "1", "2" and "3" (percentage: ~0.4 ... 1 %). The basic brightness can be undershot only by switching off. The configurable basic brightness enables the dimming signal to be adjusted in the smallest possible dimming position of the luminaire used. The basic brightness should be set to a step value at which the lamp at the smallest brightness value will still light up at an adequate level of brightness so that it is detected as switched on. A recommendation for incandescent lamps and halogen lamps is given in the ETS as an adjustment aid.

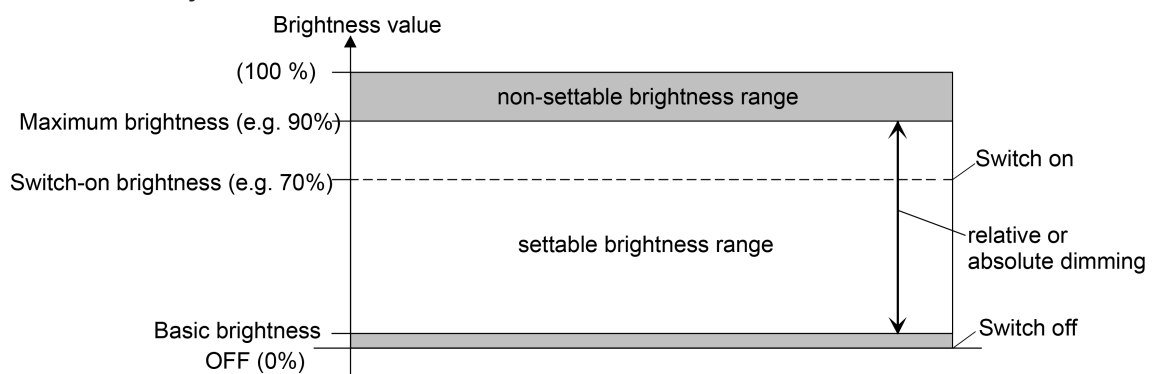

Figure 11: Example of a brightness range with basic brightness

- Definition of the lower brightness limit with minimum brightness (see figure 12):

The "Minimum brightness" parameter on the parameter page "DAX – General" (x = number of the dimming channel 1...4) sets a lower brightness threshold in the percentage range 1% ... 100 % (decimal "3" ... "255") in stages. The minimum brightness cannot be undershot in any switched-on operating state of the dimming channel. An undershot is only possible by switching off.

The brightness of the controlled lamps can be adapted individually – even to the brightness sensitivity of the human eye - by using the minimum brightness.

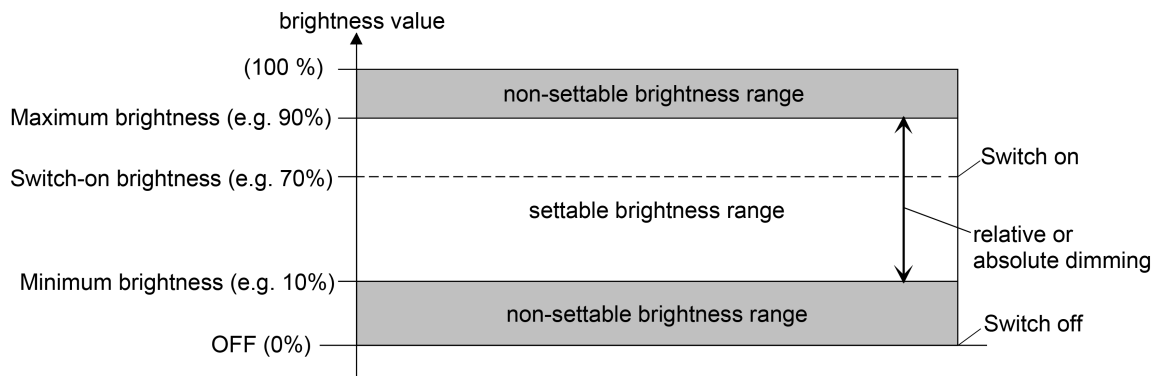

Figure 12: Example of a brightness range with minimum brightness

Adjusting basic brightness

The basic brightness can be set separately for each dimming channel.

The parameter "Lower brightness limit" is set to "As basic brightness".

- Set the "Basic brightness" parameter to the required level value.

The set level value is a gauge for the smallest adjustable residual phase angle of the output signal and therefore cannot be undershot in any switched-on operating state of the dimming channel.

- i** The parameter should be set in such a way that the lamp will still light up at the lowest dimmer setting.
- i** When operating a universal power booster on the dimmer output (see parameter "Operation with universal power booster (OLD)"), "Level 1" can be set, but has no effect. If the parameter should be set to level 1 in this case, the device executes level 2 as basic brightness.

Setting the minimum brightness

The minimum brightness can be set separately for each dimming channel.

The parameter "Lower brightness limit" is set to "As minimum brightness".

- Set the "Minimum brightness" parameter to the required brightness value.

The set brightness is not undershot in any switched-on operating state.

- i** The ETS does not check all configured brightness values of a channel during the editing of the minimum brightness (e. g. switch-on brightness, scene values)! If values that are smaller than the configured minimum brightness are predefined by the ETS configuration, the actuator sets the minimum brightness

as brightness value later during operation. The same holds true if the actuator receives values via the brightness object during operation, which undershoots the minimum brightness.

Setting the maximum brightness

The maximum brightness can be set separately for each dimming channel.

- Set the "Maximum brightness" parameter on the parameter page "DAx - General" (x = number of dimming channel 1...4) to the required brightness value.

The set brightness is not undershot in any switched-on operating state of the dimming channel.

- i** The ETS does not check all configured brightness values of a channel during the editing of the maximum brightness (e. g. switch-on brightness, scene values)! If values that are greater than the configured maximum brightness are predefined by the ETS configuration, the actuator sets the maximum brightness as brightness value later during operation. The same holds true if the actuator receives values via the brightness object during operation, which exceed the maximum brightness.
- i** When extending the power of an output of a dimming channel from our company by means of universal power boosters, the maximum brightness (ETS parameter) must be reduced to 90 % at most!

10.6.1 Brightness range parameter

Dimming channel ... -> DO... - General -> Brightness range

| | |
|---|--|
| Lower brightness limit | as basic brightness as minimum brightness |
| <p>The brightness range, adjustable by switching or dimming procedures, can be limited by defining a lower and upper brightness value.</p> <p>The lower brightness value is either defined by the basic brightness, or alternatively, by the minimum brightness. The upper brightness value is always characterised by the maximum brightness. The maximum brightness adjustable in the ETS is never exceeded under any circumstances in the switched-on operating state of a dimming channel. Neither when switching on nor when dimming.</p> <p>This parameter defines whether the adjustable brightness range at the lower limit will be limited by the basic brightness or by a minimum brightness.</p> | |
| Basic brightness | Level 1 Level 2 Level 3 ... Level 8 |
| <p>The step value set here is a gauge for the minimum adjustable residual phase angle of the output signal and is set to the decimal brightness values "1", "2" and "3".</p> <p>The step value cannot be undershot in any switched-on operating state of the dimming channel.</p> <p>This parameter is only visible if the "Lower brightness limit" is set to "Basic brightness".</p> | |
| Minimum brightness | 1 % 5 % 10 % ... 100 % |
| <p>The brightness set here is not undershot in any switched-on operating state.</p> <p>This parameter is only visible if the "Lower brightness limit" is set to "Minimum brightness".</p> | |
| Maximum brightness | 1 % 5 % 10 % ... 100 % |
| <p>The brightness set here is not exceeded in any switched-on operating state.</p> | |

10.7 Switching/dimming behaviour

Switch-on brightness

The switch-on brightness can be set separately for each dimming channel.

- Set the "Switch-on brightness" parameter on the parameter page "DAx - General" (x = number of dimming channel 1...4) to the required brightness value.

The set brightness is set after receipt of an ON telegram via the "Switching" communication object or by switching on by the manual operation on the dimming channel. Furthermore, the configured switch-on brightness is set with the "activated" polarity after receipt of a central telegram.

- Alternatively, set the parameter "Switch-on brightness" to "Memory value (brightness before switching off last time)".

When switching on, the active and internally saved brightness value prior to switching off last time is set (via the "Switching" or "Central switching" object). After programming with the ETS, the value is predefined to maximum brightness. A bus voltage failure, however, does not delete the memory value.

i If the configured switch-on brightness is greater than the configured maximum brightness, the actuator sets the maximum brightness as the new brightness value for the dimming channel concerned when switching on (minimum brightness < switch-on brightness < maximum brightness).

i A memory value is also then saved internally by a switch-off telegram if the bus-controlled switch-off is overridden, for example, by a disable or forced position function or by a manual operation. In this case, the internally tracked brightness value is saved as memory value.

i If no soft ON function is activated, the brightness value is jumped to when switching on. Once a soft ON function is activated, the switch-on brightness is dimmed according to the dimming speed for the soft ON function.

Behaviour when receiving a brightness value

The dimming behaviour for the absolute dimming can be set separately in the ETS for each dimming channel via the "Brightness value" object.

- Set the parameter "On receipt of a brightness value" on the parameter page "DAx - General" (x = number of dimming channel 1...4) to "Dim".

Once a new brightness value is received, it is set by means of the configured dimming increment time based on the predefined dimming characteristic.

- Set the parameter "Dimming behaviour after receipt of a brightness value" to "Jump to".

As soon as a new brightness value is received it will be instantly jumped to.

- Set the parameter "Dimming behaviour after receipt of a brightness value" to "Fading". In addition, on the parameter "Time for brightness value via fading", define the necessary fading time for dimming the scene brightness value.

Newly received brightness values will be dimmed. The dim fading is activated. The fading time defines the duration of the dimming procedure required to reach the new brightness value. The brightness value of a dimming channel on which the dimming starts and the configured dimming characteristic have no significance. The dimming procedure thus always requires the exact pre-defined time when specifying a new brightness value.

- i** Brightness values can also be set by a disabling or forced position function. Absolute dimming can also be activated, even in case of bus voltage failure, after bus voltage return or after programming with the ETS, by specifying brightness values. In the case of these absolute dimming functions, the brightness values are always instantly jumped to. During a scene recall, the dimming behaviour can be configured separately.

Dimming up in the switched-off state

A relative dimming process can be triggered by the 4-bit "Dimming" communication object available separately in each dimming channel or by a long button-press of the manual operation. The data format of the "Dimming" object complies with the KNX standard DPT "3.007", which means that the dimming direction and relative dimming increments can be predefined in the dimming telegram or dimming procedures can also be stopped. A relative dimming process is executed via the object until the configured basic/minimum or maximum brightness of the dimming channel is set, the dimming value reaches the dimming increment predefined in the telegram or a stop telegram is received. A relative dimming process allows a brightness value to be changed constantly and always starts from the brightness that is set stationary or dynamically at the time of the incoming dimming telegram.

A relative dimming telegram can also switch on a dimming channel if this is in the "OFF" state. In some applications, it may be necessary, however, for a switched off dimming channel to remain off until a relative dimming telegram is received. This is interesting when using light scenes, for instance: Several dimming channels are set to a defined brightness value via a light scene. Other channels are switched off by the scene. Only the brightness of channels not switched off by the scene recall should be changed by dimming up afterwards. Here, it is necessary for dimming channels not to react to a relative dimming operation and thus not to switch on.

The parameter "With relative dimming up in the switched-off state" defines whether or not a dimming channel in the "OFF" state reacts to a relative dimming telegram.

- Set the parameter to "Switch on channel".

The dimming channel always reacts to a relative dimming telegram and executes a dimming process. In the "OFF" state, the channel switches on with a "Dim up" telegram.

- Set the parameter to "No reaction".

The dimming channel only reacts to a relative dimming telegram when it is switched on. In the "OFF" state, the channel ignores a "Dim up" telegram.

- i** In manual operation on the device, it is possible in the "OFF" state to always switch on and increase brightness by a long press of the button. The parameter "With relative dimming up in the switched-off state" thus has no effect on manual operation.

10.7.1 Switching/dimming behaviour parameters

Dimming channel ... -> DO... - General -> Switching/dimming behaviour

| | |
|--|---|
| Switch-on brightness | Basic brightness 5% 10% ... 100% Memory value (brightness before last switch-off) |
| <p>This parameter specifies the brightness value, which should be set whenever switching on via the "Switching" or "Central switching" object or by manual operation on the dimming channel. The switch-on brightness must always be between the upper and lower brightness limit value of the dimming range.</p> <p>The selection of "Basic brightness" is not necessary when using a minimum brightness.</p> <p>In the "Memory value" setting, the active and internally saved brightness value prior to switching off last time is set when switching on (via the "Switching" or "Central switching" object).</p> | |
| On receipt of a brightness value | jumping to dimming to Fading |
| <p>A parameter is used here to define whether a brightness value received via the bus is instantly jumped to (absolute dimming), or whether the brightness is dimmed to via the set dimming characteristic. Fading is also possible as an alternative. When fading, the received brightness value is reached in the exact configured fading time irrespective of the dimming characteristic and irrespective of which brightness value the dimming procedure was started at. Thus, for example, several dimming outputs can be set to the same brightness at the same time.</p> | |
| Time for brightness value via fading | 0 ... 20 ... 240 s |
| <p>The fading time is set here if fading is predefined in the dimming behaviour. A dimming procedure via fading lasts for the exact configured time. If "0" is set, the brightness value is jumped to directly.</p> | |

| | |
|---|---|
| With relative dimming up in the switched-off state | switch ON channel no reaction |
| <p>This parameter defines whether or not a dimming channel in the "OFF" state reacts to a relative dimming telegram.</p> <p>Switch on channel: The dimming channel always reacts to a relative dimming telegram and executes a dimming process. In the "OFF" state, the channel switches on with a "Dim up" telegram.</p> <p>no reaction: The dimming channel only reacts to a relative dimming telegram when it is switched on. In the "OFF" state, the channel ignores a "Dim up" telegram.</p> | |

10.8 Central functions

The actuator offers the possibility of selectively connecting individual or all dimming outputs with up to 6 central functions. Like the dimming channels, each central function has a 1-bit object, a 4-bit object and a 1-byte object. The behaviour during the control of an output via the central functions can be set to "Switching & dimming" or alternatively to "Permanent" (Switching with priority).

Central function = "Switching & dimming":

This function is comparable to various central group addresses that are linked to the "Switching" object, "Dimming" object and "Brightness value" object of a dimming output. The last command received (ON or OFF, dimming or brightness value) is executed. The polarity of the switching telegram can be configured as inverted if necessary.

The parameter "With relative dimming up in the switched-off state" defines whether or not a dimming channel in the "OFF" state reacts to a relative dimming telegram of the central "Dimming" object.

Central function = "Permanent":

The assigned dimming outputs are controlled according to the parameterised command (ON or OFF) and locked during central control. The "Dimming" object and "Brightness value" object of the central function is not evaluated by the dimming outputs assigned. This means that no other central function with the "Switching & dimming" function can control the locked output. Controls via normal switching objects are possible. If an output is assigned to several permanent central functions, the parameterised command decides on the priority of the central function. A "Permanent OFF" has a higher priority than a "Permanent ON" and thus is preferably executed. Activating a central function "Permanent OFF" deactivates other assigned functions for an output with the setting "Permanent ON".

Example of permanent central functions

An output is assigned to central function 1 "Switching", central function 2 "Permanent OFF" and central function 3 "Permanent ON". Central functions 2 and 3 are initially deactivated.

When a central telegram = "Activate" on central function 3 is received, the assigned output switches on. In this state, it can no longer be controlled by central function 1, since a simple "Switching" has a lower priority. When a central telegram = "Activate" on central function 2 is received, the assigned output switches off immediately. Central function 3 is thus deactivated automatically. Only when central functions 2 and 3 are deactivated can the assigned output be controlled again by central function 1.

- i** All central functions are inactive after the bus voltage returns. No central functions are saved in the event of a bus voltage failure.

In the case of control via a central function, the transmission of the feedback signals of the switching status and the brightness value can be delayed for each channel. This setting is only effective if the objects of the respective feedback are set as active signal objects.

Disconnect central functions

- Activate the central functions on the parameter page "General -> Central functions" with the parameter "Central functions".

The central objects become visible in the ETS. Names can optionally be assigned for the central functions. The names should illustrate the use of the individual central functions (e. g. "All ON", "Central OFF"). The names are only used in the ETS in the text of the central functions and central objects.

Assign dimming outputs to the central functions

Each dimming output can be assigned to the central functions.

The central functions must be enabled on the parameter page "General -> Central functions".

- The parameters "Function and polarity of the central object" on the parameter pages "Dimming channel ... -> DO... - General" to the desired function.

The appropriate output is assigned to the central function. It can be influenced centrally.

- i** The state newly set by the central functions is tracked in the feedback objects and also transmitted to the bus, if these are actively transmitting.

10.8.1 General central functions parameter

General -> Central functions

| | |
|--|---------------------|
| Central functions | Checkbox (yes / no) |
| If the parameter is activated, the 6 central functions of the dimming outputs and thus the objects "Central function ... Switching input", "Central function ... Dimming input" and "Central function ... Brightness value input" are enabled. An assignment of individual dimming outputs to the central functions is only possible if the function is enabled. | |

| | |
|---|-----------|
| Name of the central functions | Free text |
| Names can optionally be assigned for the central functions. The names should illustrate the use of the individual central functions (e. g. "All ON", "Central OFF"). The names are only used in the ETS in the text of the central functions and central objects. | |

Dimming channel ... -> DO... - General

| | |
|--|---------------------|
| Delay for feedbacks | Checkbox (yes / no) |
| The states of the switching status feedback and brightness value feedback can be transmitted to the KNX with a delay in the case of control with a central function. | |

| | |
|---|----------------------------------|
| Delay time | 0 ... 59 min 0 ... 5 ... 59 s |
| These parameters define the delay for switching status feedback and brightness value feedback for control with a central function. These parameters are only available if the delay for feedback signals is activated. | |

| | |
|---|---------------------|
| Central function X assignment (X = 1 ... 6) | Checkbox (yes / no) |
| These parameters assign the additional functions to the selected dimming channel. These parameters are only visible when central functions are enabled. | |

| | |
|--|--|
| Function and polarity central objects | Switching (1 = ON / 0 = OFF) & dimming Switching (0 = ON / 1 = OFF) & dimming Permanent ON (switching: 1 = active / 0 = inactive) Permanent OFF (switching: 1 = active / 0 = inactive) |
| <p>The function and polarity of the central function is selected here.</p> <p>Switching (1 = ON/0 = OFF) & dimming: The last command received (ON or OFF) or dimming is executed. The polarity of the central telegram for switching is preset: 1 = ON/0 = OFF</p> <p>Switching (0 = ON/1 = OFF) & dimming: The last command received (ON or OFF) or dimming is executed. The polarity of the central telegram for switching is preset: 0 = ON/1 = OFF</p> <p>Permanent ON (1 = active/0 = inactive): The assigned dimming channel is switched on and locked during central control. The "Dimming" object and "Brightness value" object of the central function is not evaluated by the dimming outputs assigned.</p> <p>Permanent OFF (1 = active/0 = inactive): The assigned dimming channel is switched off and locked during central control. The "Dimming" object and "Brightness value" object of the central function is not evaluated by the dimming outputs assigned.</p> <p>If an output is assigned to several permanent central functions, the parameterised command decides on the priority of the central function. A "Permanent OFF" has a higher priority than a "Permanent ON" and thus is preferably executed. With permanent function, the polarity of the central telegram is always fixed: 1 = activate permanent control / 0 = deactivate permanent control.</p> <p>These parameters are only visible when central functions are enabled and assigned.</p> | |

| | |
|--|---|
| With relative dimming up in the switched-off state | switch ON channel no reaction |
| <p>This parameter defines whether or not a dimming channel in the "OFF" state reacts to a relative dimming telegram.</p> <p>Switch on channel: The dimming channel always reacts to a relative dimming telegram and executes a dimming process. In the "OFF" state, the channel switches on with a "Dim up" telegram.</p> <p>no reaction: The dimming channel only reacts to a relative dimming telegram when it is switched on. In the "OFF" state, the channel ignores a "Dim up" telegram.</p> <p>This parameter is only visible with the switching & dimming settings.</p> | |

10.8.2 Object list for general central functions

| Object no. | Function | Name | Type | DPT | Flag |
|--|------------------|---------------------------------------|--------|-------|-----------------|
| 5, 8, 11, 14, 17, 20 | Switching | Central function ... (...) - Input | 1-bit | 1,001 | C, (R), W, -, A |
| 1-bit object for switching the dimming channel on or off ("1" = switch on; "0" = switch off). | | | | | |
| Object no. | Function | Name | Type | DPT | Flag |
| 6, 9, 12, 15, 18, 21 | Dimming | Central function ... (...) - Input | 4-bit | 3,007 | C, (R), W, -, A |
| 4-bit object for relative dimming of a dimming channel. | | | | | |
| Object no. | Function | Name | Type | DPT | Flag |
| 7, 10, 13, 16, 19, 22 | Brightness value | Central function ... (...) - Input | 1-byte | 5,001 | C, (R), W, -, A |
| 1-byte object for predefining an absolute dimming value (brightness value 0...255) from the bus. | | | | | |

10.9 Times

Delay after bus voltage returns

To reduce telegram traffic on the KNX bus line after bus voltage activation (bus reset), after connection of the device to the bus line or after an ETS programming operation, it is possible to delay all actively transmitted status or feedback telegrams of the switching function. For this purpose, a channel-independent delay can be specified (parameter "Delay after bus voltage returns" on parameter page "General"). Only after the configured time elapses are feedback telegrams for initialisation transmitted to the KNX.

Which of the telegrams is actually delayed can be set for each output and status function separately.

- i** The delay has no effect on the behaviour of the outputs. Only the bus telegrams for status or feedback are delayed. The outputs can be activated also during the delay after the bus voltage returns.
- i** A setting of "0" for the delay after the bus voltage returns fully deactivates the time delay. In this case, any messages, if actively transmitted, will be transmitted to the KNX without any delay.

Time for flashing of the disabling function

A disabling function can be activated separately for each channel as an additional function (see chapter "Disabling function/Forced position" ▶ Page 143). With this disabling function it is possible to have the output flash at the start or end of disabling. The time for flashing is set collectively for all channels.

10.9.1 General times parameter

General -> Times

| | |
|---|-----------------------------------|
| Delay after bus voltage returns | 0 ... 59 min 0 ... 17 ... 59 s |
| To reduce telegram traffic on the bus line after bus voltage activation (bus reset), after connection of the device to the bus line or after programming with the ETS, it is possible to delay all active feedback telegrams of the actuator. The parameter specifies in this case a delay valid for all devices. Only after the time configured here has elapsed are feedback telegrams for initialisation transmitted to the bus. | |
| Time for flashing of the disabling function | 1 s, 2 s, 5 s, 10 s |
| At the start and end of the "Disable" supplementary function, a dimming channel can flash. The flash cycle time is generally set here for all dimming channels concerned. | |

10.10 Reset and initialisation behaviour

Response after a device reset

The switching states or brightness values of the dimming channels after a bus voltage failure, bus voltage return or after an ETS programming operation, can be preset separately.

Presetting the behaviour after ETS programming

The parameter "After ETS programming" is preset separately for each dimming channel on the parameter page "DAx - General" (x = number of the dimming channel 1...4). This parameter can be used to configure the brightness behaviour of a channel, irrespective of the behaviour after the bus voltage returns.

- Set parameter to a brightness value.

The dimming channel is set to the predefined brightness value. It is important that the configured value does not undershoot the set minimum brightness (if present) or exceed the maximum brightness.

- Set the parameter to "Switch off".

The dimming channel is switched off after a programming in the ETS.

- Set the parameter to "No reaction".

After an ETS programming operation, the dimming channel shows no response and remains in the switching brightness state currently selected or is switched off.

- Set the parameter to "As when bus voltage returns".

After an ETS programming operation, the dimming channel evaluates the setting of the parameter "After bus voltage returns" and sets the status defined there.

i The configured behaviour will be executed after every application or parameter download by the ETS. A simple download of the physical address alone or partial programming of only the group addresses has the effect that this parameter is disregarded and that the configured "After bus voltage return" will be executed instead!

i The actuator briefly initialises after each ETS programming operation. Dimming channels whose load type is configured to "Universal" calibrate themselves to the load. The calibration procedure becomes noticeable during ohmic loads by a brief flicker and lasts up to 10 seconds depending on the network conditions.

i A switching state and brightness value set after an ETS programming cycle is added to the feedback objects. Actively transmitting feedback objects also only first transmit after an ETS programming cycle when the initialisation has finished and, if necessary, the "Delay time after bus voltage returns" has elapsed.

- i** In the "No reaction" setting: After the programming operation, a brief switch-off occurs during the initialisation phase of the actuator. Afterwards, the brightness value that was active before is then reset again.
- i** An active manual operation mode will be terminated by an ETS programming operation.
- i** After an ETS programming operation, the disabling functions and the forced-positions are always deactivated. The brightness values and forced position objects saved in case of the bus voltage failure are deleted.

Setting the behaviour in case of bus voltage failure

The parameter "After bus voltage failure" can be preset separately for each dimming channel on the parameter page "DAX - "General" (x = number of dimming channel 1...4). This parameter can be used to configure the brightness behaviour of a channel, irrespective of the behaviour after the bus voltage returns.

- Set parameter to a brightness value.

The dimming channel is set to the predefined brightness value. It is important that the configured value does not undershoot the set minimum brightness (if present) or exceed the maximum brightness.

- Set the parameter to "Switch off".

The dimming channel is switched off in the case of bus voltage failure.

- Set the parameter to "No reaction".

In case of bus voltage failure, the dimming channel shows no reaction and remains in the currently set brightness state or is switched off.

- i** Active disabling or forced position functions are cancelled by a bus voltage failure and remain inactive until they are reactivated.
- i** In case of a bus voltage failure, the current states of the forced-positions are also saved so that they can be tracked when the bus voltage returns if necessary (depending on the parameterization of the forced positions).
- i** In case of a bus voltage failure, the current brightness values of all dimming channels are permanently saved internally so that these brightness values can be reset after the bus voltage returns if this is configured in the ETS. The data is stored before the configured reaction for bus voltage failures takes place and only if the bus voltage has been available before without interruption for at least 20 seconds after the last reset (storage capacitors sufficiently charged for storage purposes). In all other cases nothing is stored (brightness value = "0").
- i** If the bus voltage fails while manual operation is activated on the device, the parameter "Behaviour in case of bus voltage failure" is not executed.

Setting the behaviour after the bus voltage returns

The parameter "Behaviour after bus voltage return" is created separately for each dimming channel on the parameter page "DAX - General" (x = number of dimming channel 1...4).

- Set parameter to a brightness value.

The dimming channel is set to the predefined brightness value. It is important that the configured value does not undershoot the set minimum brightness (if present) or exceed the maximum brightness.

- Set the parameter to "Switch off".

The dimming channel is switched off when the bus voltage returns.

- Set parameter to "Brightness before bus voltage failure".

After the bus voltage returns, the brightness value set last before the bus voltage failure and internally stored in case of a bus voltage failure will be tracked.

- Set the parameter to "No reaction".

When the bus voltage returns, the dimming channel shows no reaction and remains in the brightness state currently selected or is switched off.

i In all settings: When the bus voltage is switched on, the brightness value is set to "0%" if no mains voltage is switched on at the load outputs when the bus voltage returns.

i Setting "Brightness before bus voltage failure": An ETS programming operation of the application or the parameter resets the stored switching state to "OFF - 0".

i In the "No reaction" setting: When the bus voltage returns, the corresponding dimming channel shows no response and remains in the brightness state last selected.

i The actuator briefly initialises after switching on the mains voltage at the load output each time. Dimming channels whose load type is configured to "Universal" calibrate themselves to the load. The calibration procedure becomes noticeable during ohmic loads by a brief flicker and lasts up to 10 seconds depending on the network conditions.

i If a switching state and brightness value are set after the bus voltage returns, they will be tracked in the feedback objects. Actively transmitting feedback objects first transmit, however, after bus voltage return, when the initialisation of the actuator has finished, and if necessary the "Delay time after bus voltage return" has elapsed.

i In the case of forced position as supplementary function: The communication object of the forced position can be initialised separately after the bus voltage returns. This has an effect on the reaction of the dimming channel when the

forced position is activated when the bus voltage returns. The configured "Behaviour on bus voltage return" is only executed when no forced position after a bus voltage return is activated!

- i** In the case of enabling function as supplementary function: Active disabling functions are always inactive after the bus voltage returns.
- i** When the bus voltage returns, a manual control will be interrupted.

10.10.1 Reset and initialisation behaviour parameter

Dimming channel ... -> DO... - General -> Reset behaviour

| | |
|---------------------------------|---|
| After ETS programming operation | Brightness value Switch off no reaction as when bus voltage returns |
|---------------------------------|---|

The actuator permits setting the brightness value separately for each dimming channel after programming with the ETS.

Brightness value: The channel restores the brightness value defined with the following parameter.

Switch-off: After an ETS programming operation, the channel is switched off.

No reaction: After an ETS programming operation, the actuator retains the current brightness value.

like after the bus voltage returns: After an ETS programming operation, the actuator behaves as specified in the parameter "After bus voltage returns".

| | |
|------------------|---|
| Brightness value | Basic brightness 5% 10% ... 100% |
|------------------|---|

This parameter defines the brightness value to be set after an ETS programming operation. The value must always be between the upper and lower brightness limit value of the dimming range.

The selection of "Basic brightness" is not necessary when using a minimum brightness.

This parameter is visible only in the "Brightness value" setting

| | |
|--------------------------------|--|
| In case of bus voltage failure | Brightness value Switch off no reaction |
|--------------------------------|--|

The actuator permits setting the brightness value separately for each dimming channel in case of bus voltage failure.

Brightness value: The channel restores the brightness value defined with the following parameter.

Switch-off: The channel is switched off in case of bus voltage failure.

No reaction: In case of bus voltage failure, the actuator retains the current brightness value.

| | |
|---|--|
| Brightness value | Basic brightness 5% 10% ... 100% |
| <p>This parameter defines the brightness value to be set in case of bus voltage failure. The value must always be between the upper and lower brightness limit value of the dimming range.</p> <p>The selection of "Basic brightness" is not necessary when using a minimum brightness.</p> <p>This parameter is visible only in the "Brightness value" setting</p> | |
| After the bus voltage returns | Brightness value Switch off Brightness before bus voltage failure no reaction Activating staircase function |
| <p>The actuator allows the brightness value to be set separately for each dimming channel after the bus voltage returns.</p> <p>Brightness value: The channel restores the brightness value defined with the following parameter.</p> <p>Switch-off: The channel is switched off after the bus voltage returns.</p> <p>Brightness before bus voltage failure: After the bus voltage returns, the actuator restores the brightness value last stored during the bus voltage failure.</p> <p>No reaction: The actuator retains the current brightness value when the bus voltage returns.</p> <p>Activate staircase function: The staircase function is – irrespective of the "Switching" object - activated after the bus voltage returns. This setting is only available when the staircase function is enabled.</p> | |
| Brightness value | Basic brightness 5% 10% ... 100% |
| <p>This parameter defines the brightness value to be set after the bus voltage returns. The value must always be between the upper and lower brightness limit value of the dimming range.</p> <p>The selection of "Basic brightness" is not necessary when using a minimum brightness.</p> <p>This parameter is visible only in the "Brightness value" setting</p> | |

10.11 Channel-oriented feedback

The actuator can track the current switching state and brightness value of a dimming channel, the type of the connected load and any possible error states via separate feedback objects and can also transmit them to the bus, if the bus voltage is on. The following feedback objects can be enabled independently of each other for each channel ...

- Feedback switching status (1-bit)
- Feedback brightness value (1-byte)
- Short-circuit feedback (1-bit)
- Overload/mains voltage failure feedback (1-bit)
- Load type feedback (2 objects, 1-byte)

The actuator calculates the object value of the feedback objects during each switching or dimming procedure. The actuator tracks the switching state or brightness value and updates the feedback objects even when a dimming channel is activated by the manual operation or scene function.

10.11.1 Switching status feedback

The switching status feedback object is updated internally after the following events ...

- Immediately after switching on a dimming channel (if necessary, first after a switch-on delay has elapsed and at the beginning of a soft ON dimming procedure / also after a staircase function).
- After switching off a dimming channel (if necessary, first after a switch-off delay has elapsed and at the end of a soft OFF dimming procedure / also after a staircase function).
- Immediately after switching off by means of the automatic switch-off function.
- At the beginning of a dimming procedure when dimming on (relatively high dimming or brightness value = 1...100 %) a dimming channel.
- At the end of a dimming procedure when dimming off (brightness value = 0 %) a dimming channel.
- Only when the switching state changes (therefore not for dimming procedures that do not change the switching state e.g. from 10 % to 50 % brightness).
- During updating of the switching state from "ON" to "ON" when the dimming channel is already switched on.
- During updating of the switching state from "OFF" to "OFF" when the dimming channel is already switched off.
- Always at the start or end of a disabling or forced position function (only if the switching state changes as a result).
- Whenever the bus voltage returns, in the case of mains voltage failure ("OFF") or at the end of any ETS programming process (if necessary also delayed and after calibration of the load).

Activate switching status feedback

The switching status feedback can be used as an active message object or as a passive status object. As an active message object, the switching status feedback information is also directly transmitted to the KNX whenever the feedback value is updated. As a passive status object, there is no telegram transmission after an update. In this case, the object value must be read out. The ETS automatically sets the object communication flags required for proper functioning.

The parameter "Switching status" exists separately for each output on the parameter page "Dimming channel ... -> DO... - General -> Feedback telegrams". Feedback takes place via the "Switching feedback" object.

Prerequisite:

The feedback must be enabled on the parameter page "Dimming channel ... -> DO... - General -> Enabled functions".

- Set the parameter to "Feedback is active signalling object".

A switching status is transmitted as soon as it is updated. An automatic telegram transmission of the feedback takes place after the bus voltage returns or after programming with the ETS.

- Set the parameter to "Feedback is passive status object".

A switching status will be transmitted in response only if the feedback object is read out from by the KNX. No automatic telegram transmission of the feedback takes place after bus voltage return or after programming with the ETS.

- Set the parameter to "No reaction".

The switching status feedback of the affected dimming channel is deactivated.

i Feedback of the current switching status via the "Switching" object is not possible.

Set update of "Switching feedback"

In the ETS, you can specify when the actuator should update the feedback value for the switching status (object "Switching feedback") in case of an actively transmitting communication object. The object value updated by the actuator is then signalled actively to the KNX.

The parameter "Update of the object value" can be preset separately for each switching output on the parameter page "Dimming channel ... -> DO... - General -> Feedback telegrams".

Prerequisite:

The feedback must be enabled on the parameter page "Dimming channel ... -> DO... - General -> Enabled functions". In addition, the switching status feedback must be configured to actively transmitting.

- Set the parameter to "After each update object 'Switching'/'Central'".

The actuator updates the feedback value in the object once a new telegram is received on the input objects "Switching" or "Central switching" or the switching state changes internally (e. g. through a time function). With an actively

transmitting feedback object, a new telegram is also then actively transmitted to the KNX each time. The telegram value of the feedback does not necessarily have to change in the process. Hence, a corresponding switching status feedback is also generated on the "Switching" object such as in the case of cyclical telegrams for example.

- Set the parameter to "Only if the feedback value changes".

The actuator only updates the feedback value in the object if the telegram value (e. g. "OFF" to "ON") also changes or the switching state changes internally (e. g. through a time function). If the telegram value of the feedback does not change (e. g. in the case of cyclical telegrams to the "Switching" object with the same telegram value), the actuator does not transmit any feedback. Consequently, with an actively transmitting feedback object, no telegram with the same content will be transmitted repeatedly either.

This setting is recommendable, for instance, if the "Switching" and "Switching feedback" objects are linked to an identical group address. This is often the case when activating by means of light scene push-button sensors (recall and storage function).

Setting switching status feedback when bus voltage returns or after programming with the ETS

If used as active message object, the switching status feedback states are transmitted to the KNX after the bus voltage returns or after programming with the ETS. In these cases, the feedback can be delayed with the delay being collectively preset globally for all outputs.

- Activate the parameter "Delay after bus voltage return" on the parameter page "Dimming channel ... -> DO... - General ->Feedback telegrams".

The switching status telegram is transmitted with a delay after the bus voltage returns or after an ETS programming operation. No feedback telegram is transmitted during a running delay, even if the switching state changes during this delay.

- Deactivate the parameter.

The switching status telegram is transmitted immediately after the bus voltage returns or after an ETS programming operation.

Setting cyclical transmission of the switching status feedback telegram

The switching status feedback telegrams can, if actively transmitting, also be transmitted cyclically, in addition to the transmission after updating.

- Activate the parameter "Cyclical transmission" on the parameter page "Dimming channel ... -> DO... - General ->Feedback telegrams".

Cyclical transmission is activated. The cycle time for the switching status feedback can be configured separately for the parameter "Time for cyclical transmission".

- Deactivate the parameter.

Cyclical transmission is deactivated so that the feedback is transmitted to the KNX only when updated by the actuator.

10.11.2 Brightness value feedback

The brightness value feedback object is updated internally after the following events ...

- At the end of a relative (4-bit) or absolute (1-byte) dimming procedure.
- After switching on a dimming channel, if the switch-on brightness is set (if necessary, first after a switch-on delay has elapsed and at the end of a soft ON dimming procedure / also after a staircase function).
- After switching off a dimming channel (if necessary, first after a switch-off delay has elapsed and at the end of a soft OFF dimming procedure / also after a staircase function).
- Immediately after switching off by means of the automatic switch-off function.
- Only if the brightness value changes (if a brightness value specification undershoots the minimum brightness as a result of relative or absolute dimming from outside or exceeds the maximum brightness, the actuator does not update a brightness value feedback according to the minimum brightness or maximum brightness).
- Always at the start or end of a disabling or forced position function (only if the brightness value changes as a result).
- Whenever the bus voltage returns, in the case of mains voltage failure ("0") or at the end of any ETS programming process (if necessary also delayed and after calibration of the load).

i In the case of disabling function as supplementary function: A 'flashing' dimming channel is always signalled back as "Switched on" and with switch-on brightness. Switching status feedbacks are also transmitted for disabled channels when the channels are readjusted by a manual operation, for example.

Activate brightness value feedback

The brightness value feedback can be used as an active message object or as a passive status object. As an active signalling object, the brightness value feedback is also directly transmitted to the KNX for each update of the feedback value. As a passive status object, there is no telegram transmission after an update. In this case, the object value must be read out. The ETS automatically sets the object communication flags required for proper functioning.

The parameter "Brightness value" exists separately for each output on the parameter page "Dimming channel ... -> DO... - General -> Feedback telegrams". Feedback takes place via the "Brightness value feedback" object.

Prerequisite:

The feedback must be enabled on the parameter page "Dimming channel ... -> DO... - General -> Enabled functions".

- Set the parameter to "Feedback is active signalling object".

A brightness value is transmitted once this is updated. An automatic telegram transmission of the feedback takes place after the bus voltage returns or after programming with the ETS.

- Set the parameter to "Feedback is passive status object".

A brightness value is transmitted in response only if the feedback object is read out by the KNX. No automatic telegram transmission of the feedback takes place after bus voltage return or after programming with the ETS.

- Set the parameter to "No reaction".

The brightness value feedback of the affected dimming channel is deactivated.

Setting the update of the "Brightness value feedback"

In the ETS you can specify when the actuator should update the feedback value for the brightness value ("Brightness value feedback" object) in case of an actively transmitting communication object. The object value updated by the actuator is then signalled actively to the KNX.

The parameter "Update of the object value" can be preset separately for each output on the parameter page "Dimming channel ... -> DO... - General -> Feedback telegrams".

Prerequisite:

The feedback must be enabled on the parameter page "Dimming channel ... -> DO... - General -> Enabled functions". In addition, the brightness value feedback must be configured to actively transmitting.

- Set the parameter to "After each update 'Brightness value'/'Central brightness value' object".

The actuator updates the feedback value in the object once a new telegram is received on the input objects "Brightness value" or "Central brightness value" or the brightness value changes internally (e. g. through a time function). With an actively transmitting feedback object, a new telegram is also then actively transmitted to the KNX each time. The telegram value of the feedback does not necessarily have to change in the process. Hence, a corresponding brightness value feedback is also generated on the "brightness value feedback" object such as in the case of cyclical telegrams for example.

- Set the parameter to "Only if the feedback value changes".

The actuator only updates the feedback value in the object if the telegram value (e.g. "1 %" to "2 %") also changes or the brightness value changes internally (e.g. through a time function). If the telegram value of the feedback does not change (e. g. in the case of cyclical telegrams to the "Brightness value" object with the same telegram value), the actuator does not transmit any feedback. Consequently, with an actively transmitting feedback object, no telegram with the same content will be transmitted repeatedly either.

This setting is recommendable, for instance, if the "Brightness value" and "Brightness value feedback" objects are linked to an identical group address. This is often the case when activating by means of light scene push-button sensors (recall and storage function).

Setting feedback for when the mains voltage returns or for ETS programming

If used as active signalling object, the brightness value feedback states are transmitted to the KNX after the mains voltage returns or after ETS programming.

The feedback telegram can be transmitted with a time delay (parameter "Delay after mains voltage returns"). The delay is collectively preset globally for all outputs.

- i** No feedback is transmitted during a running time delay.

Setting cyclical transmission of the brightness value feedback

The brightness value feedback telegrams can, if active, also be transmitted cyclically, in addition to transmission after updating.

- Activate the parameter "Cyclical transmission" on the parameter page "Dimming channel ... -> DO... - General -> Feedback telegrams".

Cyclical transmission is activated. The cycle time for the brightness value feedback can be configured separately for the parameter "Time for cyclical transmission".

- Deactivate the parameter.

Cyclical transmission is deactivated so that the feedback is transmitted to the KNX only when updated by the actuator.

10.11.3 Short-circuit feedback

The short-circuit status feedback object is updated after the following events ...

- As soon as a short-circuit has been detected (after 7 seconds for trailing edge phase control, after 100 milliseconds for leading edge phase control), the message "Short circuit - 1" is displayed
- Whenever the bus voltage returns, in the event of a mains voltage failure on the load or at the end of an ETS programming operation (if necessary also delayed and after calibration of the load).

- i** Here, it is described how a short-circuit message is enabled and how the telegram transmission of this message behaves. The chapter "Troubleshooting" (see chapter "Troubleshooting" ▶ Page 13) describes in detail how to eliminate a fault.

Activating short-circuit feedback

The short-circuit feedback is an active signalling object. The short-circuit feedback is also directly transmitted to the KNX whenever the feedback value is updated. The parameter "Short-circuit" exists separately for each output on the parameter page "Dimming channel ... -> DO... - General -> Feedback telegrams". Feedback takes place via the "Short-circuit feedback" object.

Prerequisite:

The feedback must be enabled on the parameter page "Dimming channel ... -> DO... - General -> Enabled functions".

- Enable the "Short-circuit" parameter.

The short-circuit feedback is transmitted once this is updated. An automatic telegram transmission of the feedback takes place after the bus voltage returns or after programming with the ETS.

Setting short-circuit feedback messages for when the bus voltage returns or ETS programming

The short-circuit feedback states are transmitted to the KNX after bus voltage return or after an ETS programming operation. The feedback can be delayed with the delay being collectively preset globally for all outputs.

- Activate the parameter "Delay after bus voltage return" on the parameter page "Dimming channel ... -> DO... - General ->Feedback telegrams".

The short-circuit feedback is transmitted with a delay after bus voltage return or after an ETS programming operation. No feedback is transmitted during a delay, even if the state changes during this delay.

- Deactivate the parameter.

The short-circuit feedback is transmitted immediately after bus voltage return or after an ETS programming operation.

10.11.4 Overload/mains voltage failure feedback

The overload/mains voltage failure feedback object is updated after the following events ...

- As soon as a failure of the mains voltage supply of a load output has been detected, the message "Overload/mains voltage failure present - 1" is displayed.
- As soon as a return of the mains voltage supply of a load output has been detected, the message "No overload/no mains voltage failure present - 0" is displayed.
- As soon as the overtemperature protection switches off the output due to an overload, the message "Overload/mains voltage failure present - 1" is displayed.
- As soon as the overtemperature protection has been reset automatically or manually after sufficient cooling, the message "No overload/no mains voltage failure present - 0" is displayed.

i Here, it is described how an overload/mains voltage failure message is enabled and how the telegram transmission of this message behaves. The chapter "Troubleshooting" (see chapter "Troubleshooting" ▶ Page 13) describes in detail how to eliminate a fault.

Activating overload/mains voltage failure feedback

The overload/mains voltage failure feedback is an active signalling object. The overload/mains voltage failure feedback is also directly transmitted to the KNX whenever the feedback value is updated. The parameter "Overload/mains voltage failure" exists separately for each output on the parameter page "Dimming channel ... -> DO... - General -> Feedback telegrams". Feedback takes place via the "Overload/mains voltage failure feedback" object.

Prerequisite:

The feedback must be enabled on the parameter page "Dimming channel ... -> DO... - General -> Enabled functions".

- Enable the parameter "Overload/mains voltage failure".

The overload/mains voltage failure feedback is transmitted once this is updated. An automatic telegram transmission of the feedback takes place after the bus voltage returns or after programming with the ETS.

Setting overload/mains voltage failure feedback for bus voltage return or ETS programming

The overload/mains voltage failure feedback states are transmitted to the KNX after the bus voltage returns or after an ETS programming operation. The feedback can be delayed with the delay being collectively preset globally for all outputs.

- Activate the parameter "Delay after bus voltage return" on the parameter page "Dimming channel ... -> DO... - General ->Feedback telegrams".

The overload/mains voltage failure feedback states are transmitted with a delay after bus voltage return or after an ETS programming operation. No feedback is transmitted during a delay, even if the state changes during this delay.

- Deactivate the parameter.

The overload/mains voltage failure feedback is transmitted immediately after the bus voltage returns or after an ETS programming operation.

10.11.5 Load type feedback

For each dimming output, the actuator has the option of reporting the current load type. The data format of the load type feedback can be configured in the ETS (KNX-compliant or extended).

The load type feedback objects are updated in the event of the following events:

- Always when the bus voltage returns,
- When the mains voltage returns to the load,
- At the end of an ETS programming operation.

Activating load type feedback

The load type feedback is an active signalling object. The load type feedback is also directly transmitted to the KNX whenever the feedback value is updated. The parameter "Load type" exists separately for each output on the parameter page "Dimming channel ... -> DO... - General -> Feedback telegrams". Feedback takes place via one of the "Load type feedback" objects.

Prerequisite:

The feedback must be enabled on the parameter page "Dimming channel ... -> DO... - General -> Enabled functions".

- Enable the parameter "Load type".
- Set the "Type of feedback" parameter

The load type feedback is transmitted once this is updated. An automatic telegram transmission of the feedback takes place after the mains voltage returns to a load output, bus voltage return or after an ETS programming operation.

10.11.6 Feedback telegrams parameter

Dimming channel ... -> DO... - General -> Enabled functions

| | |
|--|---------------------|
| Feedback | Checkbox (yes / no) |
| This parameter can be used to disable or to enable the feedback functions. | |

Dimming channel ... -> DO... - General -> Feedback telegrams

| | |
|------------------|---|
| Switching status | no feedback feedback is active signalling object Feedback is passive status object |
|------------------|---|

The current switching state of the dimming output can be reported separately back to the KNX.

No feedback: The switching status feedback of the affected dimming channel is deactivated.

Feedback is active signalling object: A switching status is transmitted as soon as it is updated. An automatic telegram transmission of the feedback takes place after the bus voltage returns or after programming with the ETS.

Feedback is passive status object: A switching status will be transmitted in response only if the feedback object is read out by the KNX. No automatic telegram transmission of the feedback takes place after bus voltage return or after programming with the ETS.

| | |
|------------------------------|---|
| Updating of the object value | after each update object "Switching"/"Central" only if the feedback value changes |
|------------------------------|---|

Here, you can specify when the actuator should update the feedback value for the switching status (object "Switching feedback") in case of an actively transmitting communication object. The object value updated by the actuator is then signalled actively to the KNX.

This parameter is only visible in case of an actively transmitting feedback.

after each update object "Switching"/"Central": The actuator updates the feedback value in the object once a new telegram is received on the input objects "Switching" or "Central switching" or the switching state changes internally (e. g. through a time function). With an actively transmitting feedback object, a new telegram is also then actively transmitted to the KNX each time. The telegram value of the feedback does not necessarily have to change in the process. Hence, a corresponding switching status feedback is also generated on the "Switching" object such as in the case of cyclical telegrams for example.

only if the feedback value changes: The actuator only updates the feedback value in the object if the telegram value (e. g. "OFF" to "ON") also changes or the switching state changes internally (e. g. through a time function). If the telegram value of the feedback does not change (e. g. in the case of cyclical telegrams to the "Switching" object with the same telegram value), the actuator does not transmit any feedback. Consequently, with an actively transmitting feedback object, no telegram with the same content will be transmitted repeatedly either.

| | |
|--|---|
| Delay after bus voltage returns | Checkbox (yes / no) |
| <p>The states of the switching status feedback can be transmitted to the KNX with a delay after the bus voltage returns or after an ETS programming operation. The activated parameter causes a delay when the bus voltage returns. The delay time is configured on the "General" parameter page.</p> <p>This parameter is only visible in case of an actively transmitting feedback.</p> | |
| Cyclical transmission | Checkbox (yes / no) |
| <p>The switching status feedback telegrams can, if actively transmitting, also be transmitted cyclically, in addition to the transmission after updating.</p> <p>This parameter is only visible in case of an actively transmitting feedback.</p> <p>Parameter activated: Cyclical transmission is activated.</p> <p>Parameter deactivated: Cyclical transmission is deactivated so that the feedback is transmitted to the KNX only when updated by the actuator.</p> | |
| Brightness value | no feedback feedback is active signalling object Feedback is passive status object |
| <p>The current brightness value of the dimming output can be reported back separately to the KNX.</p> <p>No feedback: The brightness value feedback of the affected dimming channel is deactivated.</p> <p>Feedback is active signalling object: The brightness value is transmitted as soon as it is updated. An automatic telegram transmission of the feedback takes place after the bus voltage returns or after programming with the ETS.</p> <p>Feedback is passive status object: The brightness value will be transmitted in response only if the feedback object is read out by the KNX. No automatic telegram transmission of the feedback takes place after bus voltage return or after programming with the ETS.</p> | |

| | |
|---|---|
| Updating of the object value | after each update "Brightness value"/"Central brightness value" object only if the feedback value changes |
| <p>Here, you can specify when the actuator should update the feedback value for the switching status (object "Brightness value feedback") in case of an actively transmitting communication object. The object value updated by the actuator is then signalled actively to the KNX.</p> <p>This parameter is only visible in case of an actively transmitting feedback.</p> <p>after each update "Brightness value"/"Central brightness value" object: The actuator updates the feedback value in the object once a new telegram is received on the "Brightness value" or "Central brightness value" input objects or once the value changes internally (e.g. due to a dimming function). With an actively transmitting feedback object, a new telegram is also then actively transmitted to the KNX each time. The telegram value of the feedback does not necessarily have to change in the process. Hence, a corresponding brightness value feedback is also generated on the "Brightness value" object such as in the case of cyclical telegrams for example.</p> <p>only if the feedback value changes: The actuator only updates the feedback value in the object if the brightness value also changes or the switching state changes internally (e. g. through a time function). If the telegram value of the feedback does not change (e. g. in the case of cyclical telegrams to the "Brightness value" object with the same telegram value), the actuator does not transmit any feedback. Consequently, with an actively transmitting feedback object, no telegram with the same content will be transmitted repeatedly either.</p> | |
| Delay after bus voltage returns | Checkbox (yes / no) |
| <p>The states of the brightness value feedback can be transmitted to the KNX with a delay after the bus voltage returns or after an ETS programming operation. The activated parameter causes a delay when the bus voltage returns. The delay time is configured on the "General" parameter page.</p> <p>This parameter is only visible in case of an actively transmitting feedback.</p> | |
| Cyclical transmission | Checkbox (yes / no) |
| <p>The brightness value feedback telegrams can, if active, also be transmitted cyclically, in addition to transmission after updating.</p> <p>This parameter is only visible in case of an actively transmitting feedback.</p> <p>Parameter activated: Cyclical transmission is activated.</p> <p>Parameter deactivated: Cyclical transmission is deactivated so that the feedback is transmitted to the KNX only when updated by the actuator.</p> | |
| Time for cyclical transmission | 0...23 h 0 ... 2 ... 59 min 0 ... 59 s |
| <p>These parameters define the time for cyclic transmission of switching status feedback and brightness value feedback.</p> <p>Setting the cycle time. These parameters are only available if cyclic transmission is activated for the switching status or brightness value.</p> | |

| | |
|--|---|
| Short-circuit | Checkbox (yes / no) |
| This parameter enables the short-circuit feedback object. | |
| Delay after bus voltage returns | Checkbox (yes / no) |
| The states of the short-circuit feedback can be transmitted to the KNX with a delay after the bus voltage returns or after an ETS programming operation. The activated parameter causes a delay when the bus voltage returns. The delay time is configured on the "General" parameter page. | |
| Overload/mains voltage failure | Checkbox (yes / no) |
| This parameter enables the overload/mains voltage failure feedback object. | |
| Delay after bus voltage returns | Checkbox (yes / no) |
| The states of the overload/mains voltage failure feedback can be transmitted to the KNX with a delay after the bus voltage returns or after an ETS programming operation. The activated parameter causes a delay when the bus voltage returns. The delay time is configured on the "General" parameter page. | |
| Load type | Checkbox (yes / no) |
| For each dimming output, the actuator has the option of reporting the current load type. This parameter enables the load type feedback. | |
| Type of feedback | Standard (KNX compliant) Extended |
| The data format of the load type feedback is specified here. Standard (KNX-compliant): The load type feedback takes place in the standardised data format according to DPT 20.610. Extended: The feedback of the load type is bit-oriented: "0" = undefined (no calibration possible because of missing mains voltage / short circuit) / "1" = trailing edge phase control (set by parameter) / "2" = leading edge phase control (set by parameter) / "3" = universal, calibrated to capacitive or resistive load / "4" = universal, calibrated to inductive load / "5" ... "255" not used | |

10.11.7 Object list for feedback

| Object no. | Function | Name | Type | DPT | Flag |
|---|------------------------------------|---------------------------------------|--------|--------|---------------|
| 32, 52, 72, 92 | Switching feedback | Dimming channel ... (...) - Output | 1-bit | 1,001 | C, R, -, T, A |
| 1-bit object for feedback signalling of the switching state ("1" = on / "0" = off) to the bus. | | | | | |
| Object no. | Function | Name | Type | DPT | Flag |
| 36, 56, 76, 96 | Feedback brightness value | Dimming channel ... (...) - Output | 1-byte | 5,001 | C, R, -, T, A |
| 1-byte object for feedback signalling of an absolute dimming value (brightness value 0...255) to the bus. | | | | | |
| Object no. | Function | Name | Type | DPT | Flag |
| 191, 197, 203, 209 | Feedback load type (KNX compliant) | Dimming channel ... (...) - Output | 1-byte | 20,610 | C, R, -, T, A |
| 1-byte object for signalling the current load type to the bus. "0" = undefined "1" = leading edge phase control "2" = trailing edge phase control "3" ... "255" not used The object is only available if the parameter "Type of feedback" is set to "Standard (KNX-compliant)". | | | | | |
| Object no. | Function | Name | Type | DPT | Flag |
| 192, 198, 204, 210 | Feedback load type (extended) | Dimming channel ... (...) - Output | 1-byte | | C, R, -, T, A |
| 1-byte object for signalling the current load type to the bus. "0" = undefined (no calibration possible because mains voltage absent / short-circuit) "1" = trailing edge phase control (set by parameter) "2" = leading edge phase control (set by parameter) "3" = universal, adjusted to capacitive or ohmic load "4" = universal, adjusted to inductive load "5" ... "255" not used The object is only available if the parameter "Type of feedback" is set to "Extended". | | | | | |
| Object no. | Function | Name | Type | DPT | Flag |
| 193, 199, 205, 211 | Feedback short-circuit | Dimming channel ... (...) - Output | 1-bit | 1,005 | C, R, -, T, A |
| 1-bit object for signalling a short-circuit in relation to the dimming channel ("1" = short-circuit present/"0" = short-circuit not present). | | | | | |

| Object no. | Function | Name | Type | DPT | Flag |
|--|---|---------------------------------------|-------|-------|---------------|
| 194, 200, 206, 212 | Feedback overload / mains voltage fail- ure | Dimming channel ... (...) - Output | 1-bit | 1,005 | C, R, -, T, A |
| 1-bit object for signalling an overload or mains voltage failure in relation to the dimming channel ("1" = overload/mains voltage failure present/"0" = overload/mains voltage failure not present). | | | | | |

10.12 Collective feedback switching status

After central commands or after the bus voltage returns, a KNX line is generally heavily loaded by data traffic as many bus devices are actively transmitting the state of their communication objects by means of feedback telegrams. This effect occurs particularly when using visualisations. Collective feedback for switching states can be used to keep the telegram load low during initialisation.

In the collective feedback, the switching states of all dimming outputs are combined in one communication object. The 32-bit communication object "Dimming channels 1 ... 4 - Collective feedback" contains bit-orientated feedback information of the individual outputs.

The datapoint type of the collective feedback corresponds to the KNX standard (DPT 27.001). This could be used in suitable visualisation applications - for example in public buildings such as schools or hospitals - where the switching states of the entire actuator system are displayed centrally and no separate switching state indication is provided at the control panels. In such applications the collective feedback can replace the 1-bit individual feedbacks and thereby significantly reduce the KNX bus load.

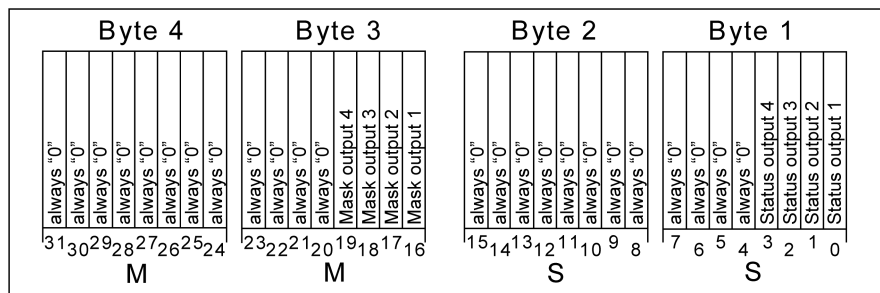

Figure 13: Object structure "23" of the collective feedback for outputs 1 ... 4

The collective feedback displays 4 different switching states. In so doing, each output possesses a bit, which signals the switching state ("S-bit), and an additional bit, which defines the masking ("M"-bit). The "S"-bits correspond to the logical non-inverted switching states of the outputs and are either "1" (switched on) or "0" (switched off).

The "M"-bits are "1" if this output is available on the actuator, i. e. the channel configuration provides this output. Similarly, the "M"-bits are "0" if the corresponding output is not available on the actuator or a parallel connection of the outputs is configured. In the latter cases, the corresponding "S"-bits are continuously "0" because there is no switching status.

- i** A "flashing" output (see "Disabling function") is always reported as "switched on".

Activate collective feedback and configure the feedback type

The collective feedback can be used as an active message object or as a passive status object. As an active message object, the collective feedback is transmitted to the KNX whenever a switching state changes or is updated (depending on the para-

meter "Update of the object value"). In the function as a passive status object, there is no automatic telegram transmission. In this case, the object value must be read out. The ETS automatically sets the object communication flags required for proper functioning.

- Activate the parameter "Collective feedback" on the parameter page "General".

Collective feedback is enabled. The communication object and others parameters become visible.

- Set the parameter "Type of feedback" to "Active signalling object".

The collective feedback is transmitted once the status is updated. An automatic telegram transmission of the feedback takes place after the bus voltage returns or after programming with the ETS.

- Set the parameter to "Passive status object".

The collective feedback will be transmitted in response only if the feedback object is read out from by the KNX. No automatic telegram transmission of the feedback takes place after bus voltage return or after programming with the ETS.

Setting the update of collective feedback

In the ETS, you can specify when the actuator should update the feedback value for the collective feedback in case of an actively transmitting communication object. The object value updated by the actuator is then signalled actively to the KNX.

Prerequisite:

Collective feedback must be enabled. In addition, the feedback must be configured to actively transmitting.

- Set the parameter "Update of the object value" to "On each update object 'Switching'/'Central'".

The actuator updates the feedback value in the object once a new telegram is received on the input objects "Switching" or "Switching central function..." or the switching state changes internally (e. g. through a time function). A new telegram is also then actively transmitted to the KNX each time. The telegram value of the feedback does not necessarily have to change in the process. Hence, corresponding collective feedback is also generated on a switching object such as in the case of cyclical telegrams, for example.

- Set the parameter to "Only if the feedback value changes".

The actuator only updates the feedback value in the object if the telegram value (e. g. "OFF" to "ON") also changes or the switching state changes internally (e. g. through a time function). If the telegram value of the feedback does not change (e. g. in the case of cyclical telegrams to the "Switching" object with the same telegram value), the actuator does not transmit any feedback. Consequently, with an actively transmitting feedback object, no telegram with the same content will be transmitted repeatedly either.

Setting collective feedback when the bus voltage returns or after programming with the ETS

If used as active message object, the collective feedback is transmitted to the KNX after bus voltage return or after programming with the ETS. In these cases, the feedback can be time-delayed with the time delay being set globally.

Prerequisite:

Collective feedback must be enabled. In addition, the feedback must be configured to actively transmitting.

- Activate the parameter "Delay after bus voltage returns" of the collective feedback.

The collective feedback telegram is transmitted with a delay after the bus voltage returns or after an ETS programming operation. No feedback telegram is transmitted during a running delay, even if a switching state changes during the delay.

- Deactivate the parameter "Delay after bus voltage returns" of the collective feedback.

The collective feedback telegram is transmitted immediately after the bus voltage returns or after an ETS programming operation.

Setting the cyclical transmission of the collective feedback

The telegram of the collective feedback can also be transmitted cyclically, in addition to transmission on a change or update.

Prerequisite:

Collective feedback must be enabled. In addition, the feedback must be configured to actively transmitting.

- Activate the "Cyclical transmission" parameter. Configure the cycle time for the parameter "Time for cyclical transmission".

Cyclical transmission is activated. The collective feedback is transmitted to the KNX cyclically and if one of the switching states changes or is updated.

- Deactivate the "Cyclical transmission" parameter.

Cyclical transmission is deactivated, which means that the collective feedback is only transmitted to the KNX if one of the switching states changes or is updated.

- i** During an active delay after the bus voltage returns, no collective feedback will be transmitted even if a switching state changes.

10.12.1 General collective feedback parameter

General -> Collective feedback switching status

| | |
|---|---|
| Collective feedback | Checkbox (yes / no) |
| Only if this function is active, the object "Dimming channels ... - Collective feedback" and further parameters is displayed. | |
| Type of feedback | active signalling object passive status object |
| <p>The current switching state of the collective feedback can be reported back to the KNX.</p> <p>active signalling object: A status is transmitted as soon as it is updated. An automatic telegram transmission of the feedback takes place after the bus voltage returns or after programming with the ETS.</p> <p>passive status object: A status will be transmitted in response only if the feedback object is read out by the KNX. No automatic telegram transmission of the feedback takes place after bus voltage return or after programming with the ETS.</p> | |
| Updating the object value | after each update "Switching"/"Central" object Only if the feedback value changes |
| <p>Here, you can specify when the actuator should update the feedback value for the switching status (object "Switching feedback") in case of an actively transmitting communication object. The object value updated by the actuator is then signalled actively to the KNX. This parameter is only visible in case of an actively transmitting feedback.</p> <p>after each update object "Switching"/"Central": The actuator updates the feedback value in the object once a new telegram is received on the input objects "Switching" or "Central switching" or the switching state changes internally (e. g. through a time function). With an actively transmitting feedback object, a new telegram is also then actively transmitted to the KNX each time. The telegram value of the feedback does not necessarily have to change in the process. Hence, a corresponding switching status feedback is also generated on the "Switching" object such as in the case of cyclical telegrams for example.</p> <p>only if the feedback value changes: The actuator only updates the feedback value in the object if the telegram value (e. g. "OFF" to "ON") also changes or the switching state changes internally (e. g. through a time function). If the telegram value of the feedback does not change (e. g. in the case of cyclical telegrams to the "Switching" object with the same telegram value), the actuator does not transmit any feedback. Consequently, with an actively transmitting feedback object, no telegram with the same content will be transmitted repeatedly either.</p> | |
| Delay when bus voltage returns | Checkbox (yes / no) |
| <p>The state of the switching status feedback can be transmitted to the KNX with a delay when the bus voltage returns or after an ETS programming operation. The activated parameter causes a delay when the bus voltage returns. The delay time is configured on the parameter page "General -> Times".</p> <p>This parameter is only visible in case of an actively transmitting feedback.</p> | |

| | |
|--|--|
| Cyclical transmission | Checkbox (yes / no) |
| <p>The switching status feedback telegrams can, if actively transmitting, also be transmitted cyclically, in addition to the transmission after updating.</p> <p>This parameter is only visible in case of an actively transmitting feedback.</p> <p>Parameter activated: Cyclical transmission is activated.</p> <p>Parameter deactivated: Cyclical transmission is deactivated so that the feedback is transmitted to the KNX only when updated by the actuator.</p> | |
| Time for cyclical transmission | 0...23 h 0...2...59 min 0...59 s |
| <p>These parameters jointly define the time for cyclical transmission of the switching status feedback.</p> <p>These parameters are only available if cyclical transmission is activated.</p> | |

10.12.2 Object list collective feedback

| Object no. | Function | Name | Type | DPT | Flag |
|--|---------------------------|---|--------|--------|---------------|
| 23 | Feedback switching status | Dimming channels 1 ... 4 - Collective feedback - Output | 4-byte | 27,001 | C, R, -, T, A |
| <p>4-byte object for collective status feedback of the states for outputs 1...4. In the collective feedback, the switching states are combined in only one telegram. The object contains bit-orientated feedback information. The object can be actively transmitting or passively read out (parameter-dependent).</p> | | | | | |

10.13 Time delays

Up to two time functions can be preset for each dimming output, independently of each other. The time functions affect the communication objects "Switching" or "Central switching" only (if at least one of the central functions is activated for the output concerned) and delay the object value received depending on the telegram polarity.

- i** At the end of a disabling function or forced position function, the switching state received during the function or set before the function can be tracked. Residual times of time functions are also tracked if these had not yet fully elapsed at the time of the reactivation or forced control.
- i** The time delays do not influence the staircase function if this is enabled.
- i** A time delay still in progress will be fully aborted by a reset of the actuator (bus voltage failure or ETS programming).

Activating switch-on delay

The switch-on delay can be activated separately in the ETS for each dimming output.

Prerequisite:

The time delays must be enabled on the parameter page "Dimming channel ... -> DO... - General -> Enabled functions".

- Activate the checkbox "Switch-on delay". Configure the desired switch-on delay.

The switch-on delay is enabled. After receipt of an ON telegram via the "Switching" or "Central switching" object, the configurable time is started. Another ON-telegram triggers the time only when the parameter "Switch-on delay retriggerable" is activated. An OFF-telegram received during the switch-on delay will end the delay and set the switching status to "OFF".

Activating switch-off delay

The switch-off delay can be activated separately in the ETS for each dimming output.

Prerequisite:

The time delays must be enabled on the parameter page "Dimming channel ... -> DO... - General -> Enabled functions".

- Activate the checkbox "Switch-off delay". Configure the desired switch-off delay.

The switch-off delay is enabled. After reception of an OFF telegram via the "Switching" or "Central switching" object, the configurable time is started. Another OFF-telegram triggers the time only when the parameter "Switch-off delay retriggerable" is activated. An ON-telegram received during the switch-off delay will end the delay and set the switching status to "ON".

10.13.1 Time delays parameters

Dimming channel ... -> DO... - General -> Enabled functions

| | |
|--|---------------------|
| Time delays | Checkbox (yes / no) |
| This parameter can be used to disable or to enable the time delays. The parameter is deactivated if cyclical monitoring is enabled. | |

Dimming channel ... -> DO... - General -> Time delays

| | |
|--|---------------------|
| Switch-on delay | Checkbox (yes / no) |
| The communication objects "Switching" or "Central switching" can be evaluated after a time delay. This parameter enables the switch-on delay and thereby activates the necessary parameters. | |

| | |
|---|-----------------------------|
| Delay time | 0...59 min 0...10...59 s |
| This parameter is used for setting the duration of the switch-on delay. | |

| | |
|--|---------------------|
| Switch-on delay retriggerable | Checkbox (yes / no) |
| A switch-on delay still in progress can be retriggered by another "ON" telegram (parameter activated). Alternatively, the retriggering time (parameter deactivated) can be suppressed. The parameters for the switch-on delay are only visible if switch-on delay or switch-on and switch-off delay are activated. | |

| | |
|---|---------------------|
| Switch-off delay | Checkbox (yes / no) |
| The communication objects "Switching" or "Central switching" can be evaluated after a time delay. This parameter enables the switch-off delay and thereby activates the necessary parameters. | |

| | |
|--|-----------------------------|
| Delay time | 0...59 min 0...10...59 s |
| This parameter is used for setting the duration of the switch-off delay. | |

| | |
|---|---------------------|
| Switch-off delay retriggerable | Checkbox (yes / no) |
| A switch-off delay still in progress can be retriggered (parameter activated) by another "OFF" telegram. Alternatively, the retriggering time (parameter deactivated) can be suppressed. The parameters for the switch-off delay are only visible if switch-on delay or switch-on and switch-off delay are activated. | |

10.14 Switch-on/switch-off behaviour

10.14.1 Soft ON/OFF function

The soft-functions permit a dimming channel to be switched on or off at reduced speed when a switching command is received via the "Switching" or "Central switching" communication objects.

If the soft ON function is activated, a dimming procedure is executed until the switch-on brightness when switching on. This also occurs if the dimming channel is already switched on to a brightness value smaller than switch-on brightness. Likewise, with the soft OFF function, a dimming procedure is executed to 0 % brightness after receipt of an OFF telegram (see figure 14).

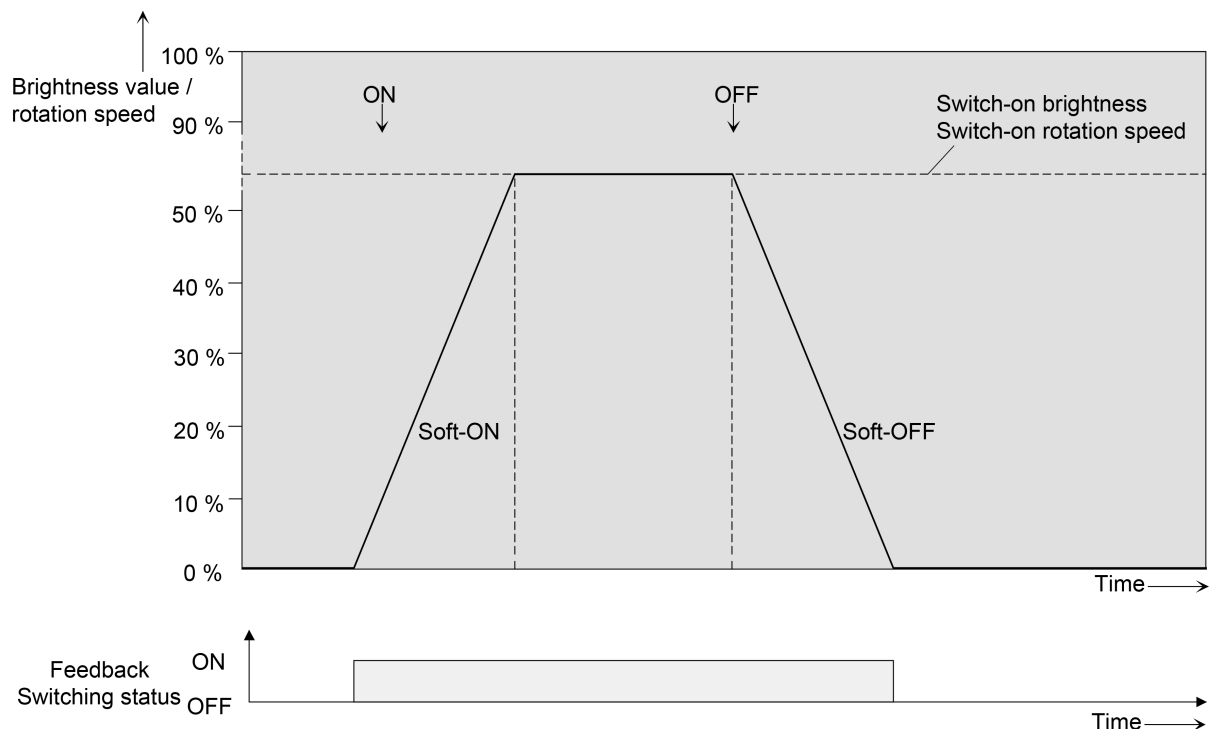

Figure 14: Dimming behaviour of the soft ON/OFF functions (as an example)

The dimming speeds can be configured separately in the ETS for the soft ON and soft OFF function. The relative dimming increment time between 2 of 255 dimming increments is configured directly.

The soft ON or soft OFF functions are not cannot be retrigged by the receipt of further switching telegrams while maintaining the switching status. The soft functions can be activated and configured separately in the ETS.

The soft functions also have effects on the switching edges of the staircase function.

- i** A dimming channel disabled via the bus can also flash for the disabling function depending on the ETS configuration. Dimming is not executed with the soft functions during ON and OFF flashing.

Enabling and setting soft ON function

The soft ON function can be set separately for each dimming channel in the ETS.

The switch-on/switch-off behaviour must be enabled on the parameter page "Dimming channel ... -> DO... - General -> Enabled functions".

- Set the parameter "Soft ON function ?" on the parameter page "Dimming channel ... -> DO... - General -> Switch-on/off behaviour".

The soft ON function is enabled. The parameter for the time between two dimming increments of the soft ON function becomes visible.

- Configure the parameter "Time for dimming increment soft ON" to the required dimming increment time.

Enabling and setting the soft OFF function

The soft ON function can be set separately for each dimming channel in the ETS.

The switch-on/switch-off behaviour must be enabled on the parameter page "Dimming channel ... -> DO... - General -> Enabled functions".

- Enable the parameter "Soft OFF function" on the parameter page "Dimming channel ... -> DO... - General -> Switch-on/off behaviour".

The soft OFF function is enabled. The parameter for the time between two dimming increments of the soft OFF function becomes visible.

- Configure the parameter "Time for dimming increment soft OFF" to the required dimming increment time.

10.14.2 Automatic switch-off

The switch-off function allows a dimming channel to be switched off automatically after a brightness value has been dimmed or jumped to and this new brightness value is below a switch-off brightness set in the ETS. A time delay can be configured optionally up to switching off.

The switch-off function is activated after reaching a constant brightness value, i. e. after a completed dimming procedure.

The automatic switch-off function, for example, not only makes it possible to set the lighting to basic brightness but to switch off as well by means of relative dimming. A further application, for example, is time-controlled "Good night switch-off" of a dimmed children's room lighting.

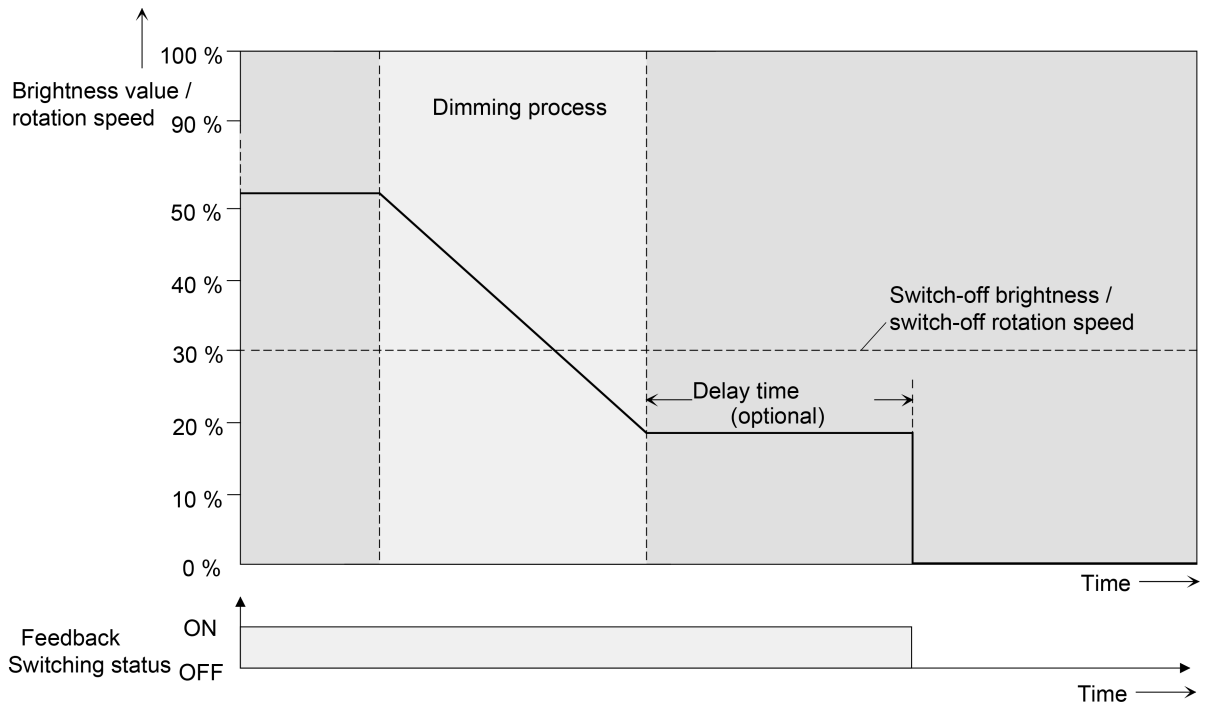

Figure 15: Dimming and switching behaviour of the automatic switch-off function

- i** Switching off always takes place without soft OFF function, i. e. jumping.
- i** The switch-off brightness in the dimmable brightness range can be set between basic and maximum brightness or minimum and maximum brightness. The switch-off function is always active if the switch-off brightness is configured to maximum brightness and the maximum brightness is randomly undershot.
- i** The feedback objects for switching state and brightness value are updated by the automatic switch-off function after switching off.

The automatic switch-off can firstly be activated by a dimming procedure initiated via the 4-bit ("Dimming") or 1-byte ("Brightness value") communication object. Secondly, the automatic switch-off can also be activated if a dimming channel is switched on (switch-on brightness < switch-off brightness) or a brightness is set by programming with the ETS or by a bus voltage return. The automatic switch-on can also be activated during a scene recall.

It should be noted that the disabling function or forced position function overrides the switch-off function (Figure 20). If the switch-off function is overridden, the actuator terminates the evaluation of the switch-off brightness.

Enabling automatic switch-off function

The automatic switch-off function can be set separately for each dimming channel in the ETS.

The switch-on/switch-off behaviour must be enabled on the parameter page "Dimming channel ... -> DO... - General -> Enabled functions".

- Enable the parameter "Automatic switch-off" on the parameter page "Dimming channel ... -> DO... - General -> Switch-on/off behaviour".

The automatic switch-off function is enabled and activated. Additional parameters become visible.

Setting the switch-off brightness

The switch-off brightness must be defined for the switch-off function. The switch-off brightness is set separately for each dimming channel in the ETS.

The switch-off function must be enabled in the ETS.

- Set the parameter "Switch off with brightness value lower than" on the parameter page "Dimming channel ... -> DO... - General -> Switch-on/switch-off behaviour" to the required brightness value.

Once a dimming procedure causes a value to fall below the parameterized switch-off brightness and once the brightness has been set to constant, the dimming channel concerned switches off or alternatively starts the delay until switching off.

- i** It should be noted that the configured value for the switch-off brightness is greater than any configured minimum brightness and less than the set maximum brightness (minimum brightness < switch-off brightness < maximum brightness)!
- i** Using the staircase function with pre-warning/continuous lighting: The reduced brightness of the pre-warning or continuous lighting does not start the switch-off function after reaching or undershooting the switch-off brightness!

Setting the delay of the switch-off function

A delay can be activated before the switch-off function switches-off automatically after undershooting the switch-off brightness at the end of a dimming procedure. The time for the delay can optionally be enabled separately for each dimming channel.

The switch-off function must be enabled in the ETS.

- Configure the parameter "Delay time" on the parameter page "Dimming channel ... -> DO... - General -> Switch-on/switch-off behaviour" to the required delay time.

Once a dimming procedure causes a value to fall below the parameterized switch-off brightness and once the brightness has been set to constant, the actuator triggers the delay time. The dimming channel concerned switches off for good once the delay time has elapsed. The delay time can be re-triggered by further dimming procedures.

10.14.3 Switch-on/switch-off behaviour parameter

Dimming channel ... -> DO... - General -> Enabled functions

| | |
|--|---------------------|
| Switch-on/switch-off behaviour | Checkbox (yes / no) |
| Setting the switch-on/switch-off behaviour can be disabled and enabled here. | |

Dimming channel ... -> DO... - General -> Switch-on/switch-off behaviour

| | |
|--|---------------------|
| Soft ON function | Checkbox (yes / no) |
| The soft ON function permits the dimming channel to be switched on more slowly. If this function is activated, a dimming operation to the switch-on brightness is executed after receiving a switch-on telegram via the "Switching" or "Central switching" object. | |

| | |
|---|--------------------------|
| Time between two dimming increments | 0...59 s 10... 990 ms |
| These parameters set the soft ON function for the dimming increment time. | |

| | |
|--|---------------------|
| Soft OFF function | Checkbox (yes / no) |
| The soft OFF function permits the dimming channel to be switched off more slowly. If this function is activated, a dimming operation to the brightness "0%" is executed after receiving a switch-off telegram via the "Switching" or "Central switching" object. | |

| | |
|--|--------------------------|
| Time between two dimming increments | 0...59 s 10... 990 ms |
| These parameters set the soft OFF function for the dimming increment time. | |

| | |
|---|---------------------|
| Automatic switch-off | Checkbox (yes / no) |
| The automatic switch-off function of the dimming channel can be activated here. If this function is activated, the connect load will switch off completely when a configurable brightness is undershot at the end of a dimming procedure, and if necessary, after a delay time has elapsed. | |

| | |
|---|------------------|
| Switch-off if brightness value smaller than | 5%, 10% ... 100% |
| This parameter defines the brightness, which, if undershot, will cause the dimming channel to be switched off at the end of a dimming procedure, or if necessary, after a delay time has elapsed. This parameter is visible only if the switch-off function is activated. | |

| | |
|--|---------------------|
| Delay until switch-off | Checkbox (yes / no) |
| The delay for the automatic switch-off function of the dimming channel can be activated here. If activated, the delay time can be set. | |

| | |
|--|---|
| Delay time | 0... 23 h 0...59 min 0... 30 ...59 |
| <p>This parameter sets the delay time of the switch-off function. If the switch-off brightness is undershot at the end of a dimming procedure, the dimming channel is switched off after the time set here has elapsed.</p> <p>The parameters for the time delay are visible only if the switch-off function is enabled.</p> | |

10.15 Scene function

Up to 64 scenes can be programmed and scene values stored separately for each dimming channel. The scene values are recalled or stored via a separate scene extension object. The data point type of the extension object allows all 64 scenes to be addressed.

The scene function must be enabled on the parameter page "Dimming channel ... -> DO... - General ->Enabled functions" for each dimming channel in order for the required communication objects and parameters (on the parameter page "Dimming channel ... -> DO... - General -> Scenes") to become visible.

The scene configuration selected in the parameterization decides whether the number of scenes is either variable (1 ... 64) or alternatively fixed to the maximum (64).

- Scene configuration = "Variable (1 ... 64 scenes)"
With this setting, the number of scenes used can be selected anywhere in the range 1 to 64. The parameter "Number of scenes" decides how many scenes are visible for the dimming channel in the ETS and can therefore be used. It is possible to specify which scene number (1 ... 64) controls each scene.
- Scene configuration = "Fixed (64 scenes)"
With this setting, all scenes are always visible and can therefore be used. The scenes are controlled via permanently assigned scene numbers (1 ... 64) (Scene number 1 -> Scene 1, Scene number 2 -> Scene 2 ...). If necessary, individual scenes can be deactivated.

The scene function can be combined together with other functions of a dimming channel, whereby the last received or preset state is always executed: Telegrams to the "Switching", "Dimming" or "Brightness value" objects, a scene recall or scene storage telegram at the time of an active staircase function aborts the staircase time prematurely and presets the brightness state according to the received object value (delays are also taken into account) or scene value. Similarly, the state of the dimming channel, which was preset by the "Switching", "Dimming" or "Brightness value" objects or by a scene recall, can be overridden by a staircase function.

Presetting a scene recall delay

Each scene recall of an dimming channel can optionally also be delayed. With this feature, dynamic scene sequences can be configured if several scene outputs are combined with cyclical scene telegrams.

Prerequisite

The scene function must be enabled on the parameter page "Dimming channel ... -> DO... - General -> Enabled functions".

- On the parameter page "Dimming channel ... -> DO... - General -> Scenes", activate the "Delay scene recall" parameter.

The delay time is now activated and can be configured separately. The delay only influences the scene recall of the dimming channel. The delay time is started on arrival of a recall telegram. The corresponding scene will be recalled and the brightness value set on the dimming channel only after this time has elapsed.

- i** Each scene recall telegram restarts the delay time and retriggers it. If a new scene recall telegram is received while a delay is active (scene recall not yet executed), the old (and not yet recalled scene) will be rejected and only the scene last received executed.
- i** The scene recall delay has no influence on the storage of scene values. A scene storage telegram within a scene recall delay terminates the delay and thus the scene recall.

Setting the behaviour during ETS programming

During storage of a scene, the brightness values are permanently stored internally in the device. To prevent the stored values from being replaced during ETS programming of the application or of the parameters by the originally programmed scene brightness values, the actuator can inhibit overwriting of brightness values. As an alternative, the original values can be reloaded into the device during each programming run of the ETS.

Prerequisite

The scene function must be enabled on the parameter page "Dimming channel ... -> DO... - General -> Enabled functions".

- On the parameter page "Dimming channel ... -> DO... - General -> Scenes", activate the parameter "Overwrite values stored in the device during the ETS programming operation".

During each ETS programming of the application or of the parameters, the scene brightness values parameterized in the ETS for the dimming channel concerned will be programmed into the actuator. Any scene brightness values stored in the device by means of a storage function will be overwritten.

- Deactivate the parameter "Overwrite values stored in the device during the ETS programming operation".

Scene brightness values stored in the device by means of a storage function will be maintained. If no scene brightness values have been stored, the brightness values last programmed in the ETS remain valid.

- i** When the actuator is commissioned for the first time, this parameter should be activated so that the brightness values are initialised to valid scene brightness values.

Setting scene numbers and scene switching states

The presetting of the scene number depends on the selected scene configuration. With variable configuration, the scene number (1...64) with which the scene is addressed, i. e. recalled or stored, must be determined for each scene of the dimming

channel. With a fixed scene configuration, the number of a scene is preset invariably. The data point type of the scene extension object permits addressing of up to 64 scenes max.

In addition to specifying the scene number, it is necessary to define which scene command (ON, OFF) should be set on the dimming channel during a scene recall.

Prerequisite

The scene function must be enabled on the parameter page "Dimming channel ... -> DO... - General -> Enabled functions".

- Only with variable scene configuration. On the parameter page "Dimming channel ... -> DO... - General -> Scenes", set the parameter for each scene to the numbers with which the scenes are to be addressed.

A scene can be addressed with the configured scene number. A setting of "0" deactivates the corresponding scene so that neither recalling nor storage is possible.

- Only with fixed scene configuration. On the parameter page "Dimming channel ... -> DO... - General -> Scenes" select or deselect the parameter "Scene active" if necessary.

Only selected scenes can be used. A deselected scene is deactivated and cannot be recalled or stored via the scene extension unit.

i If with variable scene configuration the same scene number is configured for several scenes, only the scene with the lowest sequential number will be addressed. The other scenes will be ignored in this case.

- On the parameter page "Dimming channel ... -> DO... - General -> Scenes", set the parameter "Brightness value" to the desired value for each scene.

During a scene recall, the parameterized brightness value is recalled and set on the dimming channel.

i The parameterized brightness value is adopted in the actuator during programming with the ETS only if the parameter "Overwrite values stored in the device during ETS download" is activated.

Setting the storage behaviour

The switching state set for the dimming channel can be stored internally via the extension object on receipt of a scene storage telegram. In this case, the switching state can be influenced before the storage by all functions of the dimming channel, provided that the individual functions have been enabled (e. g. also the disabling function, forced position function etc.).

Prerequisite

The scene function must be enabled on the parameter page "Dimming channel ... -> DO... - General -> Enabled functions".

- On the parameter page "Dimming channel ... -> DO... - General -> Scenes", activate the "Storage function" parameter for each scene.

The storage function is activated for the scene in question. On reception of a storage telegram via the "Scene extension unit" object, the current switching state will be internally stored.

- Deactivate the parameter "storage function" for each scene.

The storage function is deactivated for the scene in question. A storage telegram received via the "Scene extension unit" object will be rejected.

Configuring an extended scene recall

The extended scene recall allows calling of up to 64 scenes of a dimming channel in sequence. Here, scene recall takes place via the 1-bit communication object "Extended scene recall". Each ON telegram received via this object recalls the next of the available scenes in the configuration. Each OFF telegram received recalls the previous scene.

With the extended scene recall, the actuator always recalls the neighbouring scene - starting with the scene most recently recalled via the extended recall. It is irrelevant whether the scene is active on the appropriate dimming channel (scene number = "1...64" or scene active) or inactive (scene number = "0" or scene inactive). If an inactive scene is recalled via the extended scene recall, the appropriate dimming channel will not react.

Only the scenes available in the scene configuration can be selected via the extended scene recall (with "Variable" defined by the parameter "Number of scenes", with "Fixed" always all 64 scenes). After a reset (bus voltage return, ETS programming operation), an ON or OFF telegram always recalls scene 1 first.

i Recall of a scene via the 1-byte extension object does not influence the scene sequence of the extended scene recall. The two recall functions work independently of each other.

- Activate the parameter "Extended scene recall" on the parameter page "Dimming channel ... -> DO... - General -> Scenes".

The object "Extended scene recall" is available. Each ON telegram recalls the next scene. Each OFF telegram recalls the previous scene.

- Deactivate the parameter "Use extended scene recall".

The extended scene recall is deactivated. A scene recall can only take place via the 1-byte scene extension object.

The extended scene recall can take place with or without an overflow at the scene limits. An overflow occurs when the last scene of the selected configuration is reached when counting up or scene 1 when counting down and an additional telegram in the last counting direction is received by the actuator. The overflow behaviour is defined in the ETS.

- Activate the parameter "With overflow".

After reaching the last scene of the selected configuration, a further ON telegram of the overflow is executed and scene 1 is recalled. Similarly, after reaching scene 1, the overflow is executed by further OFF telegram and the last scene of the selected configuration is recalled.

- Deactivate the parameter "With overflow".

A scene overflow is not possible. After reaching the last scene of the selected configuration, further ON telegrams of the extended scene recall are ignored. In the same way, the actuator ignores further OFF telegrams if scene 1 was recalled last.

10.15.1 Scene function parameters

Dimming channel ... -> DO... - General -> Enabled functions

| | |
|--|---------------------|
| Scene function | Checkbox (yes / no) |
| This parameter can be used disable or to enable the scene function. The parameter is deactivated if cyclical monitoring is enabled. | |

Dimming channel ... -> DO... - General: -> Scenes

| | |
|--|---------------------|
| Delay scene recall | Checkbox (yes / no) |
| A scene is recalled via the scene extension object. If required, the scene recall can be delayed on reception of a recall telegram (parameter activated). The recall is alternatively made immediately on reception of the telegram (parameter deactivated). | |

| | |
|--|-----------------------------|
| Delay time | 0...59 min 0...10...59 s |
| These parameters specify the duration of the scene delay time. | |

| | |
|---|--|
| When scene is recalled | Jumping to brightness value Dimming to brightness value over dimming increment time Dimming brightness value via fading |
| When recalling a scene, the configured or stored scene value is set for the dimming channel concerned. This parameter setting can define whether the brightness value can be instantly jumped to or dimmed to or is set via fading. When fading, the brightness value to be set is reached in the exact configured fading time irrespective of the dimming characteristic of a channel and irrespective of which brightness value the dimming procedure was started at. Thus, for example, several dimming channels can be set to the same brightness at the same time. | |

| | |
|---|-------------------|
| Dimming increment time | 0 ... 5... 255 ms |
| Setting of the dimming increment time if the brightness value of a scene should be dimmed. This parameter is visible only if the parameter "Behaviour when recalling a scene" is set to "Dim to brightness value via dimming increment time". | |

| | |
|--|-------------------|
| Time for brightness value via fading | 0 ... 2 ... 240 s |
| Setting of the fading time if the brightness value of a scene should be dimmed to via fading. This parameter is visible only if the parameter "Behaviour when recalling a scene" is set to "Dim to brightness value via fading". | |

| | |
|--|---------------------|
| Visual feedback for storage function | Checkbox (yes / no) |
| <p>Optionally, a visual feedback via the dimming output can be signaled when executing a storage command. The channel flashes once as feedback in the configured flashing time.</p> <p>Parameter activated: When a storage function is executed, the visual feedback is activated immediately. The output switches to the opposite switching state for the duration of the configured flashing time and then back to the saved scene command.</p> <p>Parameter deactivated: When storing a scene, the visual feedback is not executed. The actuator adopts the current state of the output without special feedback.</p> | |
| Flashing time (1...10) | 1...5...10 |
| <p>The flashing time in which the visual feedback is to be executed is set here.</p> <p>This parameter is only visible when visual feedback is used.</p> | |
| Overwrite values stored in the device during the ETS programming operation | Checkbox (yes / no) |
| <p>During storage of a scene, the scene values (current states of the dimming outputs concerned) are stored internally in the device. To prevent the stored values from being replaced during ETS programming by the originally programmed scene values, the actuator can inhibit overwriting of the scene values (parameter deactivated). As an alternative, the original values can be reloaded into the device during each programming run of the ETS (parameter activated).</p> | |
| Use extended scene recall | Checkbox (yes / no) |
| <p>The extended scene recall allows calling of up to 64 scenes of a dimming channel in sequence. Here, scene recall takes place via the 1-bit communication object "Extended scene recall". Each ON telegram received via this object recalls the next scene. Each OFF telegram received recalls the previous scene.</p> <p>This parameter enables extended scene recall, if required.</p> | |
| With overflow | Checkbox (yes / no) |
| <p>The extended scene recall can take place with or without an overflow at the scene limits. An overflow occurs when the last scene of the selected configuration is reached when counting up or scene 1 when counting down and an additional telegram in the last counting direction is received by the actuator.</p> <p>Parameter activated: After reaching the last scene of the selected configuration, a further ON telegram of the overflow is executed and scene 1 is recalled. Similarly, after reaching scene 1, the overflow is executed by further OFF telegram and the last scene of the selected configuration is recalled.</p> <p>Parameter deactivated: A scene overflow is not possible. After reaching the last scene of the selected configuration, further ON telegrams of the extended scene recall are ignored. In the same way, the actuator ignores further OFF telegrams if scene 1 was recalled last.</p> <p>This parameter is only visible when the extended scene recall is used.</p> | |

| | |
|--|---|
| Scene configuration | variable (1...64 scenes) Fixed (64 scenes) |
| <p>The scene configuration selected here decides whether the number of scenes is either variable (1 ... 64) or alternatively fixed to the maximum (64).</p> <p>variable (1...64 scenes): In this setting, the number of scenes used can be selected anywhere within the range of 1 to 64. The parameter "Number of scenes" decides how many scenes are visible for the switching output in the ETS and can therefore be used. It is possible to specify which scene number (1 ... 64) controls each scene.</p> <p>fixed (64 scenes): With this setting, all scenes are always visible and can therefore be used. The scenes are controlled via permanently assigned scene numbers (1 ... 64) (Scene number 1 -> Scene 1, Scene number 2 -> Scene 2 ...). If necessary, individual scenes can be deactivated.</p> | |
| Number of scenes (1...64) | 1...10...64 |
| <p>This parameter is only available with variable scene configuration and defines how many scenes are visible for the dimming channel in the ETS and can therefore be used.</p> | |
| Scene number | 0...1*...64 *: The predefined scene number is dependent on the scene (1...64). |
| <p>With variable scene configuration, the number of scenes used can be selected anywhere in the range 1 to 64. It is then possible to preset which scene number (1 ... 64) controls each scene.</p> <p>A setting of "0" deactivates the corresponding scene so that neither recalling nor storage is possible. If the same scene number is configured for several scenes, only the scene with the lowest sequential number will be addressed. The other scenes will be ignored in this case.</p> <p>This parameter is only available with variable scene configuration.</p> | |
| Scene active | Checkbox (yes / no) |
| <p>With a fixed scene configuration, individual scenes can be activated or deactivated. Only activated scenes can be used. A deactivated scene cannot be recalled or stored via the scene extension unit.</p> <p>This parameter is only available with fixed scene configuration.</p> | |
| Brightness value | switch off Basic brightness 5 % ... 100 % |
| <p>This parameter is used for configuring the value which is set when the scene is recalled.</p> | |

| Memory function | Checkbox (yes / no) |
|---|---------------------|
| <p>If the parameter is activated, the storage function of the scene is enabled. The current switching state can then be stored internally via the extension object on receipt of a storage telegram. If the parameter is deactivated, the storage telegrams are rejected.</p> | |

10.15.2 Object list scene function

| Object no. | Function | Name | Type | DPT | Flag |
|--|----------------------|----------------------|--------|--------|-----------------|
| 38, 58, 78, 98 | Scene extension unit | Switching... - Input | 1-byte | 18,001 | C, (R), W, -, A |
| 1-byte object for calling or saving a scene. | | | | | |

| Object no. | Function | Name | Type | DPT | Flag |
|---|-----------------------|----------------------|-------|-------|-----------------|
| 37, 57, 77, 97 | Extended scene recall | Switching... - Input | 1-bit | 1,001 | C, (R), W, -, A |
| 1-bit object for extended scene recall. Each ON telegram received recalls the next scene of a dimming channel in sequence. Each OFF telegram received recalls the previous scene. After a reset (bus voltage return, ETS programming operation), an ON or OFF telegram always recalls scene 1 first. | | | | | |

10.16 Staircase function

The staircase function can be used for implementing time-controlled lighting of a staircase or for function-related applications. The staircase function must be enabled in the ETS on the parameter page "Dimming channel ... -> DO... - General -> Enabled functions", in order for the required communication objects and parameters to be switched to visible.

The staircase function is activated via the communication object "Staircase function start / stop" and is independent of the "Switching" object of a dimming channel. In this way, parallel operation of time and normal control is possible, whereby the command last received is always executed: A telegram to the "Switching" object or a scene recall at the time of an active staircase function aborts the staircase time prematurely and presets the switching state according to the received object value (the time delays are also taken into account) or scene value. Likewise, the switching state of the "Switching" object can be overridden by a staircase function.

Time-independent continuous light switching can also be implemented in combination with a disabling function because the disabling function has a higher priority and overrides the switching state of the staircase function.

The staircase function can also be extended by means of a supplementary function. At the same time, it is possible to activate a time extension. The "Time extension" permits retriggering of an activated staircase via the object "Staircase function Start / Stop" n-times. Alternatively, the "Time preset via the bus" can be set. With this supplementary function, the configured staircase time can be multiplied by a factor received via the bus, thus it can be adapted dynamically.

Furthermore, an extension of the staircase function can be implemented by means of a separate switch-on delay and pre-warning function. The pre-warning should, according to DIN 18015-2, warn any person still on the staircase that the light will soon be switched off. As an alternative to the pre-warning at the end of the staircase time, the actuator can activate reduced continuous lighting. In this way, for example, long, dark hallways can have permanent basic lighting.

Specifying switch-on behaviour of the staircase function

An ON telegram to the "Staircase function start/stop" object activates the staircase time (T_{ON}), the duration of which is defined by the parameters "Staircase time". In addition, a switch-on delay (T_{Delay}) can be activated (see "Presetting switch-on delay of the staircase function"). At the end of the staircase time, the output switches off or activates optionally the pre-warning time ($T_{Prewarn}$) of the pre-warning function (see "Presetting pre-warning function of the staircase function"). Taking into account any possible switch-on delay and pre-warning function, this gives rise to the switch-on behaviour of the staircase function as shown in the following diagram.

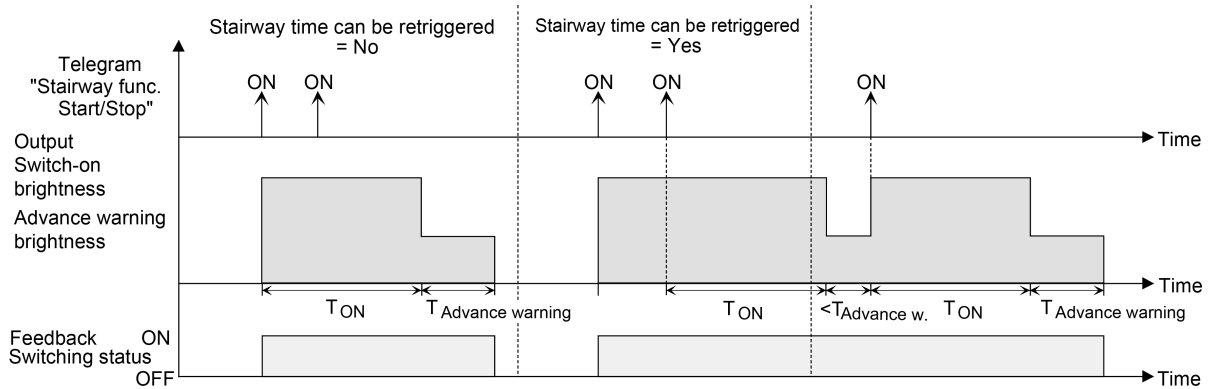

Figure 16: Switch-on behaviour of the staircase function without soft functions

In addition, switching on can be influenced by the soft functions of the actuator. Taking into account any soft ON and soft OFF function, this gives rise to a modified switch-on behaviour of the staircase function

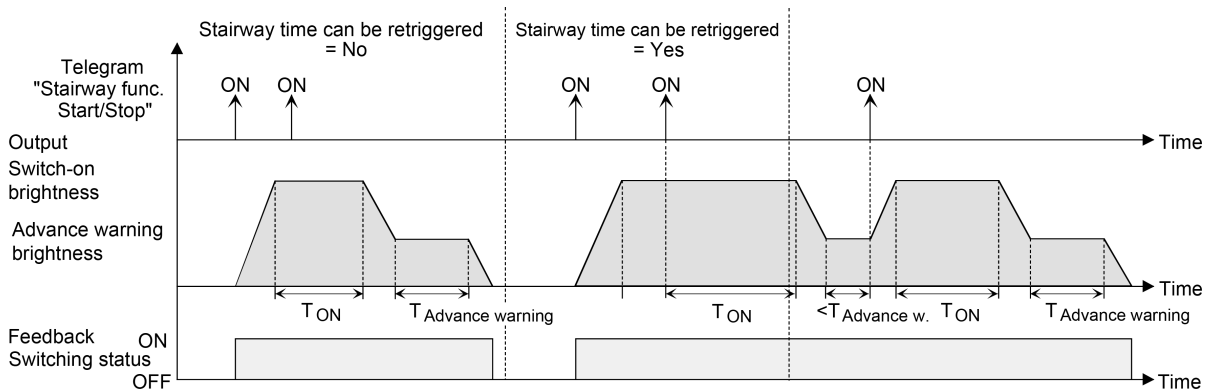

Figure 17: Switch-on behaviour of the staircase function with soft functions (as an example with minimum brightness = 0 %)

The parameter "Staircase time retrIGGERABLE" specifies whether the staircase time can be retrIGGERED.

Prerequisite:

The staircase function must be enabled on the parameter page "Dimming channel ... -> DO... - General -> Enabled functions".

- In the parameter "Staircase time" on the parameter page "Dimming channel ... -> DO... - General -> Staircase function", configure the required switch-on time of the staircase function.
- Activate parameter "Staircase time retrIGGERABLE".

Every ON telegram received during the ON phase of the staircase time retriggers the staircase time completely.

- Deactivate parameter "Staircase time retrIGGERABLE".

ON telegrams received during the pre-warning time are rejected. The staircase time is not retrIGGERED.

- i** An ON telegram received during the pre-warning time always retriggers the staircase time independently of the parameter "Staircase time retrIGGERABLE".

- i** When the supplementary function "Time extension" is preset, the parameter "Staircase time retriggerable" cannot be adjusted. In this case, it is permanently deactivated.

Specifying switch-off behaviour of the staircase function

In the case of a staircase function, the reaction to an OFF telegram can also be configured on the object "Staircase function start/stop". At the end of the staircase time, a dimming channel always shows the reaction "At the end of the staircase time" configured in the ETS, without the receipt of an OFF telegram. At the same time, the channel can switch off, optionally activate the pre-warning time (TVorwarn) of the pre-warning function or dim to the reduced continuous lighting (application: e.g. long, dark hallways). If, on the other hand, the dimming channel receives an OFF telegram via the object "Staircase function start/stop", the actuator evaluates the parameter "Reaction to an OFF-telegram". In this case, the channel can react immediately to the OFF telegram and end the staircase time prematurely. Alternatively, the OFF telegram can be ignored. Taking into account any possible pre-warning function, this gives rise to the example switch-off behaviour of the staircase function.

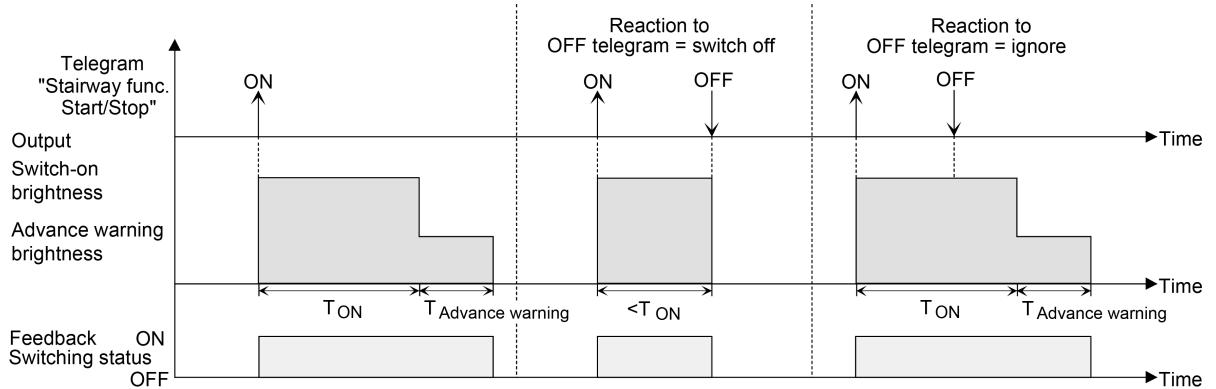

Figure 18: Switch-off behaviour of the staircase function without soft functions

In addition, the switch-off can be influenced by the soft functions of the actuator. Taking into account any soft ON and soft OFF function, this gives rise to a modified switch-off behaviour of the staircase function.

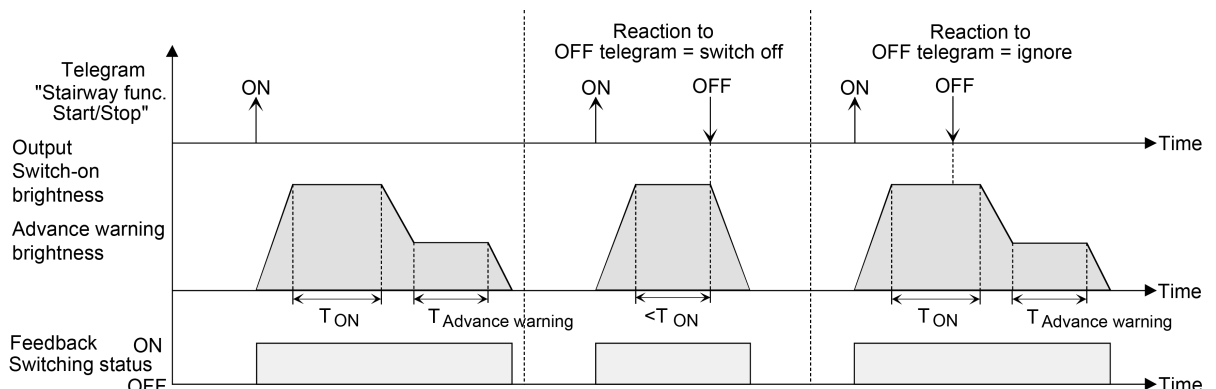

Figure 19: Switch-off behaviour of the staircase function with soft functions (as an example with minimum brightness = 0 %)

The parameter "Reaction to OFF-telegram" defines whether the staircase time (T_{ON}) of the staircase function can be aborted prematurely.

Prerequisite:

The staircase function must be enabled on the parameter page "Dimming channel ... -> DO... - General -> Enabled functions".

- Set parameter "Reaction to OFF-telegram" to "switch off".

As soon as an OFF telegram is received via the object "Staircase function start/stop" during the ON phase of the staircase time, the output switches off immediately. If the staircase time is stopped prematurely by such a telegram, there is no pre-warning, i.e. the pre-warning time is not started. There is also no dimming to a reduced continuous lighting. It is also possible to switch off prematurely during a dimming procedure of a soft function or during a pre-warning or reduced continuous lighting.

- Set parameter "Reaction to OFF-telegram" to ignore".

OFF telegrams received during the ON phase of the staircase time are rejected. The staircase time will be executed completely to the end with pre-warning if necessary.

i With the supplementary function "Time preset via the bus", the staircase time of the staircase function can also be started by the reception of a new time factor. In this case, received "0" factors are interpreted as an OFF telegram. Here too, the parameter "Reaction to OFF telegram" is evaluated so that a staircase time can be cancelled early.

i The parameter "Reaction to OFF telegram" does not influence the reception and the evaluation of OFF telegrams via the "Switching" object.

Setting the switch-on delay of the staircase function

An ON telegram for activation of the staircase function can also be evaluated with a time delay. This switch-on delay can be activated separately for the staircase function and has no influence on the configurable time delays for the object "Switching".

Prerequisite:

The staircase function must be enabled on the parameter page "Dimming channel ... -> DO... - General -> Enabled functions".

- On the parameter page "Dimming channel ... -> DO... - General -> Staircase function", deactivate the "Switch-on delay" parameter.

The switch-on delay is deactivated. After reception of an ON telegram on the object "Staircase function start/stop", the staircase time is activated immediately and the output switched on.

- Activate the parameter "Switch-on delay".

The switch-on delay for the staircase function is enabled. The desired switch-on delay time can be specified. After receipt of an ON telegram on the object "Staircase function start/stop", the switch-on delay is started. Another ON-telegram triggers the time only when the parameter "Switch-on delay retriggerable" is activated. The staircase time is activated and the output is switched on only after the time delay has elapsed.

- i** An OFF telegram via the object "Staircase function start/stop" during the switch-on delay only terminates the delay if the parameter "Reaction to OFF-telegram" is set to "Switch off". Otherwise, the OFF telegram is ignored.
- i** When the supplementary function "Time extension" is preset, the parameter "Switch-on delay retriggerable" cannot be adjusted. In this case, it is permanently deactivated.

Setting the pre-warning function of the staircase function

At the end of the switch-on time of the staircase function, the actuator for the dimming channel concerned shows the reaction "At the end of the staircase time" configured in the ETS. The channel can be set to switch off immediately, alternatively to dim to the reduced continuous lighting (application: e. g. long, dark hallways) or to execute the pre-warning function. If the parameter is configured to "Activate pre-warning time", the pre-warning time ($T_{Vorwarn}$) and pre-warning brightness can be configured in the ETS.

The pre-warning should, according to DIN 18015-2, warn persons still on the staircase that the light will soon be switched off. As a pre-warning, a dimming channel can be set to a pre-warning brightness before the channel switches off permanently. The pre-warning brightness is normally reduced in the brightness value compared to the switch-on brightness. The pre-warning time is added to the staircase time (T_{ON}). The pre-warning time influences the value of the feedback object so that the value "OFF" (in the case of non-inverted transmission) is first tracked after the pre-warning time in the object has elapsed.

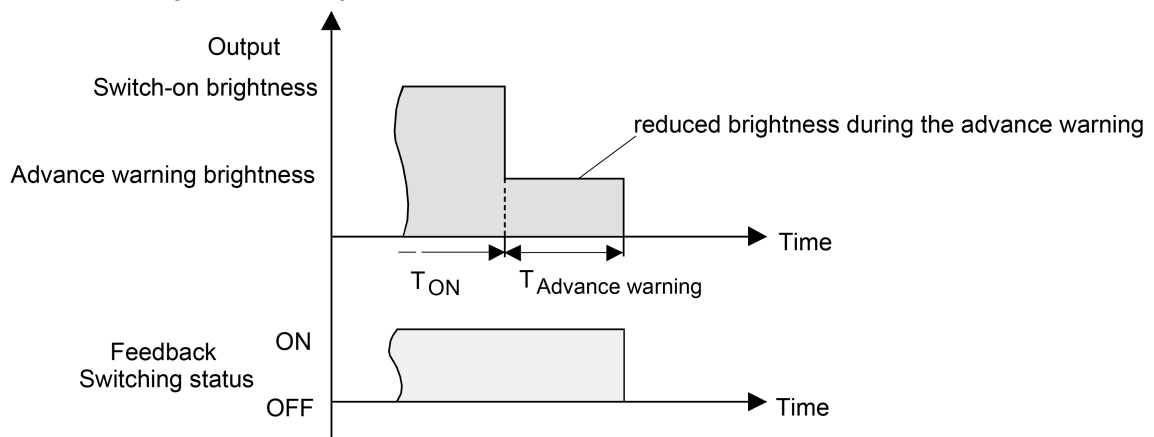

Figure 20: The pre-warning function of the staircase function without soft OFF function

Additionally, the pre-warning function can also be extended by the soft OFF function. Taking into account any soft OFF function, this gives rise to a modified switch-off behaviour of the staircase function after the pre-warning has elapsed.

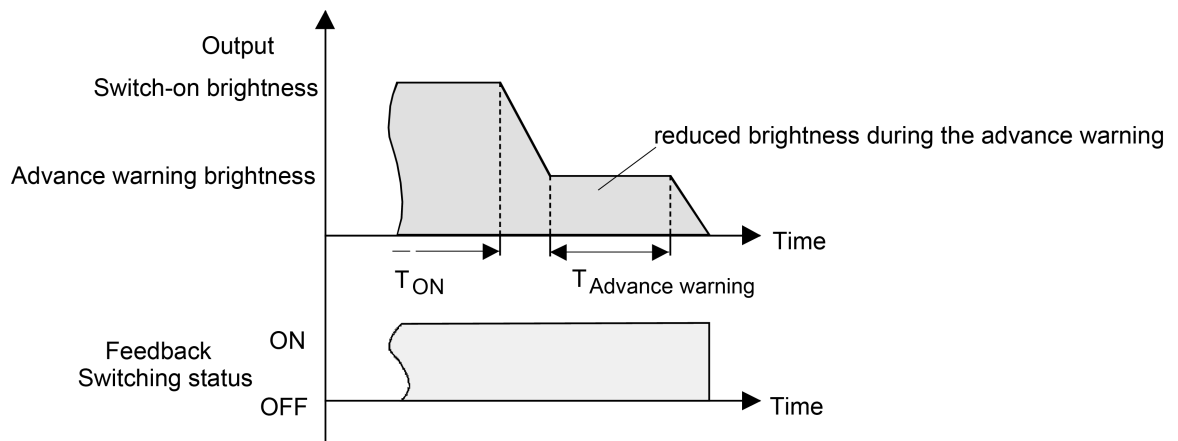

Figure 21: The pre-warning function of the staircase function with soft OFF function (as an example with minimum brightness = 0%)

Prerequisite:

The staircase function must be enabled on the parameter page "Dimming channel ... -> DO... - General -> Enabled functions".

- On the parameter page "Dimming channel ... -> DO... - General -> Staircase function", set the parameter "At the end of the staircase time" to "Activate pre-warning time".

The pre-warning function is enabled. The desired pre-warning time ($T_{Prewarn}$) can be preset.

- Set the parameter "Reduced brightness" to the desired value.

During the pre-warning time, the dimming channel is set to the configured brightness value.

- i** The configured value for the reduced brightness must be greater than or equal to the minimum brightness (if configured) or less than or equal to the maximum brightness!
- i** An ON telegram to the object "Staircase function start/stop" while a pre-warning function is still in progress stops the pre-warning time and always restarts the staircase time (independently of the parameter "Staircase time retriggerable"). Even during the pre-warning time, the parameter "Reaction to OFF telegram" is evaluated so that a pre-warning in progress can be terminated early by switching off.
- i** An ON telegram to the object "Staircase function start/stop" while a pre-warning function is still in progress stops the pre-warning time and always starts (independently of the parameter "Staircase time retriggerable ?") the staircase time anew. Even during the pre-warning time, the parameter "Reaction to OFF telegram" is evaluated so that a pre-warning in progress can be terminated early by switching off.
- i** Using the automatic switch-off function: The reduced brightness of the pre-warning does not start the switch-off function after reaching or undershooting the switch-off brightness!

Setting continuous lighting of the staircase function

At the end of the switch-on time of the staircase function, the actuator for the dimming channel concerned shows the "Reaction at the end of the staircase time" configured in the ETS. The channel can be set to switch off immediately, alternatively to execute a pre-warning function, or to dim to reduced continuous lighting. The reduction of the lighting to continuous lighting after the staircase time has elapsed is appropriate, for example, if a certain degree of artificial light should be switched on permanently in long, dark hallways. Switching to switch-on brightness by activating the staircase function normally takes place by additional presence detectors or monitors when people are present in the hallway.

If the parameter "Reaction at the end of the staircase time" is configured to "Activate reduced continuous lighting", the brightness for the continuous lighting can be configured in the ETS. The continuous brightness is normally reduced in the brightness value compared to the switch-on brightness.

The continuous lighting remains permanently active after the staircase time has elapsed. Only when an ON telegram is received again via the object "Staircase function start/stop" does the actuator switch back to the switch-on brightness and start counting the staircase time again. The receipt of an OFF telegram via the object "Staircase function start/stop" only switches the continuous lighting off if the parameter "Reaction to OFF-telegram" is configured to "Switch off".

- i** A dimming channel can always be switched on and off via the "Switching" object independently of the staircase function. Consequently, continuous lighting will also be overridden if telegrams arrive on the actuator via the "Switching" object. If permanent continuous lighting is desired, which cannot be influenced by the "Switching" object nor by the object of the staircase function, the disabling function of the actuator should be used.

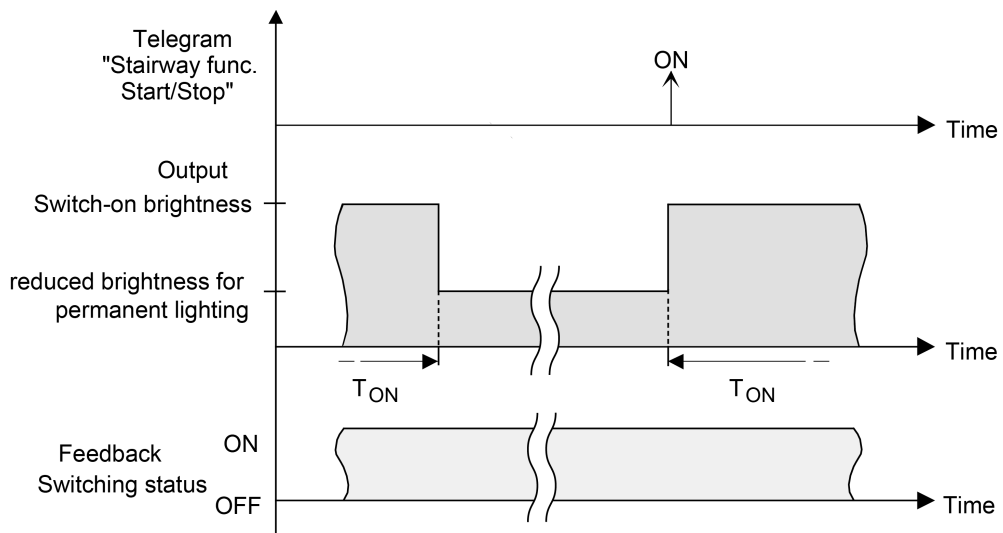

Figure 22: The continuous lighting of the staircase function without soft functions

Additionally, the continuous lighting can also be extended by the soft function. Taking into account any soft ON and soft OFF function, this gives rise to modified continuous lighting behaviour of the staircase function.

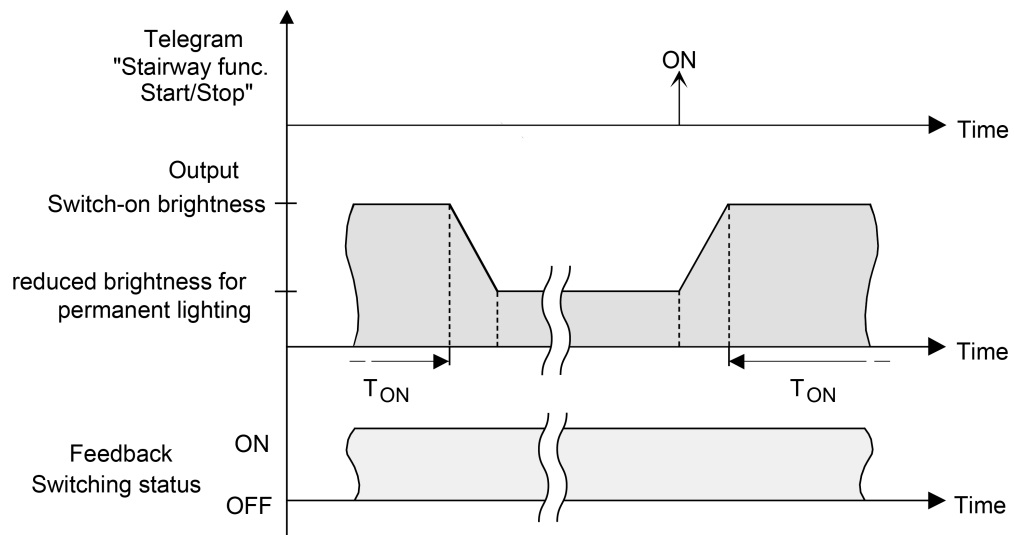

Figure 23: The continuous lighting of the staircase function with soft OFF functions

- i** The brightness of the continuous lighting does not necessarily have to be less than the switch-on brightness. The brightness of the continuous lighting can always be configured to values between basic/minimum brightness and maximum brightness.

Prerequisite:

The staircase function must be enabled on the parameter page "Dimming channel ... -> DO... - General -> Enabled functions".

- On the parameter page "Dimming channel ... -> DO... - General -> Staircase function", set the parameter "At end of the staircase time" to "Activate reduced continuous lighting".

The continuous lighting is enabled. The "Reduced brightness" can be set to the desired brightness value.

- i** The configured value for the reduced brightness must be greater than or equal to the minimum brightness (if configured) or less than or equal to the maximum brightness!
- i** An ON telegram to the object "Staircase function start/stop" while a pre-warning function is still in progress stops the pre-warning time and always restarts the staircase time (independently of the parameter "Staircase time retriggerable"). Even during activated continuous lighting, the parameter "Reaction to OFF telegram" is evaluated so that continuous lighting can be switched off.
- i** Using the automatic switch-off function: The reduced brightness of the continuous lighting does not start the switch-off function after reaching or undershooting the switch-off brightness!

Setting supplementary function of the staircase function – time extension

With the time extension function, the staircase time can be retriggered several times (i.e. extended) via the "Staircase function start/stop" object. The duration of the extension is predefined by several operations at the control section (several ON tele-

grams in succession). The configured staircase time can be extended in this way by the configured factor (a maximum of 5-fold). The time is then always extended automatically at the end of a single staircase time (T_{ON}).

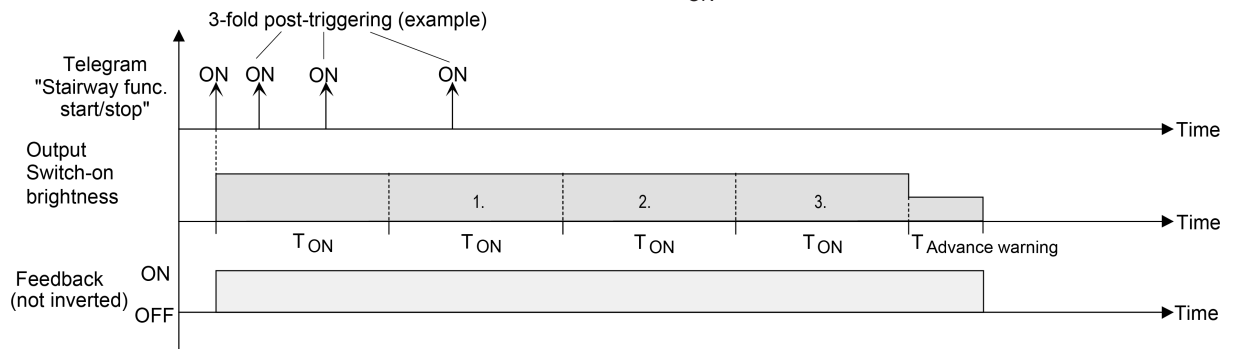

Figure 24: Time extension of the staircase function

With this function, the lighting time in a staircase can be extended (e. g. by a person after shopping) by a defined length without having to retrigger the lighting every time the lighting shuts off automatically.

Prerequisite:

The staircase function must be enabled on the parameter page "Dimming channel ... -> DO... - General -> Enabled functions".

- On the parameter page "Dimming channel ... -> DO... - General -> Staircase function" Set the parameter "Supplementary function for staircase function" to "Time extension" and set the maximum desired factor on the parameter "Maximum time extension".

The staircase time is retriggered each time an ON telegram is received on the "Staircase time start/stop" object after the staircase time has elapsed, depending on the number of telegrams received, but only as often as pre-defined by the configured factor.

For example, the "3-fold time" setting means that after the started staircase time has elapsed, it can be retriggered automatically a maximum of three additional times. The time is therefore extended a maximum of four fold.

- i** A time extension can be triggered during the entire staircase time (T_{ON}). There is no time limit between two telegrams for the time extension. Telegrams for the time extension are only evaluated during the staircase time. An ON telegram during the pre-warning function triggers the staircase time as a restart, which means that a new time extension is possible. If a switch-on delay was configured, the time extension is recorded during the switch-on delay.

- i** If a time extension was configured as a supplementary function, the parameters "Staircase time retriggerable" and "Switch-on delay retriggerable" are permanently deactivated since the staircase time can be retriggered by the time extension.

Setting supplementary function of the staircase function – time preset via the bus

With time specification via the bus, the configured staircase time can be multiplied by an 8-bit factor received via the KNX, thus it can be adapted dynamically. With this setting, the factor is derived from the object "Staircase time factor". The possible factor value for setting the staircase time is between 1...255.

The entire staircase time arises as a product from factor (object value) and the configured staircase time as a basis as follows...

Staircase time = (staircase time object value) x (staircase time parameter)

Example:

Object value "Staircase time factor" = 5; parameter "Staircase value" = 10s.
-> set staircase time = 5 x 10s = 50 s.

Alternatively, the staircase function parameter can define whether the receipt of a new factor also starts the staircase time of the staircase function at the same time. In this case, the object "Staircase function start/stop" is not necessary and the received factor value determines the starting and stopping.

Prerequisite:

The staircase function must be enabled on the parameter page "Dimming channel ... -> DO... - General -> Enabled functions".

- On the parameter page "Dimming channel ... -> DO... - General -> Staircase function", set the "Supplementary function" parameter to "Time preset via bus" and deactivate the parameter "Staircase function activatable via 'Staircase time' object".

The staircase time can be adapted dynamically by the "Staircase time factor" object. A value "0" is interpreted as value "1". The staircase function is started and stopped exclusively via the "Staircase function start / stop" object.

- Activate the parameter "Supplementary function" to "Time preset via the bus" and activate the parameter "Staircase function activatable via 'Staircase time' object".

The staircase time can be adapted dynamically by the "Staircase time factor" object. In addition, the staircase function is started with the new staircase time (the object "Staircase function start / stop" is not necessary). A factor value "0" is interpreted as an OFF telegram, whereby in this case, the configured reaction to an OFF telegram is evaluated, too.

A larger staircase with several floors is an example as an application for the time preset via the bus with automatic starting of the staircase time. On each floor there is a push-button sensor that transmits a factor value to the staircase function. The higher the floor, the greater the factor value transmitted so that the lighting stays switched on longer if the passing through the staircase needs more time. When a person enters a staircase and a pushbutton is pressed, the staircase time is now adjusted dynamically to the staircase time and switches on the lighting at the same time, too.

- i** The staircase function is started via the reception of a new factor: A factor > 0 received during a pre-warning time always triggers the staircase time independently of the parameter "Staircase time retriggerable".
- i** After a reset (bus voltage return or ETS programming) the "Staircase time factor" object is always initialised with "1". However, the staircase function is not started automatically solely as the result of this (see "Set behaviour of staircase function after bus voltage returns").
- i** The two supplementary functions "Time extension" and "Time preset via the bus" can only be configured alternatively.

Setting the behaviour of the staircase function after the bus voltage returns

The staircase function can optionally be started automatically after the bus voltage returns.

Prerequisite:

The staircase function must be enabled on the parameter page "Dimming channel ... -> DO... - General -> Enabled functions".

- On the parameter page "Dimming channel ... -> DO... - General", set the parameter "After bus voltage returns" to "Activate staircase function".

The staircase time of the staircase function is started immediately after the bus voltage returns.

- i** When automatically starting the staircase function after the bus voltage returns, no switch-on delay is started if the staircase function has configured such a delay.
- i** The device only executes the configured "Behaviour on bus voltage return" only if the last ETS programming of the application or of the parameters ended at least approx. 20 s prior to switching on the bus voltage. Otherwise ($T_{ETS} < 20$ s) the behaviour "After ETS programming" will be adopted also in case of bus voltage return.
- i** The configured behaviour will be executed only if no forced position after the bus voltage returns has been activated.

10.16.1 Staircase function parameters

Dimming channel ... -> DO... - General -> Enabled functions

| | |
|--|---|
| Staircase function/logic operation function | no selection Staircase function Logic operation function |
| This parameter determines whether the staircase function or alternatively the logic operation function is available for the dimming channel. | |

Dimming channel ... -> DO... - General -> Staircase function

| | |
|---|----------------------------------|
| Staircase time | 0...23 h 0...3...59 0...59 |
| The duration of the switch-on time for the staircase function is configured here. | |

| | |
|---|---------------------|
| Staircase time retriggerable | Checkbox (yes / no) |
| An active switch-on time can be retriggered (parameter activated). Alternatively, the retriggering time (parameter deactivated) can be suppressed. This parameter is preset to deactivated if the supplementary function "Time extension" is configured. Re-triggering will not be possible. | |

| | |
|---|---------------------|
| Switch-on delay | Checkbox (yes / no) |
| The staircase function enables the activation of an own switch-on delay. This switch-on delay affects the trigger result of the staircase function and thus delays the switch-on. activated: The switch-on delay for the staircase function is enabled. After receipt of an ON telegram on the object "Staircase function start/stop", the switch-on delay is started. Another ON-telegram triggers the time only when the parameter "Switch-on delay retriggerable" is activated. The staircase time is activated and the output is switched on only after the time delay has elapsed. deactivated: The switch-on delay is deactivated. After receipt of an ON telegram on the object "Staircase function start/stop", the staircase time is activated immediately and the output switched on. | |

| | |
|---|-----------------------------------|
| Switch-on delay | 0...23 h 0...59 0...30...59 |
| This parameter is used for setting the duration of the switch-on delay. | |

| | |
|--|---|
| Switch-on delay retriggerable | Checkbox (yes / no) |
| <p>An active switch-on delay can be retriggered (parameter activated). Alternatively, the retriggering time (parameter deactivated) can be suppressed.</p> <p>This parameter is deactivated if the supplementary function "Time extension" is configured. Re-triggering will not be possible.</p> <p>The parameters for the switch-on delay are only visible when the switch-on delay is used.</p> | |
| Reaction to OFF-telegram | switch off ignore |
| <p>An active switch-on time can be aborted prematurely by switching off the staircase function.</p> <p>switch off: The switch-on time is aborted after receipt of an OFF telegram on the object "Staircase time start/stop".</p> <p>With the supplementary function "time preset via the bus" and the setting "Staircase function activatable via object 'Staircase time' = activated" the switch-on time can also be prematurely ended by a factor of "0".</p> <p>ignore: OFF Telegrams or "0" factors are ignored. The switch-on time will be executed completely to the end.</p> | |
| Supplementary function | no supplementary function Time extension Time preset via the bus |
| <p>The staircase function can be extended by the two supplementary functions "Time extension" and "Time specifications via bus", which should be used alternatively. This parameter enables the desired supplementary function and thereby activates the necessary parameters or objects.</p> <p>no supplementary function: No supplementary function is enabled.</p> <p>Time extension: The time extension is activated. This function permits retriggering an activated staircase lighting time span n-times via the object "Staircase function start/stop".</p> <p>Time preset via the bus: The time preset via the bus is activated. With this supplementary function, the configured switch-on time can be multiplied by a factor received via the KNX, thus it can be adapted dynamically.</p> | |

| | |
|---|--|
| Maximum time extension | 1-fold staircase time 2-fold staircase time 3-fold staircase time 4-fold staircase time 5-fold staircase time |
| <p>In case of a time extension (retriggering the lighting time n-times via the object "Staircase function start/stop"), the parameterized staircase lighting time will be extended by the value programmed in this parameter.</p> <p>"1-fold staircase time" means that after the started staircase time has elapsed, it can be retriggered a maximum of one more time. The time is therefore extended two fold. The other settings behave in a similar manner.</p> <p>This parameter is visible only if the supplementary function "Time extension" is set.</p> | |
| Staircase function activatable via "Staircase time" object | Checkbox (yes / no) |
| <p>A time preset via the bus can specify here whether the receipt of a new time factor also starts the switch-on time (parameter activated). At the same time, the object "Staircase function start/stop" is hidden.</p> <p>If the parameter is deactivated, the switch-on time can be activated exclusively via the object "Staircase function start/stop".</p> <p>This parameter is visible only if the supplementary function "time preset via the bus" is set.</p> | |
| At the end of staircase time | switch off Activate pre-warning time activate reduced continuous lighting |
| <p>At the end of the staircase time, the actuator for the dimming channel concerned displays the configured behaviour here. The output can be set to switch off immediately or alternatively to execute a pre-warning function.</p> <p>switch off: At the end of the staircase time, the actuator switches off the dimming channel concerned.</p> <p>Activate pre-warning time: At the end of the staircase time, the dimming channel can generate a pre-warning prior to switch-off. The pre-warning, for example, should warn any person still on the staircase that the light will soon be switched off.</p> <p>Activate reduced continuous lighting: At the end of the switch-on time, the actuator activates reduced continuous lighting for the dimming channel concerned. The reduction of the lighting to continuous lighting is appropriate, for example, if a certain degree of artificial light should be switched on permanently in long, dark hallways. Switching to switch-on brightness by activating the staircase function normally takes place by additional presence detectors or monitors when people are present in the hallway. The continuous lighting remains permanently active after the switch-on time has elapsed. Only when an ON telegram is received again via the object "Staircase function start/stop" does the actuator switch back to the switch-on brightness and start counting the switch-on time again.</p> | |

| | |
|---|---|
| Pre-warning time | 0...59 min 0... 30 ...59 s |
| This parameter is used for setting the duration of the pre-warning time. The pre-warning time is added to the switch-on time. | |
| Reduced brightness | Basic brightness 5 % ... 50 % ... 100 % |
| This parameter defines the reduced brightness that is set either for pre-warning or continuous lighting. | |

10.16.2 Object list staircase function

| Object no. | Function | Name | Type | DPT | Flag |
|---|-------------------------------|----------------------|--------|-------|-----------------|
| 41, 61, 81, 101 | Staircase function start/stop | Switching... - Input | 1-bit | 1,010 | C, (R), W, -, A |
| 1-bit object to activate or deactivate the switch-on time of the staircase function of a dimming output ("1" = switch-on / "0" = switch-off). | | | | | |
| Object no. | Function | Name | Type | DPT | Flag |
| 42, 62, 82, 102 | Staircase time factor | Switching... - Input | 1-byte | 5,010 | C, (R), W, -, A |
| 1-byte object to specify a time factor for the switch-on time of the staircase function (value range: 0... 255). | | | | | |

10.17 Logic operation function

A logic function can be parameterized separately for each dimming channel. This function allows the logic operation of the "Switching" object state and an additional logic operation object. The state of the communication object for "Switching" can also be evaluated with a time delay if a switch-on delay or switch-off delay is set. The logic operation function can also be combined with other functions of a dimming channel. A combination with the staircase function is not possible, however.

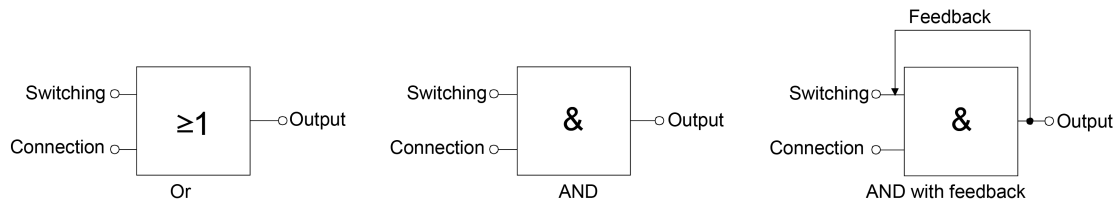

Figure 25: Logic operation types of the logic operation function

- i** "AND with feedback":
 With a logic object = "0", the switching output is always "0" (logic AND). In this case, the feedback signal from the output to the "Switching" input will directly reset this input when it is being set. The output of the switching output can assume the logical state "1" by a newly received "1" on the input "Switching" only when the logic object is = "1".

The object "Logic operation" can be initialised with a configured value after the bus voltage returns or after an ETS programming operation so that a correct logic operation result can be determined immediately and set on the output during a telegram update on the "Switching" object.

- On the parameter page "Dimming channel ... -> DO... - General -> Enabled functions", activate the "Logic operation function" parameter.
- The logic operation function is enabled. The communication object "Logic operation" and the parameters of the logic operation function on the parameter page "Dimming channel ... -> DO... - General -> Logic operation function" become visible.
- Set the parameter "Type of logic operation function" to the desired logic operation type.
 - Set the parameters "Object value after bus voltage returns" and "Object value after ETS programming" to the required initial states.

The "Logic operation" object is initialised immediately with the set switching states after bus voltage return or ETS programming of the application program or parameters.

- i** The logic operation function after a reset of the actuator (bus voltage return or ETS programming operation) is first executed when the switching object is updated as the input of the logic operation by at least one telegram.
- i** The states or switching states specified at the end of a disabling function or forced position function, which are set after programming in the ETS, in the case of bus voltage failure or after the bus voltage returns, override the logic

operation function. The configured logic operation is first re-executed and the result set on the switching output when the switching object is updated as the input of the logic operation by at least one telegram.

10.17.1 Logic operation function parameters

Dimming channel ... -> DO... - General -> Enabled functions

| | |
|--|---|
| Staircase function/logic operation function | no selection Staircase function Logic operation function |
| This parameter determines whether the staircase function or alternatively the logic operation function is available for the dimming channel. | |

Dimming channel ... -> DO... - General -> Logic operation function

| | |
|---|---|
| Type of logic operation function | OR AND AND with feedback |
| This parameter defines the logical type of the logic operation function. The object "Logic operation" is linked to the logic switching state of the dimming channel (object "Switching" after evaluation of configured time delays if necessary) using the logic operation function set here. This parameter is only visible when the logic operation function is enabled. | |

| | |
|--|---------------------------------|
| Object value after bus voltage returns | 0 (OFF) 1 (ON) |
| After the bus voltage returns, the object value of the logic operation object is initialised here with the preset value. This parameter is only visible when the logic operation function is enabled. | |

| | |
|---|---------------------------------|
| Object value after ETS download | 0 (OFF) 1 (ON) |
| After programming the application or the parameters in the ETS, the object value of the logic operation object is initialised here with the preset value. This parameter is only visible when the logic operation function is enabled. | |

10.17.2 Object list logic operation function

| Object no. | Function | Name | Type | DPT | Flag |
|---|-----------------|----------------------|-------|-------|-----------------|
| 33, 53, 73, 93 | Logic operation | Switching... - Input | 1-bit | 1,002 | C, (R), W, -, A |
| 1-bit object for the input of the logical operation of a dimming channel. After the bus voltage returns or after programming with the ETS, the object value can be pre-defined by means of a parameter. | | | | | |

10.18 Operating hours counter

The operating hours counter determines the switch-on time of a dimming channel. A channel is actively on for the operating hours counter if the brightness value is greater than "0", i.e. when current is flowing to the load.

The operating hours counter can either be configured as a second counter or as an hour counter.

- Second counter

The actuator adds up the determined switch-on time accurately to the second for a switched-on dimming channel. The totalled operating seconds are added in a 4-byte counter and stored permanently in the device. The current counter reading can be transmitted cyclically to the KNX by the "Operating hours counter - Counter reading - Status" communication object or when there is a change in an interval value in accordance with DPT 13.100.

- Hour counter

The actuator adds up the determined switch-on time accurately to the minute for a switched-on dimming channel in full operating hours. The totalled operating hours are added in a 2-byte counter and stored permanently in the device. The current meter reading can be transmitted cyclically to the KNX by the "Operating hours counter - Counter reading - Status" communication object or when there is a change in an interval value in accordance with DPT 7.007.

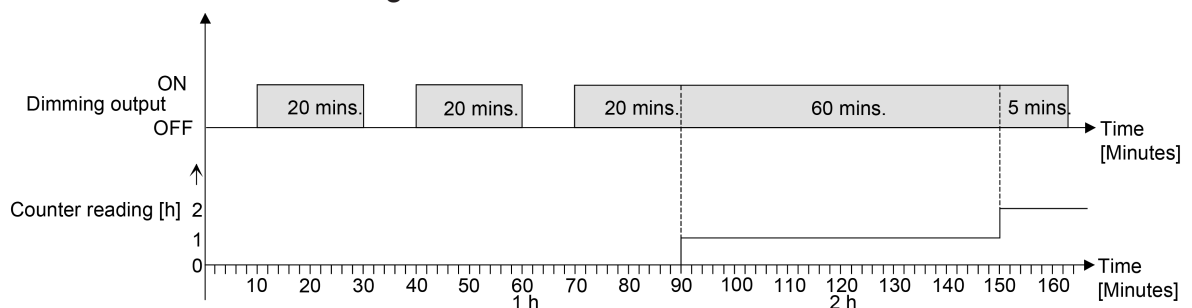

Figure 26: Function of the operating hours counter (using the example of counted hours)

In the delivery state, all values of the actuator are "0". If the operating hours counter is not enabled in the configuration of an output, no operating hours or operating seconds will be counted for the output concerned. Once the operating hours counter is enabled in the ETS, however, the operating hours or operating seconds will be determined and added up by the ETS immediately after commissioning the actuator. If the operating hours counter is subsequently disabled again in the parameters and the actuator is programmed with this disabling function, all the operating hours or operating seconds previously counted for the output concerned will be deleted. When enabled again, the meter reading of the operating hours counter is always set to "0".

The operating hours values (full hours) or operating seconds stored in the device will not be lost in case of a bus voltage failure or by ETS programming.

On the hour counter: Any summed up operating minutes (full hour not yet reached) will be rejected in this case, however.

After the bus voltage returns or after an ETS programming operation, the actuator passively updates the "Operating hours counter - Counter reading - Status" communication object for each output. The object value can be read out if the read-flag is

set. The object value, depending on the configuration for the automatic transmission, is actively transmitted if necessary to the KNX once the configured transmission delay has elapsed after the bus voltage returns (see "Set transmission behaviour of the operating hours counter").

Activating the operating hours counter

- On the parameter page "Dimming channel ... -> DO... - General -> Enabled functions", activate the "Operating hours counter" parameter.

The operating hours counter is activated.

- Deactivate the "Operating hours counter".

The operating hours counter is deactivated.

- i** Disabling of the operating hours counter and subsequent programming with the ETS resets the counter status to "0".

Setting the counter type

The operating hours counter can optionally be configured as an up-counter or down-counter. Depending on this type of counter, a limit or start value can be set optionally, whereby, for example, the operating time of a lamp can be monitored by restricting the counter range.

Up-counter:

After activating the operating hours counter by enabling in the ETS or by restarting, the operating hours are counted starting at "0". A maximum of 65,535 hours or 2,147,483,647 can be counted (corresponds to approx. 66 years), after that the counter stops and signals a counter operation via the "Operating hours counter elapsed" object.

A limiting value can be set optionally in the ETS or can be predefined via the communication object "Limiting value operating hours counter". In this case, the counter operation is signaled to the KNX via the "Operating hours counter elapsed" object if the limiting value is reached, but the counter continues counting - if it is not restarted - up to the maximum value and then stops. Only a restart initiates a new counting operation.

Down-counter:

After enabling the operating hours counter in the ETS, the meter reading is on "0" and the actuator signals a counter operation for the output concerned after the programming operation or after the bus voltage returns by means of the "Operating hours counter elapsed" object. Only after a restart is the down-counter set to the maximum value of 65,535 hours or 2,147,483,647 seconds (corresponds to approx. 66 years) and the counter operation is started.

A start value can be set optionally in the ETS or can be predefined via the communication object "start value operating hours counter". If a start value is set, the down-counter is initialised with this value instead of the maximum value after a restart. The counter then counts the start value downwards by the hour. When the down-counter

reaches the value "0", the counter operation is signalled to the KNX via the "Operating hours counter elapsed" and the counting is stopped. Only a restart initiates a new counting operation.

The operating hours counter must be enabled on the parameter page "Dimming channel ... -> DO... - General -> Enabled functions".

- Set the parameter "Counter type" on the parameter page "Dimming channel ... -> DO... - General -> Operating hours counter" to "Up counter". Set the parameter "Limiting value presetting" to "Yes, as specified in parameter" or "Yes as received via object" if it is necessary to monitor the limiting value. Otherwise, reset the parameter to "No". In the "Yes, as specified in parameter" setting, specify the required limit value.

The counter counts the operating hours forwards starting from "0". If the monitoring of the limiting value is activated, the actuator transmits an "ON"-telegram via the object "Operating hours counter elapsed" for the output concerned once the predefined limiting value is reached. Otherwise, the counter operation is first transmitted when the maximum value is reached.

- Set the parameter "Counter type" to "Down-counter". Set the parameter "Start value preset" to "Yes, as parameter" or "Yes, as received via object" if a start value preset is necessary. Otherwise, reset the parameter to "No". In the "Yes, as specified in parameter" setting, specify the required start value.

The counter counts the operating hours down to "0" after a restart. With a start value preset, the start value is counted down, otherwise the counting operation starts at the maximum value. The actuator transmits an "ON"-telegram via the object "Operating hours counter elapsed" for the output concerned once the value "0" is reached.

i The value of the communication object "Operating hours counter elapsed" is stored permanently. On switching on the bus voltage or after an ETS programming operation, the object is initialised with the most recently saved value. If an operating hours counter is in this case identified as elapsed, i. e. if the object value is a "ON", an additional telegram will be actively transmitted to the KNX as soon as the configured transmit delay has elapsed after the bus voltage returns. If the counter has not yet elapsed (object value "OFF"), no telegram is transmitted on bus voltage return or after an ETS programming operation.

i With a limiting or start value preset via communication object: The values received via the object are first validly accepted and permanently saved internally after a restart of the operating hours counter. On switching on the supply voltage or after an ETS programming operation, the object is initialised with the most recently saved value. The values received will be lost in the case of a bus voltage failure or by an ETS programming operation if no counter restart was executed before. For this reason, when specifying a new start or limiting value it is advisable to always execute a counter restart afterwards as well. A standard value of 65,535 hours or 2,147,483,647 seconds is predefined provided that no limiting value or start value has been received yet via the ob-

ject. The values received and stored via the object are reset to the standard value if the operating hours counter is disabled in the parameters of the ETS and an ETS programming operation is being performed.

- i** With a limiting or start value predefined via object: If the start or limiting value is predefined with "0", the actuator will ignore a counter restart to avoid an undesired reset (e.g. in site operation -> operating hours already counted by manual operation).
- i** If the counter direction of an operating hours counter is reversed by reconfiguration in the ETS, a restart of the meter should always be performed after programming the actuator so that the counter is reinitialised.

Restarting the operating hours counter

The counter reading of the operating hours can be reset at any time by the communication object "Restart operating hours counter". The polarity of the reset telegram is predefined: "1" = Restart / "0" = No reaction.

In the up-counter the counter is initialised with the value "0" after a restart and in the down-counter initialised with the start value. If no start value was configured or predefined by the object, the start value is preset to 65,535 hours or 2,147,483,647 seconds.

During every counter restart, the initialised counter reading is transmitted actively to the KNX.

After a restart, the signal of a counter operation is also reset. At the same time, an "OFF" telegram is transmitted to the KNX via the object "Operating hours counter elapsed". In addition, the limiting or start value is initialised.

- i** If a new limiting or start value was predefined via the communication object, a counter restart should always be performed afterwards, too. Otherwise, the values received will be lost in the case of a bus voltage failure or by an ETS programming operation.
- i** If a start or limiting value is predefined with "0", there are different behaviours after a restart, depending on the principle of the value definition...
 - Preset as parameter:
The counter elapses immediately after a counter restart.
 - Preset via object:
A counter restart will be ignored to avoid an undesired reset (e. g. after installation of the devices with operating hours already being counted by manual operation). A limiting or start value greater than "0" must be predefined in order to perform the restart.

Setting the transmission behaviour

The current value of the operating hours counter is tracked continuously in the communication object "Value operating hours counter". The content of the object is transmitted to the KNX when there is a change by the set count interval or cyclically active. The object value can also be read out at any time (set read flag).

The operating hours counter must be enabled on the parameter page "Dimming channel ... -> DO... - General -> Enabled functions".

- Set the parameter "Automatic transmission of the counter value" on the parameter page "Dimming channel ... -> DO... - General -> Operating hours counter" to "After change by interval value". Set the "Counting value interval" to the desired value.

The counter reading is transmitted to the KNX as soon as it changes by the predefined counting value interval. After the bus voltage returns or after an ETS programming operation, the object value is transmitted automatically after "Delay after bus voltage returns" has elapsed if the current counter reading or a multiple of this corresponds to the counting value interval. A counter reading "0" is always transmitted in this case.

- Set the parameter "Automatic transmission of counting value" to "Cyclical".

The counter value is transmitted cyclically. The cycle time is defined via the parameter of the same name. After the bus voltage returns or an ETS programming operation, the counter reading is transmitted to the KNX for the first time after the configured cycle time has elapsed.

10.18.1 Operating hours counter parameters

Dimming channel ... -> DO... - General -> Enabled functions

| | |
|--|---------------------|
| Operating hours counter | Checkbox (yes / no) |
| The operating hours counter can be disabled or enabled here. | |

Dimming channel ... -> DO... - General -> Operating hours counter

| | |
|----------|--|
| Function | second counter (DPT 13.100) Hour counter (DPT 7.007) |
|----------|--|

The operating hours counter can either be configured as a second counter or alternatively as an hour counter.

Second counter: The actuator adds up the determined switch-on time accurately to the second for a switched-on dimming channel. The totalled operating seconds are added in a 4-byte counter and stored permanently in the device. The current counter reading can be transmitted cyclically to the KNX by the "Value operating hours counter reading" communication object or when there is a change in an interval value in acc. with DPT 13.100.

Hour counter: The actuator adds up the determined switch-on time accurately to the minute for a switched-on dimming channel in full operating hours. The totalled operating hours are added in a 2-byte counter and stored permanently in the device. The current counter reading can be transmitted cyclically to the KNX by the "Value operating hours counter reading" communication object or when there is a change in an interval value in acc. with DPT 7.007.

| | |
|-----------------|-----------------------------------|
| Type of counter | up-counter Down-counter |
|-----------------|-----------------------------------|

The operating hours counter can be configured as an up-counter or down-counter. The setting here influences the visibility of the other parameters and objects of the operating hours counter.

| | |
|---------------------------|--|
| Limiting value presetting | no yes, as specified in parameter yes, as received via object |
|---------------------------|--|

If the up-counter is used, a limiting value can optionally be predefined. This parameter defines whether the limiting value can be set via a separate parameter or adapted individually by a communication object from the bus. The "No" setting deactivates the limiting value.

This parameter is only visible in the configuration "Type of counter = up-counter".

| | |
|--|--|
| Limiting value (s)* | 0... 2147483647* |
| Limiting value (h)** | 0... 65535** |
| <p>The limiting value of the up-counter is set here. Once the limiting value is reached, an "ON" telegram is transmitted via the object "Operating hours counter elapsed". The counter itself continues until the maximum counter reading is reached and then stops.</p> <p>*: With second counter **: With hours counter</p> <p>This parameter is only visible if the parameter "Limiting value presetting" is set to "yes, as specified in parameter".</p> | |
| Start value preset | no yes, as specified in parameter yes, as received via object |
| <p>If the down-counter is used, a start value can optionally be predefined. This parameter defines whether the start value can be set via a separate parameter or adapted individually by a communication object from the bus. The setting "No" deactivates the start value.</p> <p>This parameter is only visible in the configuration "Type of counter = down-counter".</p> | |
| Start value (s)* | 0... 2147483647* |
| Start value (h)** | 0... 65535** |
| <p>The start value of the down-counter is set here. After the initialisation, the counter starts counting down the predefined value by the hour until the value "0". If this end value is reached, an "ON" telegram is transmitted via the object "Operating hours counter elapsed".</p> <p>*: With second counter **: With hours counter</p> <p>This parameter is only visible if the parameter "Start value preset" is set to "Yes, as specified in parameter".</p> | |
| Transmission behaviour of the counter value | cyclical after change by interval value |
| <p>The current counter reading of the operating hours counter can be transmitted actively to the KNX via the "Value operating hours counter" communication object.</p> <p>Cyclical: The counter reading is transmitted cyclically to the KNX and when there is a change.</p> <p>after change by interval value: The counter reading is transmitted to the KNX only when there is a change.</p> | |

| | |
|--|---|
| Time for cyclical transmission | 0...23 h 0...15...59 min 0...59 s |
| <p>This parameter defines the cycle time for the cyclical transmission.</p> <p>This parameter for the cycle time is only visible when parameter "Transmission behaviour of the counter value" is set to "Cyclically".</p> | |
| Counter value interval | 0...3600...2147483647* 0...1...65535** |
| <p>The interval of the counter value is set here for automatic transmission. The current counter reading is transmitted to the KNX after the time interval configured here.</p> <p>*: With second counter **: With hours counter</p> <p>This parameter is only visible when parameter "Transmission behaviour of the counter value" is set to "On change by interval value".</p> | |

10.18.2 Object list operating hours counter

| Object no. | Function | Name | Type | DPT | Flag |
|---|--|---------------------------------|--------|--------|-----------------|
| 239, 246, 253, 260 | Limiting value / starting value, operating hours counter | Dimming channel ... - Input | 4-byte | 13,100 | C, (R), W, -, A |
| <p>4-byte object for external specification of a limit value/starting value of the operating hours counter of a dimming output. Value range: 0...2,147,483,647 seconds This object is only available with the second counter.</p> | | | | | |
| Object no. | Function | Name | Type | DPT | Flag |
| 240, 247, 254, 261 | Limiting value / starting value, operating hours counter | Dimming channel ... - Input | 2-byte | 7,007 | C, (R), W, -, A |
| <p>2-byte object for external specification of a limit value/starting value of the operating hours counter of a dimming output. Value range: 0...65,535 hours This object is only available with the hour counter.</p> | | | | | |
| Object no. | Function | Name | Type | DPT | Flag |
| 241, 248, 255, 262 | Restart operating hours counter | Dimming channel ... - Input | 1-bit | 1,015 | C, (R), W, -, A |
| <p>1-bit object for resetting the operating hours counter of a dimming output ("1" = restart, "0" = no reaction).</p> | | | | | |
| Object no. | Function | Name | Type | DPT | Flag |
| 242, 249, 256, 263 | Value operating hours counter | Dimming channel ... - Output | 4-byte | 13,100 | C, R, -, T, A |
| <p>4-byte object to transmit or read out the current counter level of the operating hours counter of a dimming output. Value range: 0...2147483647 seconds In the event of a bus voltage failure, the value of the communication object is not lost and is actively transmitted to the bus after the bus voltage returns or after an ETS programming operation. In the as-delivered state, the value is "0". This object is only available with the second counter.</p> | | | | | |

| Object no. | Function | Name | Type | DPT | Flag |
|-----------------------|----------------------------------|---------------------------------|--------|-------|---------------|
| 243, 250, 257, 264 | Value operating hours counter | Dimming channel ... - Output | 2-byte | 7,007 | C, R, -, T, A |

2-byte object to transmit or read out the current counter level of the operating hours counter of a dimming output.

Value range: 0...65,535 hours

In the event of a bus voltage failure, the value of the communication object is not lost and is actively transmitted to the bus after the bus voltage returns or after an ETS programming operation. In the as-delivered state, the value is "0".

This object is only available with the hour counter.

| Object no. | Function | Name | Type | DPT | Flag |
|-----------------------|------------------------------------|---------------------------------|-------|-------|--------------------|
| 244, 251, 258, 265 | Operating hours counter elapsed | Dimming channel ... - Output | 1-bit | 1,002 | C, (R), -, T, A |

1-bit object to sign that the operating hours counter has elapsed (forwards counter = limit value reached / backwards counter = value "0" reached). With a message, the object value is actively transmitted to the KNX ("1" = message active / "0" = message inactive).

In the event of a bus voltage failure, the value of the communication object is not lost and is actively transmitted to the bus after the bus voltage returns or after an ETS programming operation.

10.19 Disabling function/Forced position

A disabling function, or alternatively, a forced position function can be configured for each dimming channel. In this respect, only one of these functions can be enabled for one dimming channel.

Setting disabling function as supplementary function

During an active disabling function, the KNX control of the dimming function concerned is overridden and locked. Continuous light switching, for example, can also be overridden. The deactivation of the disabling function can optionally take place using an additional 1-bit acknowledgement object. This prevents the deactivation of the disabling function by the disabling object.

- On the parameter page "Dimming channel ... -> DO... - General -> DA... - Enabled functions", set the parameter "Disabling function/Forced position" to "Disabling function".

The disabling function is enabled. The communication object "Disable" and the parameters of the disabling function on the parameter page "Dimming channel ... -> DO... - General -> DA... - Disabling function" become visible.

- Set the parameter "Polarity disabling object" to the desired polarity.
- Set the parameter "Beginning of the disabling function" to the required behaviour.

At the beginning of the disabling function, the configured behaviour will be executed and the bus control of the dimming channel locked.

With the "Switch off" setting, the output is switched off and remains in this state.

With the "Brightness value" setting, the channel sets the specified brightness value and remains in this brightness state.

The "Memory value (brightness value before last switch-off)" setting is used to set the brightness value that was active and internally stored before the last switch-off (via the "Switching" or "Central switching" object). After programming with the ETS, the value is predefined to maximum brightness. Only a bus voltage failure, however, does not delete the memory value.

In the "No reaction" setting, the dimming channel shows no response and remains in the brightness state last selected.

In the "Flashing" setting, the dimming channel is switched on and off cyclically during the disabling. The "Time for flashing of the disabling functions" is generally configured on the parameter page "General -> Times". During flashing, the logical switching state of the dimming channel is signalled back as "Switched on" and the brightness value as "Switch-on brightness". A soft ON/OFF function is not executed during flashing.

For disabling function without acknowledgement object...

- Deactivate the parameter "Confirmation".

No additional acknowledgement object is available. The disabling function is deactivated by the disabling object according to the set polarity.

- Set the parameter "End of the disabling function" to the required behaviour.

At the end of the disabling function, the configured behaviour will be executed and the bus control of the dimming channel enabled again.

With the "Switch off" setting, the output is switched off and remains in this state.

With the "Brightness value" setting, the channel sets the specified brightness value.

The "Memory value (brightness value before last switch-off)" setting is used to set the brightness value that was active and internally stored before the last switch-off (via the "Switching" or "Central switching" object). After programming with the ETS, the value is predefined to maximum brightness. Only a bus voltage failure, however, does not delete the memory value.

With "Tracked brightness value", the brightness value received during the disabling function or the brightness value set before the disabling function is tracked at the end of disabling. Any time functions still in progress will also be taken into account if necessary.

In the "No reaction" setting, the output shows no reaction and remains in the state last set by the disabling function.

In the "Flashing" setting, the dimming channel is switched on and off cyclically after the disabling. The flashing time is generally configured on the parameter page "General -> Times". During flashing, the logical switching state of the output is fed back as "Switched on". The flashing state remains active until another KNX command is received and thereby predefines another state.

For disabling function with acknowledgement object...

- Activate the parameter "Use acknowledgement".

The acknowledgement object is available. The disabling function can only be deactivated using the acknowledgement object by an "ON telegram". Telegrams to the disabling object according to the "Deactivate disabling" polarity are ignored by the actuator.

i "OFF" telegrams to the acknowledgement object do not product a reaction.

- Set the parameter "End of the disabling function after acknowledgement" to the required behaviour.

At the end of the disabling function, the configured behaviour will be executed and the bus control of the dimming channel enabled again.

With the "Switch off" setting, the output is switched off and remains in this state.

With the "Brightness value" setting, the channel sets the specified brightness value.

The "Memory value (brightness value before last switch-off)" setting is used to set the brightness value that was active and internally stored before the last switch-off (via the "Switching" or "Central switching" object). After programming with the ETS, the value is predefined to maximum brightness. Only a bus voltage failure, however, does not delete the memory value.

With "Tracked brightness value", the brightness value received during the disabling function or the brightness value set before the disabling function is tracked at the end of disabling. Any time functions still in progress will also be taken into account if necessary.

In the "No reaction" setting, the output shows no reaction and remains in the state last set by the disabling function.

In the "Flashing" setting, the dimming channel is switched on and off cyclically after the disabling. The flashing time is generally configured on the parameter page "General -> Times". During flashing, the logical switching state of the output is fed back as "Switched on". The flashing state remains active until another KNX command is received and thereby predefines another state.

- i** After a bus voltage failure or after programming the application or the parameters with the ETS, the disabling function is always deactivated (object value "0"). With the inverted setting ("1 = enabled; 0 = disabled"), a telegram update "0" must first be carried out after the initialisation until the disabling is activated.
- i** Updates of the disabling object from "Activated" to "Deactivated" do not produce a reaction.
- i** A disabled dimming channel can be still be operated manually!
- i** In the setting "Set tracked state": During a disabling function, the overridden functions of the actuator (switching, scenes) continue to be executed internally. Consequently, newly received bus telegrams are evaluated and time functions are triggered as well. At the end of the disabling, the tracked states are set.

Setting forced position function as supplementary function

The forced position function can also be combined with other functions of a dimming channel. With an active forced position, functions with a lower priority are overridden so that the dimming channel concerned is locked.

The forced position function possesses a separate 2-bit communication object. The first bit (bit 0) of the object "Forced position" indicates whether the dimming channel is switched off or switched on by force. If the dimming channel is switched on by force, an ETS parameter defines which brightness value it should be switched on to. The second bit (bit 1) activates or deactivates the restraint (see table below).

The behaviour of a dimming channel at the end of the forced-position function can be configured. In addition, the forced object can be initialised when the bus voltage returns.

| Bit 1 | Bit 0 | Function |
|-------|-------|--|
| 0 | x | Forced position not active -> normal control |
| 1 | 0 | Forced position active: switch off |
| 1 | 1 | Forced position active: switch on |

Bit coding of forced position

- On the parameter page "Dimming channel ... -> DO... - General -> DA... - Enabled functions", set the parameter "Disabling function/Forced position" to "Forced position".

The forced position function is enabled. The communication object "Forced position" and the parameters of the forced position function on the parameter page "Dimming channel ... -> DO... - General -> DA... - Forced position" become visible.

- Set the parameter "Forced position end 'Inactive'" to the required behaviour.

At the end of the forced position, the configured behaviour will be executed and the bus control of the dimming channel enabled again.

With the "No reaction" setting, the dimming channel remains in the state last set by the forced position.

With "Tracked brightness value", the brightness value received during the forced position function or the brightness value set before the function is adjusted at the end of the forced position. Any time functions still in progress will also be taken into account if necessary.

i Updates of the forced position object from "Forced position active" to "Forced position active" while maintaining the switching status or from "Forced position inactive" to "Forced position inactive" show no reaction.

i A forcibly activated dimming channel via the KNX can be still be operated manually!

i With the "Tracked brightness value" setting at the end of the forced position: During a forced position, the overridden functions of the actuator (switching, scenes) continue to be executed internally. Consequently, newly received bus telegrams are evaluated and time functions are triggered as well. At the forced end, the tracked states are set.

i The current state of the forced position object will be stored in case of bus voltage failure.

- Set the parameter "After bus voltage returns" to the required behaviour.

After the bus voltage returns, the configured state is transferred to the "Forced position" communication object. When a forced position is activated, the dimming channel is immediately activated and interlocked accordingly by the

forced control after the bus voltage returns until forced control is enabled via the KNX. The parameter "After bus voltage return" on the parameter page "Dimming channel ... - DA... - General" is not evaluated for the affected dimming channel.

In the "State before bus voltage failure" setting, the forced position state last selected and internally stored before bus voltage failure will be tracked after the bus voltage returns. An ETS programming operation deletes the stored state (reaction in that case same as with "No forced position active").

If the tracked state corresponds to "No forced position", the force-independent parameter "After bus voltage return" (parameter page "Dimming channel ... - DA... - General") will be executed when the bus voltage returns.

- i** After programming the application or parameters with the ETS, the forced position function is always deactivated (object value "0").

10.19.1 Disabling function/forced position parameter

Dimming channel ... -> DO... - General -> Enabled functions

| | |
|--|---|
| Disabling function / Forced position | no selection Disabling function Priority control |
| This parameter can define whether a disabling function or a forced position for the dimming output should be available. The disabling function is only configurable as an alternative to the forced position function. | |

Dimming channel ... -> DO... - General -> Disabling function

| | |
|---|--|
| Acknowledgement | Checkbox (yes / no) |
| The deactivation of the disabling function can optionally take place using an additional 1-bit acknowledgement object. This prevents the deactivation of the disabling function by the disabling object. Alternatively, the acknowledgement object is not available. In this case, disabling is deactivated via the disabling object. Parameter activated: The acknowledgement object is available. The disabling function can only be deactivated using the acknowledgement object by an "ON telegram". Telegrams to the disabling object according to the "Deactivate disabling" polarity are ignored by the actuator. Parameter deactivated: No additional acknowledgement object is available. The disabling function is deactivated by the disabling object according to the set polarity. | |
| Polarity of the locking object | 0 = enabled; 1 = disabled 1 = enabled; 0 = disabled |
| This parameter defines the polarity of the disabling object. This parameter is visible only if the disabling function is enabled. | |

| | |
|---|--|
| Beginning of disabling function | Switch off Brightness value Memory value (brightness before last switch-off) no reaction Flashing |
| <p>The behaviour of the dimming output at the beginning of the disabling function can be configured.</p> <p>This parameter is visible only if the disabling function is enabled.</p> <p>Switch off: At the start of the disabling function, the dimming output is switched off and locked.</p> <p>Brightness value: At the start of the disabling function, the dimming channel is set to the predefined brightness value and locked.</p> <p>Memory value: At the start of the disabling function, the active and internally saved value prior to the last switch-off is set (via the "Switching" or "Central switching" object).</p> <p>No reaction: At the start of a disabling function, the dimming channel shows no reaction and remains in the currently set state. Bus control of the dimming channel is then locked.</p> <p>Switch on: At the start of the disabling function, the dimming channel is switched on and locked.</p> <p>Flashing: The dimming channel flashes on and off during the disabling function and the bus control is locked during this time. The flashing time is configured generally for all channels on the parameter page "General". During the flashing, the logical switching state is "On 1" and the switch-on brightness is signalled back as brightness. A soft ON/OFF function is ignored during flashing.</p> | |

| | |
|--|--|
| End of disabling function | Switch off Brightness value Memory value (brightness before last switch-off) tracked brightness value no reaction Flashing |
| <p>The behaviour of the dimming output at the end of the disabling function can be configured.</p> <p>This parameter is visible only if the disabling function is enabled and acknowledgement is not used.</p> <p>Switch off: At the end of the disabling function, the dimming output is switched off and enabled again.</p> <p>Brightness value: At the end of the disabling function, the dimming channel is set to the predefined brightness value and enabled again.</p> <p>Memory value: At the end of disabling, the active and internally stored brightness value prior to the last switch-off is set (via the "Switching" or "Central switching" object).</p> <p>tracked brightness value: At the end of the disabling function, the state received during the disabling function or the state set before the disabling function is tracked with the appropriate brightness value. Any time functions still in progress will also be taken into account if necessary.</p> <p>No reaction: At the end of a disabling function, the dimming channel shows no reaction and remains in the currently set state. Bus control of the dimming channel is enabled again.</p> <p>Flashing: The dimming channel is enabled again for the bus control after the end of the disabling function and flashes on and off. The flashing time is configured generally for all channels on the parameter page "General". During the flashing, the logical switching state is "On 1" and the switch-on brightness is signalled back as brightness. A soft ON/OFF function is ignored during flashing. The flashing status remains active until another bus command is received and specifies another status.</p> | |

| | |
|---|--|
| End of disabling function after acknowledgement | Switch off Brightness value Memory value (brightness before last switch-off) tracked brightness value no reaction Flashing |
|---|--|

The behaviour of the dimming output at the end of the disabling function after successful confirmation can be configured. This parameter is visible only if the disabling function is enabled and acknowledgement is not used.

Switch off: On confirmation, the dimming output is switched off and enabled again.

Brightness value: On confirmation, the dimming channel is set to the predefined brightness value and enabled again.

Memory value: On confirmation, the active and internally stored brightness value prior to the last switch-off is set (via the "Switching" or "Central switching" object).

tracked brightness value: On confirmation, the state received during the disabling function or the state set before the disabling function is tracked with the appropriate brightness value. Any time functions still in progress will also be taken into account if necessary.

No reaction: On confirmation, the dimming channel shows no reaction and remains in the currently set state. Bus control of the dimming channel is enabled again.

Flashing: The dimming channel is enabled again for the bus control on confirmation and flashes on and off. The flashing time is configured generally for all channels on the parameter page "General". During the flashing, the logical switching state is "On 1" and the switch-on brightness is signalled back as brightness. A soft ON/OFF function is ignored during flashing. The flashing status remains active until another bus command is received and specifies another status.

Dimming channel ... -> DO... - General -> Forced position

| | |
|-------------------------------------|--|
| Forced position "Active, switch-on" | Brightness value no reaction Memory value (brightness before last switch-off) |
|-------------------------------------|--|

If the forced position is activated and restraint is "ON", you can define here how the dimming channel should behave.

Brightness value: The dimming channel is set to the predefined brightness value.

No reaction: The dimming channel shows no reaction and remains in the currently set state.

Memory value: The active and internally stored brightness value prior to the last switch-off is set (via the "Switching" or "Central switching" object).

| | |
|--|--|
| Forced position "Active, switch-off" | Switch off |
| <p>If forced position is activated and the restraint is "OFF", the dimming output is always switched off.</p> <p>This parameter cannot be edited and is only visible when the forced position function is enabled.</p> | |
| Forced position end "Inactive" | no reaction tracked brightness value |
| <p>The behaviour of the dimming channel at the end of the forced-position can be configured here.</p> <p>This parameter is only visible when the forced position function is enabled.</p> <p>no reaction: The output shows no reaction and remains in the state last set by the forced position.</p> <p>tracked brightness value: At the end of the forced position, the state received during the forced position function or the state set before the function is tracked with the appropriate brightness value. Any time functions still in progress will also be taken into account if necessary. Bus control of the dimming channel is enabled again.</p> | |
| After the bus voltage returns | No forced position Forced position active, switch on Forced position active, switch off State before bus voltage failure |
| <p>The forced position communication object can be initialised after the bus voltage returns. The brightness status of the dimming channel can be influenced when the forced position function is activated.</p> <p>This parameter is only visible when the forced position function is enabled.</p> <p>no forced position: No forced position is activated after the bus voltage returns. Reaction of the dimming channel according to the parameter "Behaviour after bus voltage returns".</p> <p>Forced position active, switch on: The forced position is activated. The dimming channel is switched on to the brightness value predefined by the parameter "Switch on brightness for 'active' forced position".</p> <p>Forced position active, switch off: The forced position is activated. The dimming output is switched off under forced control.</p> <p>State before bus voltage failure: The forced position state last selected and internally stored before bus voltage failure will be tracked after the bus voltage returns. An ETS programming operation deletes the stored state (reaction in that case same as with "No forced position active"). If the tracked state corresponds to "No forced position", the force-independent parameter "After bus voltage return" (parameter page "Dimming channel ... -> DO... - General") will be executed when the bus voltage returns.</p> | |

10.19.2 Object list for disabling function/forced position

| Object no. | Function | Name | Type | DPT | Flag |
|--|--------------------------|--------------------------------|-------|-------|-----------------|
| 39, 59, 79, 99 | Disabling | Dimming channel ... - Input | 1-bit | 1,003 | C, (R), W, -, A |
| 1-bit object for disabling a dimming channel (polarity configurable). | | | | | |
| Object no. | Function | Name | Type | DPT | Flag |
| 40, 60, 80, 100 | Priority control | Dimming channel ... - Input | 2-bit | 2,001 | C, (R), W, -, A |
| 2-bit object for the forced position of a dimming channel. The polarity is fixed by the telegram. | | | | | |
| Object no. | Function | Name | Type | DPT | Flag |
| 47, 67, 87, 107 | Disabling acknowledgment | Dimming channel ... - Input | 1-bit | 1,016 | C, (R), W, -, A |
| 1-bit object to confirm an active disabling function of a dimming channel. This object is only visible if the acknowledgement is to be used with the disabling function ("1" = Disabling function is deactivated / "0" = disabling function remains active). | | | | | |

11 Logic functions

The device contains up to 8 logic functions. Simple logical operations in a KNX installation can be performed using these functions. Linking of input and output objects allows the networking of logic functions, permitting the execution of complex operations.

Enabling and configuring the number of logic functions

To be able to use logic functions, they must be enabled centrally on the "General" parameter page.

- Activate the parameter "Use logic functions".

The logic functions can be used. The "Logic functions" parameter node becomes available, which contains additional parameter pages. The configuration of the logic functions takes place in this parameter node.

Logic functions can be enabled in steps so that the number of visible functions and, in consequence, the available parameters and communication objects are visible in the ETS. The number of available logic functions can be defined on the "Logic functions" parameter page.

- Configure the "Number of logic functions" parameter to the desired value.

As many logic functions are created as have been selected.

- i** The application program deletes existing logic functions from the configuration if the number of available functions is reduced.

11.1 Logic functions parameters

General

| Logic functions | Checkbox (yes / no) |
|---|---------------------|
| This parameter enables the logic functions globally. If the parameter is activated, the "Logic functions" parameter node becomes available, which contains additional parameter pages. The configuration of the logic functions takes place in this parameter node. | |

| Number of logic functions (1...8) | 1...8 |
|---|-------|
| The number of required logic functions is defined here. | |

Logic functions -> Logic function...

| Name of logic function | Free text |
|--|-----------|
| The text entered in this parameter is applied to the name of the communication objects and is used for labelling the logic function in the ETS parameter window The text is not programmed in the device. | |

| | |
|---|--|
| <p>Type of logic function</p> | <p>Logic gate Converter (1-bit -> 1-byte) Disabling element (filtering/time) Comparator Limit value switch with hysteresis</p> |
| <p>It is possible to be define which logical operation is to be executed for each logic function. This parameter is only visible if the logic functions have been enabled on the "General" parameter page.</p> <p>Logic gate: The logic function works as a Boolean logic gate with optionally 1 ... 4 inputs and one output.</p> <p>Converter (1-bit -> 1-byte): The logic function is configured as a converter. The converter has a 1-bit input and a 1-byte output and also a disabling object. ON / OFF telegrams can be converted to preconfigured values. The disabling object is able to deactivate the converter.</p> <p>Disabling element (Filtering/Time): The logic function is configured as a disabling element. The disabling element has a 1-bit input and a 1-bit output. This logic function can delay input signals depending on the state (ON or OFF) and output them filtered at the output. A disabling object is also available, which can be used to deactivate the disabling element.</p> <p>Comparator: The logic function works as a comparator with an input whose data format can be parameterised, and with a 1-bit output to output the result of the comparison operation. The reference function and the reference value are configured in the ETS.</p> <p>Limit value switch with hysteresis: The logic function acts like a limit switch with hysteresis. An input with a configurable data format and a 1-bit output are available. The hysteresis is determined by an upper and lower threshold. The threshold values can be parameterised in the ETS. The input value is compared with the threshold values. The command at the output (ON / OFF) upon exceeding or falling below the configured threshold values can be configured.</p> | |

11.2 Logic gate

A logic gate has up to 4 Boolean inputs (1-bit) and one logic output (1-bit). In consequence, a logic operation only supports the 1-bit data format. The following table shows configurable comparison operations Logic gate and explains their function.

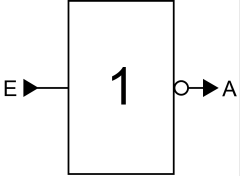
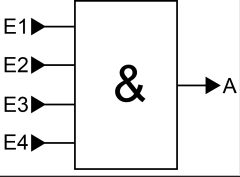
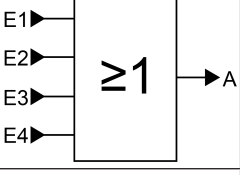
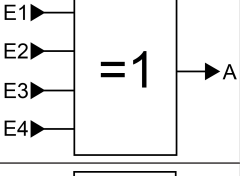
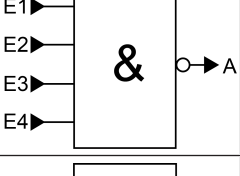
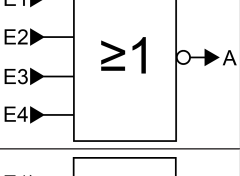
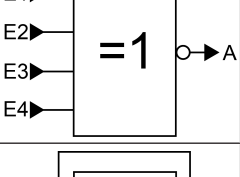
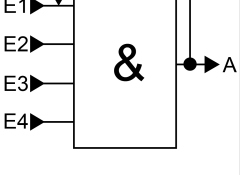
| Logic gate | Description | Icon |
|------------------------------|---|---|
| Invert (NOT) | The logic gate has only one input. The input is forwarded to the gate output inverted. |  |
| AND (AND) | Logic gate has 4 inputs. The output is "1" if all inputs are "1". Otherwise the output is "0". |  |
| OR (OR) | Logic gate has 4 inputs. The output is "0" if all inputs are "0". Otherwise the output is "1". |  |
| Exclusive OR (XOR) | Logic gate has 4 inputs. The output is "1" if only one input is "1". Otherwise the output is "0". |  |
| inverted And (NAND) | Logic gate has 4 inputs. The output is "0" if all inputs are "1". Otherwise the output is "1". |  |
| inverted Or (NOR) | Logic gate has 4 inputs. The output is "1" if all inputs are "0". Otherwise the output is "0". |  |
| inverted Exclusive OR (NXOR) | Logic gate has 4 inputs. The output is "0" if only one input is "1". Otherwise the output is "1". |  |
| AND with feedback (ANDR) | Logic gate has 4 inputs. The output is fed back to the first input of the gate. The output is "1" if all inputs are "1". Otherwise the output is "0". If input 1 is set to "1" and the output is still "0", the feedback of input 1 is also reset to "0". Only when |  |

| Logic gate | Description | Icon |
|------------|---|------|
| | inputs 2 ... 4 are "1" will a newly received "1" at input 1 cause the output to assume the logical state "1". Application: Switch light manually only at twilight -> Switch on input 1, twilight sensor on input 2 -> The manual switching signal is ignored for as long as the twilight sensor has not issued an enabling signal. The manual switching sign is only executed at twilight. | |

Inputs of a logic gate can be activated or deactivated separately. This allows gates with an individual number of inputs (1 ... 4) to be implemented. As an option, it is possible to invert inputs.

The transmission behaviour of the gate output can be configured.

11.2.1 Logic gate parameters

Logic functions -> Logic function...

| | |
|---|---|
| Selection logic gate | Invert (NOT) AND (AND) OR (OR) Exclusive OR (XOR) inverted And (NAND) inverted Or (NOR) inverted Exclusive OR (NXOR) AND with feedback (ANDR) |
| <p>This parameter defines the function of the logic gate and is only visible if "Type of logic function = logic gate".</p> <p>Invert (NOT): The inverter is configured. The gate has one input and one output. The Boolean data value of the input is forwarded to the output inverted.</p> <p>And (AND): An AND gate is configured. The gate has 1...4 inputs and one output. The inputs are logically AND-linked. The result is forwarded to the output.</p> <p>OR (OR): An OR gate is configured. The gate has 1...4 inputs and one output. The inputs are logically OR-linked. The result is forwarded to the output.</p> <p>Exclusive-OR (XOR): An exclusive-OR gate is configured. The gate has 1...4 inputs and one output. The inputs are logically Exclusive-OR-linked. The result is forwarded to the output.</p> <p>inverted AND (NAND): An inverted AND gate is configured. The gate has 1...4 inputs and one output. The inputs are logically AND-linked. The result is forwarded to the output inverted.</p> <p>inverted OR (NOR): An OR gate is configured. The gate has 1...4 inputs and one output. The inputs are logically OR-linked. The result is forwarded to the output inverted.</p> <p>inverted Exclusive OR (NXOR): An inverted Exclusive OR gate is configured. The gate has 1...4 inputs and one output. The inputs are logically Exclusive-OR-linked. The result is forwarded to the output inverted.</p> <p>AND with feedback (ANDR): An AND gate with feedback is configured. The gate has 1...4 inputs and one output. The output is fed back to the first input of the gate.</p> | |
| Input 1 | deactivated Input object |
| <p>Inputs of a logic gate can be activated or deactivated separately. This allows gates with an individual number of inputs (1 ... 4) to be implemented. This parameter defines whether the first input of the gate should be used.</p> <p>This parameter is only visible if "Type of logic function = logic gate".</p> | |

| | |
|--|---|
| Input 2 | deactivated Input object |
| <p>Inputs of a logic gate can be activated or deactivated separately. This allows gates with an individual number of inputs (1 ... 4) to be implemented. This parameter defines whether the second input of the gate should be used.</p> <p>This parameter is only visible if "Type of logic function = logic gate".</p> | |
| Input 3 | deactivated Input object |
| <p>Inputs of a logic gate can be activated or deactivated separately. This allows gates with an individual number of inputs (1 ... 4) to be implemented. This parameter defines whether the third input of the gate should be used.</p> <p>This parameter is only visible if "Type of logic function = logic gate".</p> | |
| Input 4 | deactivated Input object |
| <p>Inputs of a logic gate can be activated or deactivated separately. This allows gates with an individual number of inputs (1 ... 4) to be implemented. This parameter defines whether the fourth input of the gate should be used.</p> <p>This parameter is only visible if "Type of logic function = logic gate".</p> | |
| Invert input | Checkbox (yes / no) |
| <p>It is possible to invert inputs of the logic gate as an option. This parameter is available for each input of the gate and defines whether the respective input should be evaluated unchanged or inverted.</p> <p>This parameter is only visible if "Type of logic function = logic gate".</p> | |
| Transmission criteria | always transmit when the input is updated transmit only if the output changes transmit cyclically |
| <p>The transmission behaviour of the output can be configured here.</p> <p>always transmit when the input is updated: The output transmits the current object value to the KNX with every telegram that is received at the input.</p> <p>transmit only if the output changes: The output only transmits the current object value if the object value has changed compared to the last transmission process. The output always transmits during the first telegram to an input after the bus voltages return or after an ETS programming operation.</p> <p>transmit cyclically: With this setting, the output transmits the current object value to the KNX cyclically. After the bus voltage returns or after an ETS programming operation, the cyclical transmission is not started until the first telegram has been received at the input. The output also transmits as soon as a new telegram is received at the input. At the same time, the cycle time for cyclical transmission is restarted!</p> | |

| | |
|---|------------|
| Transmission delay for sending the hours result (0...99) | 0...99 |
| <p>An optional delay before result transmission (telegram at output) can be configured.</p> <p>With the setting "Always transmit when the input is updated": Telegrams at the output are only transmitted after the trigger when the delay has elapsed. The delay time is restarted by each telegram at the input.</p> <p>With the setting "Only transmit if the output changes": Telegrams are only sent when the object value changes at the output if the delay has expired. If the logic function is reprocessed by a new telegram at the input within the delay time and the object value changes again, then the delay restarts. If the object value of the output does not change due to new input telegrams, the delay does not restart.</p> <p>This parameter defines the hours of the delay time.</p> | |
| Minutes (0...59) | 0...59 |
| <p>This parameter defines the minutes of the delay time.</p> | |
| Seconds (0...59) | 0...59 |
| <p>This parameter defines the seconds of the delay time.</p> <p>The parameters for the transmission delay are only visible for "Transmission criteria" = "Always transmit when the input is updated" and "Only transmit when the output changes".</p> | |
| Cycle time hours (0...99) | 0...99 |
| <p>During cyclical transmission of the output, this parameter defines the cycle time.</p> <p>Setting the cycle time hours.</p> | |
| Minutes (0...59) | 0...5...59 |
| <p>This parameter defines the minutes of the cycle time.</p> | |
| Seconds (0...59) | 0...59 |
| <p>This parameter defines the seconds of the cycle time.</p> <p>The parameters for the cycle time are only visible if "Transmission criteria" = "Transmit cyclically".</p> | |

11.2.2 Object list for logic gate

| Object no. | Function | Name | Type | DPT | Flag |
|--|----------------------|------------------|-------|-------|--------------------|
| 295, 299, 303, 307, 311, 315, 319, 323 | Logic gate...Input 1 | Logic... - Input | 1-bit | 1,002 | C, (R), W, -, A |
| <p>1-bit object as input 1 of a logic gate (1...8). The input status can be inverted optionally.</p> <p>This object is only available if the type of logic function is configured to "Logic gate" and input 1 is used.</p> | | | | | |

| Object no. | Function | Name | Type | DPT | Flag |
|--|----------------------|------------------|-------|-------|--------------------|
| 296, 300, 304, 308, 312, 316, 320, 324 | Logic gate...Input 2 | Logic... - Input | 1-bit | 1,002 | C, (R), W, -, A |
| <p>1-bit object as input 2 of a logic gate (1...8). The input status can be inverted optionally.</p> <p>This object is only available if the type of logic function is configured to "Logic gate" and input 2 is used.</p> | | | | | |

| Object no. | Function | Name | Type | DPT | Flag |
|--|----------------------|------------------|-------|-------|--------------------|
| 297, 301, 305, 309, 313, 317, 321, 325 | Logic gate...Input 3 | Logic... - Input | 1-bit | 1,002 | C, (R), W, -, A |
| <p>1-bit object as input 3 of a logic gate (1...8). The input status can be inverted optionally.</p> <p>This object is only available if the type of logic function is configured to "Logic gate" and input 3 is used.</p> | | | | | |

| Object no. | Function | Name | Type | DPT | Flag |
|--|----------------------|------------------|-------|-------|--------------------|
| 298, 302, 306, 310, 314, 318, 322, 326 | Logic gate...Input 4 | Logic... - Input | 1-bit | 1,002 | C, (R), W, -, A |
| <p>1-bit object as input 4 of a logic gate (1...8). The input status can be inverted optionally.</p> <p>This object is only available if the type of logic function is configured to "Logic gate" and input 4 is used.</p> | | | | | |

| Object no. | Function | Name | Type | DPT | Flag |
|--|-------------------|-------------------|-------|-------|--------------------|
| 383, 385, 387, 389, 391, 393, 395, 397 | Logic gate output | Logic... - Output | 1-bit | 1,002 | C, (R), -, T, A |
| <p>1-bit object as output of a logic gate (1...8).</p> <p>This object is only available if the type of logic function is configured to "Logic gate".</p> | | | | | |

11.3 Converter (1-bit -> 1-byte)

The converter has a 1-bit input and a 1-byte output and also a disabling object. ON / OFF telegrams can be converted to preconfigured values. The disabling object is able to deactivate the converter.

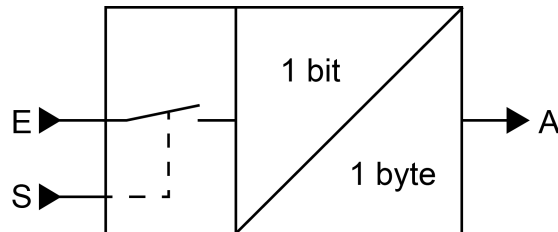

Figure 27: Converter (1-bit -> 1-byte)

The converter can react differently to input states. The parameter "Reaction at input to" defines whether the converter responds to ON and OFF commands or alternatively only processes ON or OFF telegrams.

A concrete 1-byte output value can be assigned to each 1-bit input status. The two output values can be configured anywhere in the range 0 ... 255 as required. The data format of the converter output object is set to DPT 5.001 (0...100%).

The disabling object can be deactivated via the converter. A deactivated converter no longer processes input states and consequently does not convert any new output values (the last value is retained and transmitted cyclically, if necessary). At the end of a disabling function, the converter is enabled again. The converter then waits for the next telegram at the input.

The telegram polarity of the disabling object can be configured.

The transmission behaviour of the converter output can be configured.

11.3.1 Converter parameters

Logic functions -> Logic function...

| | |
|---|--|
| Reaction at input to | ON and OFF telegrams ON telegrams OFF telegrams |
| The converter can react differently to input states. It is defined here whether the converter responds to ON and OFF commands or alternatively only processes ON or OFF telegrams. | |
| Polarity of the locking object | 0 = enabled / 1 = disabled 0 =disabled/ 1 = enabled |
| This parameter defines the polarity of the disabling object. | |
| Output value for ON (0...255) | 0...255 |
| A concrete 1-byte output value can be assigned to each 1-bit input status. This parameter defines the output value for ON telegrams. This parameter is only visible when the input should react to ON telegrams. | |
| Output value for OFF (0...255) | 0...255 |
| A concrete 1-byte output value can be assigned to each 1-bit input status. This parameter defines the output value for OFF telegrams. This parameter is only visible when the input should react to OFF telegrams. | |
| Transmission criteria | always transmit when the input is updated transmit only if the output changes transmit cyclically |
| <p>The transmission behaviour of the output can be configured here.</p> <p>always transmit when the input is updated: The output transmits the current object value to the KNX with every telegram that is received at the input.</p> <p>transmit only if the output changes: The output only transmits the current object value if the object value has changed compared to the last transmission process. The output always transmits during the first telegram to an input after the bus voltages return or after an ETS programming operation.</p> <p>transmit cyclically: With this setting, the output transmits the current object value to the KNX cyclically. After the bus voltage returns or after an ETS programming operation, the cyclical transmission is not started until the first telegram has been received at the input. The output also transmits as soon as a new telegram is received at the input. At the same time, the cycle time for cyclical transmission is restarted!</p> | |

| | |
|--|------------|
| Transmission delay for sending the hours result (0...99) | 0...99 |
| <p>An optional delay before result transmission (telegram at output) can be configured. With the setting "Always transmit when the input is updated": Telegrams at the output are only transmitted after the trigger when the delay has elapsed. The delay time is restarted by each telegram at the input.</p> <p>With the setting "Only transmit if the output changes": Telegrams are only sent when the object value changes at the output if the delay has expired. If the logic function is reprocessed by a new telegram at the input within the delay time and the object value changes again, then the delay restarts. If the object value of the output does not change due to new input telegrams, the delay does not restart.</p> <p>This parameter defines the hours of the delay time.</p> | |
| Minutes (0...59) | 0...59 |
| <p>This parameter defines the minutes of the delay time.</p> | |
| Seconds (0...59) | 0...59 |
| <p>This parameter defines the seconds of the delay time.</p> <p>The parameters for the transmission delay are only visible for "Transmission criteria" = "Always transmit when the input is updated" and "Only transmit when the output changes".</p> | |
| Cycle time hours (0...99) | 0...99 |
| <p>During cyclical transmission of the output, this parameter defines the cycle time. Setting the cycle time hours.</p> | |
| Minutes (0...59) | 0...5...59 |
| <p>This parameter defines the minutes of the cycle time.</p> | |
| Seconds (0...59) | 0...59 |
| <p>This parameter defines the seconds of the cycle time.</p> <p>The parameters for the cycle time are only visible if "Transmission criteria" = "Transmit cyclically".</p> | |

11.3.2 Object list for converter

| Object no. | Function | Name | Type | DPT | Flag |
|---|-----------------|------------------|-------|-------|--------------------|
| 295, 299, 303, 307, 311, 315, 319, 323 | Converter Input | Logic... - Input | 1-bit | 1,002 | C, (R), W, -, A |

1-bit object as input of a converter. It is possible to configure whether the converter responds to ON and OFF commands or alternatively processes only ON or only OFF telegrams.

This object is only available if the type of logic function is configured to "Converter".

| Object no. | Function | Name | Type | DPT | Flag |
|---|---------------------------------|------------------|-------|-------|--------------------|
| 296, 300, 304, 308, 312, 316, 320, 324 | Converter Disabling function | Logic... - Input | 1-bit | 1,002 | C, (R), W, -, A |

1-bit object as disabling input of a converter. A disabled converter no longer processes input states and consequently does not convert any new output values (the last value is retained and transmitted cyclically, if necessary).

The telegram polarity can be configured.

This object is only available if the type of logic function is configured to "Converter".

| Object no. | Function | Name | Type | DPT | Flag |
|---|------------------|-------------------|--------|-------|--------------------|
| 431, 432, 433, 434, 435, 436, 437, 438 | Converter Output | Logic... - Output | 1-byte | 5,001 | C, (R), -, T, A |

1-byte object as value output of a converter.

This object is only available if the type of logic function is configured to "Converter".

11.4 Disabling element (filtering/time)

The disabling element has a 1-bit input and a 1-bit output as well as a disabling object. Input states (ON/OFF) can be delayed independently of one another and filtered at the output before output. The filter makes it possible to invert the states of the output (e. g. ON -> OFF) or to suppress it completely (e. g. OFF -> ---, OFF is not transmitted). If the filter is not used, the disabling element only works with the time functions if required. Alternatively, it is possible to use only the filter (without delays).

The disabling object is able to deactivate the disabling element.

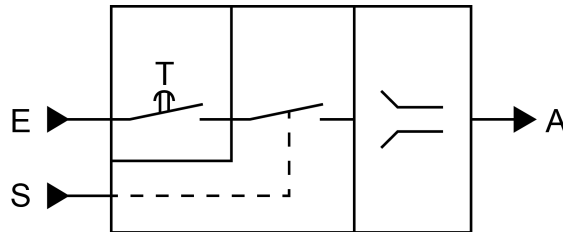

Figure 28: Disabling element (filtering/time)

The parameter "Time function" defines whether ON or OFF telegrams or both states are evaluated with a delay after reception at the input. If a delay is provided, the delay time can be configured separately for ON and OFF telegrams. A delay is only effective if the delay time is set to greater than "0". Each telegram received at the input re-triggers the receptive delay time.

If no delay is configured, the input telegrams go directly into the filter.

i Special feature when using the delays: If no telegram is received at the input, a configured delay time (time > 0) acts like an automatic cyclic trigger of the filter. The most recently received input status is then forwarded to the filter automatically and repeatedly after the delay has elapsed. This then works according to its configuration and forwards the result to the output of the disabling element. Consequently, the output then also transmits telegrams depending on the transmission criteria set. If the cyclical transmission of the output is not desired due to the automatic triggering of the filter, the transmission criterion should be set to "Only transmit if the output changes".

If no delay is provided, the filter is only triggered automatically via the received telegrams and thus not automatically.

i After the bus voltage returns or after an ETS programming operation, the delays are triggered automatically.

The filter is set by the parameter "Filter function" according to the following table.

| Filter function | Result |
|------------------------|---|
| ON -> ON / OFF -> OFF | Input telegrams are forwarded to the output unchanged. Filter deactivated. |
| ON -> --- / OFF -> OFF | ON telegrams are filtered and not forwarded to the output. OFF telegrams are forwarded to the output unchanged. |

| Filter function | Result |
|------------------------|--|
| ON -> ON / OFF -> --- | OFF telegrams are filtered and not forwarded to the output. ON telegrams are forwarded to the output unchanged. |
| ON -> OFF / OFF -> ON | ON telegrams are converted to OFF telegrams and OFF telegrams are converted to ON telegrams and are forwarded to the output. |
| ON -> --- / OFF -> ON | ON telegrams are filtered and not forwarded to the output. OFF telegrams are converted to ON telegrams and forwarded to the output. |
| ON -> OFF / OFF -> --- | OFF telegrams are filtered and not forwarded to the output. ON telegrams are converted to OFF telegrams and forwarded to the output. |

The disabling element can be deactivated by the disabling object. A deactivated disabling element no longer forwards any input states to the filter and consequently does not convert any new output values (the last value is retained and transmitted cyclically, if necessary). However, the input states are still evaluated (even with effective delays). At the end of a disabling function, the disabling element is enabled again. The disabling element waits for the next telegram at the input or for the next cycle of the configured delay times.

The telegram polarity of the disabling object can be configured.

The transmission behaviour of the disabling element output can be configured.

11.4.1 Disabling element parameters

Logic functions -> Logic function...

| | |
|---------------|--|
| Time function | no delay delay only ON telegrams delay only OFF telegrams Delay ON and OFF telegrams |
|---------------|--|

This parameter defines whether ON or OFF telegrams or both states are evaluated with a delay after reception at the input. If a delay is provided, the delay time can be configured separately for ON and OFF telegrams. If no delay is configured, the input telegrams go directly into the filter.

| | |
|--|--------|
| Delay for ON telegrams Minutes (0...59) | 0...59 |
|--|--------|

The delay for ON telegrams is configured here. A delay is only effective if the delay time is set to greater than "0". Each ON telegram received at the input re-triggers the delay time.

Special feature when using the delays: If no telegram is received at the input, a configured delay time (time > 0) acts like an automatic cyclic trigger of the filter. The most recently received input status is then forwarded to the filter automatically and repeatedly after the delay has elapsed. This then works according to its configuration and forwards the result to the output of the disabling element. Consequently, the output then also transmits telegrams depending on the transmission criteria set. If the cyclical transmission of the output is not desired due to the automatic triggering of the filter, the transmission criterion should be set to "Only transmit if the output changes".

After the bus voltage returns or after an ETS programming operation, the delays are triggered automatically.

Setting the ON delay time minutes.

| | |
|------------------|-------------|
| Seconds (0...59) | 0...10...59 |
|------------------|-------------|

Setting the seconds of the ON delay time.

The parameters for the ON delay are only available if the parameter "Time function" is set to "Only delay ON telegrams" or "Delay ON and OFF telegrams".

| | |
|---|--------|
| Delay for OFF telegrams Minutes (0...59) | 0...59 |
|---|--------|

The delay for OFF telegrams is configured here. A delay is only effective if the delay time is set to greater than "0". Each OFF telegram received at the input re-triggers the delay time.

Special feature when using the delays: If no telegram is received at the input, a configured delay time (time > 0) acts like an automatic cyclic trigger of the filter. The most recently received input status is then forwarded to the filter automatically and repeatedly after the delay has elapsed. This then works according to its configuration and forwards the result to the output of the disabling element. Consequently, the output then also transmits telegrams depending on the transmission criteria set. If

| | |
|--|--|
| Delay for OFF telegrams Minutes (0...59) | 0...59 |
| <p>the cyclical transmission of the output is not desired due to the automatic triggering of the filter, the transmission criterion should be set to "Only transmit if the output changes".</p> <p>After the bus voltage returns or after an ETS programming operation, the delays are triggered automatically.</p> <p>Setting the OFF delay time minutes.</p> | |
| Seconds (0...59) | 0...10...59 |
| <p>Setting the OFF delay time seconds.</p> <p>The parameters for the OFF delay are only available if the parameter "Time function" is set to "Only delay OFF telegrams" or "Delay ON and OFF telegrams".</p> | |
| Polarity of the locking object | 0 = enabled / 1 = disabled 0 =disabled/ 1 = enabled |
| <p>This parameter defines the polarity of the disabling object.</p> | |
| Filter function | ON -> ON / OFF -> OFF ON -> --- / OFF -> OFF ON -> ON / OFF -> --- ON -> OFF / OFF -> ON ON -> --- / OFF -> ON ON -> OFF / OFF -> --- |
| <p>This parameter defines the function of the filter.</p> <p>ON -> ON / OFF -> OFF: Input telegrams are forwarded to the output unchanged. Filter deactivated.</p> <p>ON -> --- / OFF -> OFF: ON telegrams are filtered and not forwarded to the output. OFF telegrams are forwarded to the output unchanged.</p> <p>ON -> ON / OFF -> ---: OFF telegrams are filtered and not forwarded to the output. ON telegrams are forwarded to the output unchanged.</p> <p>ON -> OFF / OFF -> ON: ON telegrams are converted to OFF telegrams and OFF telegrams are converted to ON telegrams and forwarded to the output.</p> <p>ON -> --- / OFF -> ON: ON telegrams are filtered and not forwarded to the output. OFF telegrams are converted to ON telegrams and forwarded to the output.</p> <p>ON -> OFF / OFF -> ---: OFF telegrams are filtered and not forwarded to the output. ON telegrams are converted to OFF telegrams and forwarded to the output.</p> | |
| Transmission criteria | always transmit when the input is updated transmit only if the output changes transmit cyclically |
| <p>The transmission behaviour of the output can be configured here.</p> | |

| | |
|---|---|
| Transmission criteria | <p>always transmit when the input is updated transmit only if the output changes transmit cyclically</p> |
| <p>always transmit when the input is updated: The output transmits the current object value to the KNX with every telegram that is received at the input. In addition, transmission at the output is repeated if no telegram was received at the input when the delay times were used and the configured time has expired.</p> <p>transmit only if the output changes: The output only transmits the current object value if the object value has changed compared to the last transmission process. After the bus voltage returns or an ETS programming operation, the output always transmits.</p> <p>transmit cyclically: With this setting, the output transmits the current object value to the KNX cyclically. After the bus voltage returns or after an ETS programming operation, the cyclical transmission is not started until the first telegram has been received at the input. If the ON/OFF delay is used, the cyclical transmission starts automatically once the delay time has expired after the bus voltage returns or after an ETS programming operation. The output also transmits as soon as a new telegram is received at the input. At the same time, the cycle time for cyclical transmission is re-started!</p> | |
| Cycle time hours (0...99) | 0...99 |
| <p>During cyclical transmission of the output, this parameter defines the cycle time. Setting the cycle time hours.</p> | |
| Minutes (0...59) | 0...5...59 |
| <p>This parameter defines the minutes of the cycle time.</p> | |
| Seconds (0...59) | 0...59 |
| <p>This parameter defines the seconds of the cycle time.</p> <p>The parameters for the cycle time are only visible if "Transmission criteria" = "Transmit cyclically".</p> | |

11.4.2 Object list for disabling element

| Object no. | Function | Name | Type | DPT | Flag |
|---|----------------------------|------------------|-------|-------|--------------------|
| 295, 299, 303, 307, 311, 315, 319, 323 | Disabling element Input | Logic... - Input | 1-bit | 1,002 | C, (R), W, -, A |
| <p>1-bit object as input of a disabling element.</p> <p>This object is only available if the type of logic function is configured to "Disabling element".</p> | | | | | |

| Object no. | Function | Name | Type | DPT | Flag |
|---|---|------------------|-------|-------|--------------------|
| 296, 300, 304, 308, 312, 316, 320, 324 | Disabling element Disabling function | Logic... - Input | 1-bit | 1,002 | C, (R), W, -, A |
| <p>1-bit object as disabling input of a disabling element. A disabled disabling element no longer forwards any input states to the filter and consequently does not convert any new output values (the last value is retained and transmitted cyclically, if necessary).</p> <p>The telegram polarity can be configured.</p> <p>This object is only available if the type of logic function is configured to "Disabling element".</p> | | | | | |

| Object no. | Function | Name | Type | DPT | Flag |
|--|-----------------------------|-------------------|-------|-------|--------------------|
| 384, 386, 388, 390, 392, 394, 396, 398 | Disabling element Output | Logic... - Output | 1-bit | 1,002 | C, (R), -, T, A |
| <p>1-bit object as output of a disabling element.</p> <p>This object is only available if the type of logic function is configured to "Disabling element".</p> | | | | | |

11.5 Comparator

The comparator works with an input whose data format can be parameterised, and with a 1-bit output to output the result of the comparison operation. The comparator compares the value received at the input with a configured reference value and evaluates whether the reference is correct (result = true) or not (result = false) according to the specified reference function.

The reference function and the reference value are configured in the ETS.

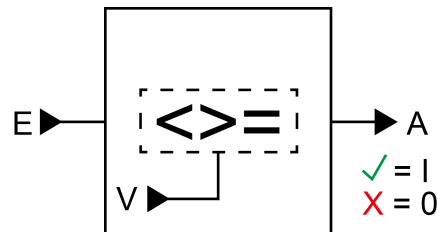

Figure 29: Comparator

The parameter "Data format" defines the size and format of input object according to the following table. The output object is preset to 1-bit (DPT 1.002) and outputs the result of the comparison operation (ON = true / OFF = false). The reference value that can be set in the ETS adapts to the input data format.

| Data format | KNX DPT |
|---------------------------------------|---------|
| 4-bit dimming | 3,007 |
| 1-byte operating mode switchover | 20,102 |
| 1-byte scene extension unit | 18,001 |
| 1-byte value 0...255 | 5,010 |
| 1-byte brightness value 0...100% | 5,001 |
| 2-byte value 0...65535 | 7,001 |
| 2-byte value -32768...32767 | 8,001 |
| 2-byte floating-point number | 9.0xx |
| 4-byte value -2147483648...2147483647 | 13,001 |

The following table shows the possible reference functions (I = input value, R = reference value).

| Reference function | Function |
|----------------------|---|
| equal (I = R) | The comparator output is "ON" (true) if the input is equal to the reference value. Otherwise the output is "OFF" (false). |
| not equal (I ≠ R) | The comparator output is "ON" (true) if the input is unequal to the reference value. If the input value is equal to the reference value, the output is "OFF" (false). |
| greater than (I > R) | The comparator output is "ON" (true) if the input is greater than the reference value. If the input value is less than or equal to the reference value, the output will switch "OFF" (false). |

| Reference function | Function |
|---|---|
| greater than or equal ($I \geq R$) | The comparator output is "ON" (true) if the input is greater than the reference value or equal to the reference value. If the input value is smaller than the reference value, the output will switch "OFF" (false). |
| smaller than ($I < R$) | The comparator output is "ON" (true) if the input is less than the reference value. If the input value is greater than or equal the reference value, the output will switch "OFF" (false). |
| smaller than or equal ($I \leq R$) | The comparator output is "ON" (true) if the input is less than the reference value or equal to the reference value. If the input value is greater than the reference value, the output will switch "OFF" (false). |
| Range testing less than ($R1 < I < R2$) | There are two reference values. The comparator output is "ON" (true) if the input is greater than the first reference value or less than the second reference value. If the input value is less than the first reference value or equal the first reference value or greater than the second reference value or equal the second reference value, the output will switch "OFF" (false). |
| Range testing less than or equal to ($R1 \leq I \leq R2$) | There are two reference values. The comparator output is "ON" (true) if the input is greater than or equal the first reference value and smaller than or equal the second reference value. If the input value is smaller than the first reference value or greater than the second reference value, the output will switch "OFF" (false). |

The transmission behaviour of the comparator output can be configured.

11.5.1 Comparator parameters

The comparator works with an input whose data format can be parameterised, and with a 1-bit output to output the result of the comparison operation. The comparator compares the value received at the input with a configured reference value and evaluates whether the reference is correct (result = true) or not (result = false) according to the specified reference function.

The reference function and the reference value are configured in the ETS.

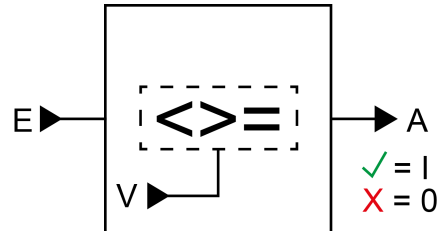

Figure 30: Comparator

The parameter "Data format" defines the size and format of input object according to the following table. The output object is preset to 1-bit (DPT 1.002) and outputs the result of the comparison operation (ON = true / OFF = false). The reference value that can be set in the ETS adapts to the input data format.

| Data format | KNX DPT |
|---------------------------------------|---------|
| 4-bit dimming | 3,007 |
| 1-byte operating mode switchover | 20,102 |
| 1-byte scene extension unit | 18,001 |
| 1-byte value 0...255 | 5,010 |
| 1-byte brightness value 0...100% | 5,001 |
| 2-byte value 0...65535 | 7,001 |
| 2-byte value -32768...32767 | 8,001 |
| 2-byte floating-point number | 9.0xx |
| 4-byte value -2147483648...2147483647 | 13,001 |

The following table shows the possible reference functions (I = input value, R = reference value).

| Reference function | Function |
|---|---|
| equal ($I = R$) | The comparator output is "ON" (true) if the input is equal to the reference value. Otherwise the output is "OFF" (false). |
| not equal ($I \neq R$) | The comparator output is "ON" (true) if the input is unequal to the reference value. If the input value is equal to the reference value, the output is "OFF" (false). |
| greater than ($I > R$) | The comparator output is "ON" (true) if the input is greater than the reference value. If the input value is less than or equal to the reference value, the output will switch "OFF" (false). |
| greater than or equal ($I \geq R$) | The comparator output is "ON" (true) if the input is greater than the reference value or equal to the reference value. If the input value is smaller than the reference value, the output will switch "OFF" (false). |
| smaller than ($I < R$) | The comparator output is "ON" (true) if the input is less than the reference value. If the input value is greater than or equal the reference value, the output will switch "OFF" (false). |
| smaller than or equal ($I \leq R$) | The comparator output is "ON" (true) if the input is less than the reference value or equal to the reference value. If the input value is greater than the reference value, the output will switch "OFF" (false). |
| Range testing less than ($R1 < I < R2$) | There are two reference values. The comparator output is "ON" (true) if the input is greater than the first reference value or less than the second reference value. If the input value is less than the first reference value or equal the first reference value or greater than the second reference value or equal the second reference value, the output will switch "OFF" (false). |
| Range testing less than or equal to ($R1 \leq I \leq R2$) | There are two reference values. The comparator output is "ON" (true) if the input is greater than or equal the first reference value and smaller than or equal the second reference value. If the input value is smaller than the first reference value or greater than the second reference value, the output will switch "OFF" (false). |

The transmission behaviour of the comparator output can be configured.

11.5.2 Object list for Comparator

| Object no. | Function | Name | Type | DPT | Flag |
|--|------------------|------------------|-------|-------|--------------------|
| 327, 328, 329, 330, 331, 332, 333, 334 | Comparator Input | Logic... - Input | 4-bit | 3,007 | C, (R), W, -, A |
| <p>4-bit object as input of a comparator.</p> <p>This object is only available if the type of logic function is configured to "Comparator" and the data format is configured to "4-bit dimming (DPT 3.007)".</p> | | | | | |

| Object no. | Function | Name | Type | DPT | Flag |
|---|------------------|------------------|--------|--------|--------------------|
| 343, 344, 345, 346, 347, 348, 349, 350 | Comparator Input | Logic... - Input | 1-byte | 20,102 | C, (R), W, -, A |
| <p>1-byte object as input of a comparator.</p> <p>This object is only available if the type of logic function is configured to "Comparator" and the data format is configured to "1-byte operating mode switchover (DPT 20.102)".</p> | | | | | |

| Object no. | Function | Name | Type | DPT | Flag |
|--|------------------|------------------|--------|--------|--------------------|
| 343, 344, 345, 346, 347, 348, 349, 350 | Comparator Input | Logic... - Input | 1-byte | 18,001 | C, (R), W, -, A |
| <p>1-byte object as input of a comparator.</p> <p>This object is only available if the type of logic function is configured to "Comparator" and the data format is configured to "1-byte scene extension unit (DPT 18.001)".</p> | | | | | |

| Object no. | Function | Name | Type | DPT | Flag |
|--|------------------|------------------|--------|-------|--------------------|
| 343, 344, 345, 346, 347, 348, 349, 350 | Comparator Input | Logic... - Input | 1-byte | 5,010 | C, (R), W, -, A |
| <p>1-byte object as input of a comparator.</p> <p>This object is only available if the type of logic function is configured to "Comparator" and the data format is configured to "1-byte value 0...255 (DPT 5.010)".</p> | | | | | |

| Object no. | Function | Name | Type | DPT | Flag |
|--|------------------|------------------|--------|-------|--------------------|
| 343, 344, 345, 346, 347, 348, 349, 350 | Comparator Input | Logic... - Input | 1-byte | 5,001 | C, (R), W, -, A |
| <p>1-byte object as input of a comparator.</p> <p>This object is only available if the type of logic function is configured to "Comparator" and the data format is configured to "1-byte brightness value 0...100% (DPT 5.001)".</p> | | | | | |

| Object no. | Function | Name | Type | DPT | Flag |
|--|------------------|------------------|--------|-------|--------------------|
| 359, 360, 361, 362, 363, 364, 365, 366 | Comparator Input | Logic... - Input | 2-byte | 7,001 | C, (R), W, -, A |
| <p>2-byte object as input of a comparator.</p> <p>This object is only available if the type of logic function is configured to "Comparator" and the data format is configured to "2-byte value 0...65535 (DPT 7.001)".</p> | | | | | |

| Object no. | Function | Name | Type | DPT | Flag |
|---|------------------|------------------|--------|-------|--------------------|
| 359, 360, 361, 362, 363, 364, 365, 366 | Comparator Input | Logic... - Input | 2-byte | 8,001 | C, (R), W, -, A |
| <p>2-byte object as input of a comparator.</p> <p>This object is only available if the type of logic function is configured to "Comparator" and the data format is configured to "2-byte value -32768...32767 (DPT 8.001)".</p> | | | | | |

| Object no. | Function | Name | Type | DPT | Flag |
|---|------------------|------------------|--------|-------|--------------------|
| 359, 360, 361, 362, 363, 364, 365, 366 | Comparator Input | Logic... - Input | 2-byte | 9,xxx | C, (R), W, -, A |
| <p>2-byte object as input of a comparator.</p> <p>This object is only available if the type of logic function is configured to "Comparator" and the data format is configured to "2-byte floating point value (DPT 9.0xx)".</p> | | | | | |

| Object no. | Function | Name | Type | DPT | Flag |
|--|------------------|------------------|--------|--------|--------------------|
| 375, 376, 377, 378, 379, 380, 381, 382 | Comparator Input | Logic... - Input | 4-byte | 13,001 | C, (R), W, -, A |
| <p>4-byte object as input of a comparator.</p> <p>This object is only available if the type of logic function is configured to "Comparator" and the data format is configured to "4-byte value -2,147,483,648...2,147,483,647 (DPT 13.001)".</p> | | | | | |

| Object no. | Function | Name | Type | DPT | Flag |
|--|-------------------|-------------------|-------|-------|--------------------|
| 383, 385, 387, 389, 391, 393, 395, 397 | Comparator Output | Logic... - Output | 1-bit | 1,002 | C, (R), -, T, A |
| <p>1-bit object as output of a comparator. The output object is preset to 1-bit (DPT 1.002) and outputs the result of the comparison operation (ON = true / OFF = false). This object is only available if the type of logic function is configured to "Comparator".</p> | | | | | |

11.6 Limit value switch

The limit value switch works with an input whose data format can be configured, and with a 1-bit output to output the result of the threshold evaluation. The limit value switch compares the value received at the input with two configurable hysteresis threshold values. Once the upper threshold value (H2) is reached or exceeded, the output can transmit a switching telegram (e. g. ON = true). If the value falls below the lower threshold value (H1), the output can transmit another switching telegram (e. g. OFF = false).

The switching telegrams can always be configured in the ETS when the threshold values are exceeded and undershot.

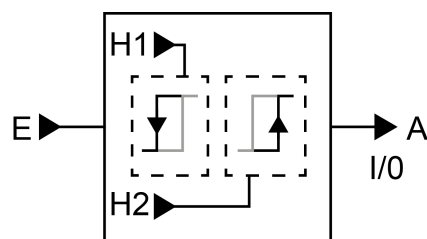

Figure 31: Limit value switch

The two threshold values define a hysteresis. The hysteresis prevents frequent switching backwards and forwards of the output if the input value constantly changes in small intervals. Only when the change in value at the input exceeds the hysteresis as a whole, does the output switch the status.

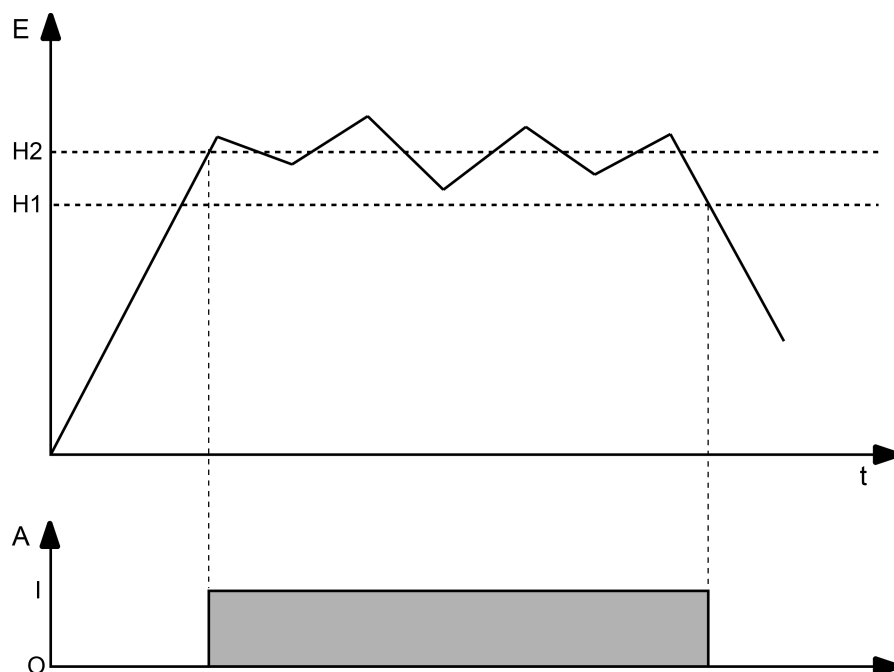

Figure 32: Example of a hysteresis evaluation by upper and lower threshold value

- i** The two threshold values can be freely configured in the ETS. Make sure that the upper threshold value is greater than the lower one!

- i** After the bus voltage returns or after an ETS programming operation, the output always transmits a telegram when the first value has been received at the input. The telegram depends on whether the value reaches or exceeds the upper threshold (H2) or not. If the value is less than the upper threshold, a telegram is transmitted in accordance with "Telegram upon not reaching the lower threshold". Otherwise the output transmits the "Telegram on exceeding the upper threshold value".

The parameter "Data format" defines the size and format of input object according to the following table. The output object is preset to 1-bit (DPT 1.002) and outputs the result of the threshold evaluation (ON = true / OFF = false). The threshold values that can be set in the ETS adapt to the input data format.

| Data format | KNX DPT |
|---------------------------------------|---------|
| 4-bit dimming | 3,007 |
| 1-byte operating mode switchover | 20,102 |
| 1-byte scene extension unit | 18,001 |
| 1-byte value 0...255 | 5,010 |
| 1-byte brightness value 0...100% | 5,001 |
| 2-byte value 0...65535 | 7,001 |
| 2-byte value -32768...32767 | 8,001 |
| 2-byte floating-point number | 9.0xx |
| 4-byte value -2147483648...2147483647 | 13,001 |

The transmission behaviour of the limit value switch can be configured.

11.6.1 Limit value switch parameters

The limit value switch works with an input whose data format can be configured, and with a 1-bit output to output the result of the threshold evaluation. The limit value switch compares the value received at the input with two configurable hysteresis threshold values. Once the upper threshold value (H2) is reached or exceeded, the output can transmit a switching telegram (e. g. ON = true). If the value falls below the lower threshold value (H1), the output can transmit another switching telegram (e. g. OFF = false).

The switching telegrams can always be configured in the ETS when the threshold values are exceeded and undershot.

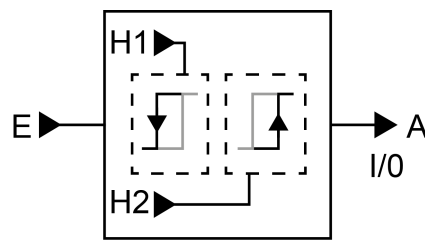

Figure 33: Limit value switch

The two threshold values define a hysteresis. The hysteresis prevents frequent switching backwards and forwards of the output if the input value constantly changes in small intervals. Only when the change in value at the input exceeds the hysteresis as a whole, does the output switch the status.

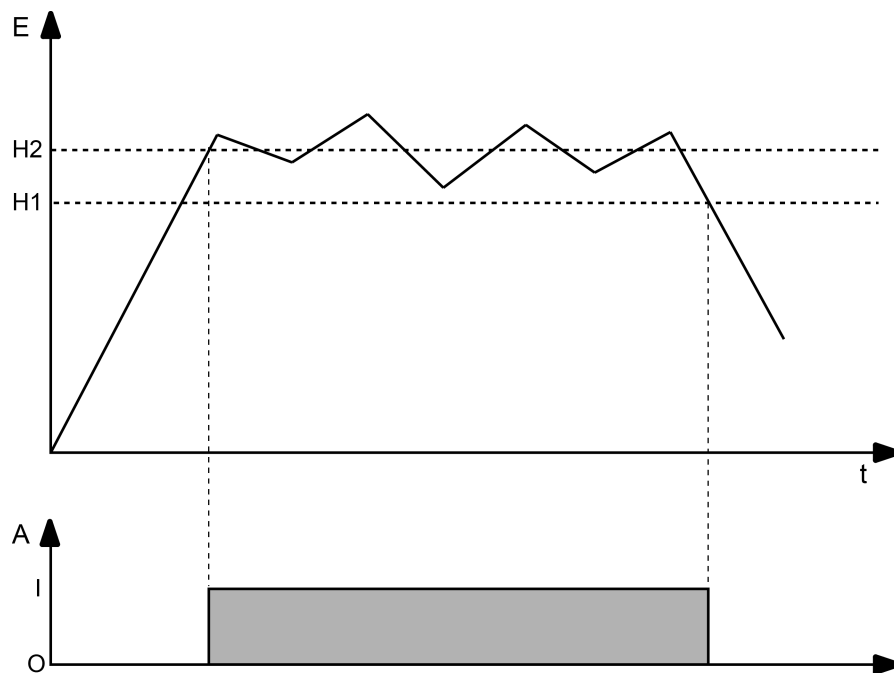

Figure 34: Example of a hysteresis evaluation by upper and lower threshold value

i The two threshold values can be freely configured in the ETS. Make sure that the upper threshold value is greater than the lower one!

- i** After the bus voltage returns or after an ETS programming operation, the output always transmits a telegram when the first value has been received at the input. The telegram depends on whether the value reaches or exceeds the upper threshold (H2) or not. If the value is less than the upper threshold, a telegram is transmitted in accordance with "Telegram upon not reaching the lower threshold". Otherwise the output transmits the "Telegram on exceeding the upper threshold value".

The parameter "Data format" defines the size and format of input object according to the following table. The output object is preset to 1-bit (DPT 1.002) and outputs the result of the threshold evaluation (ON = true / OFF = false). The threshold values that can be set in the ETS adapt to the input data format.

| Data format | KNX DPT |
|---------------------------------------|---------|
| 4-bit dimming | 3,007 |
| 1-byte operating mode switchover | 20,102 |
| 1-byte scene extension unit | 18,001 |
| 1-byte value 0...255 | 5,010 |
| 1-byte brightness value 0...100% | 5,001 |
| 2-byte value 0...65535 | 7,001 |
| 2-byte value -32768...32767 | 8,001 |
| 2-byte floating-point number | 9.0xx |
| 4-byte value -2147483648...2147483647 | 13,001 |

The transmission behaviour of the limit value switch can be configured.

11.6.2 Object list for limit value switch

| Object no. | Function | Name | Type | DPT | Flag |
|--|-----------------------------|------------------|-------|-------|--------------------|
| 327, 328, 329, 330, 331, 332, 333, 334 | Limit value switch Input | Logic... - Input | 4-bit | 3,007 | C, (R), W, -, A |
| <p>4-bit object as input of a limit value switch.</p> <p>This object is only available if the type of logic function is configured to "Limit value switch" and the data format is configured to "4-bit dimming (DPT 3.007)".</p> | | | | | |

| Object no. | Function | Name | Type | DPT | Flag |
|---|-----------------------------|------------------|--------|--------|--------------------|
| 343, 344, 345, 346, 347, 348, 349, 350 | Limit value switch Input | Logic... - Input | 1-byte | 20,102 | C, (R), W, -, A |
| <p>1-byte object as input of a limit value switch.</p> <p>This object is only available if the type of logic function is configured to "Limit value switch" and the data format is configured to "1-byte operating mode switchover (DPT 20.102)".</p> | | | | | |

| Object no. | Function | Name | Type | DPT | Flag |
|--|-----------------------------|------------------|--------|--------|--------------------|
| 343, 344, 345, 346, 347, 348, 349, 350 | Limit value switch Input | Logic... - Input | 1-byte | 18,001 | C, (R), W, -, A |
| <p>1-byte object as input of a limit value switch.</p> <p>This object is only available if the type of logic function is configured to "Limit value switch" and the data format is configured to "1-byte scene extension unit (DPT 18.001)".</p> | | | | | |

| Object no. | Function | Name | Type | DPT | Flag |
|--|-----------------------------|------------------|--------|-------|--------------------|
| 343, 344, 345, 346, 347, 348, 349, 350 | Limit value switch Input | Logic... - Input | 1-byte | 5,010 | C, (R), W, -, A |
| <p>1-byte object as input of a limit value switch.</p> <p>This object is only available if the type of logic function is configured to "Limit value switch" and the data format is configured to "1-byte value 0...255 (DPT 5.010)".</p> | | | | | |

| Object no. | Function | Name | Type | DPT | Flag |
|---|-----------------------------|------------------|--------|-------|--------------------|
| 343, 344, 345, 346, 347, 348, 349, 350 | Limit value switch Input | Logic... - Input | 1-byte | 5,001 | C, (R), W, -, A |

1-byte object as input of a limit value switch.

This object is only available if the type of logic function is configured to "Limit value switch" and the data format is configured to "1-byte brightness value 0...100% (DPT 5.001)".

| Object no. | Function | Name | Type | DPT | Flag |
|---|-----------------------------|------------------|--------|-------|--------------------|
| 359, 360, 361, 362, 363, 364, 365, 366 | Limit value switch Input | Logic... - Input | 2-byte | 7,001 | C, (R), W, -, A |

2-byte object as input of a limit value switch.

This object is only available if the type of logic function is configured to "Limit value switch" and the data format is configured to "2-byte value 0...65535 (DPT 7.001)".

| Object no. | Function | Name | Type | DPT | Flag |
|---|-----------------------------|------------------|--------|-------|--------------------|
| 359, 360, 361, 362, 363, 364, 365, 366 | Limit value switch Input | Logic... - Input | 2-byte | 8,001 | C, (R), W, -, A |

2-byte object as input of a limit value switch.

This object is only available if the type of logic function is configured to "Limit value switch" and the data format is configured to "2-byte value -32768...32767 (DPT 8.001)".

| Object no. | Function | Name | Type | DPT | Flag |
|---|-----------------------------|------------------|--------|-------|--------------------|
| 359, 360, 361, 362, 363, 364, 365, 366 | Limit value switch Input | Logic... - Input | 2-byte | 9,xxx | C, (R), W, -, A |

2-byte object as input of a limit value switch.

This object is only available if the type of logic function is configured to "Limit value switch" and the data format is configured to "2-byte floating point value (DPT 9.0xx)".

| Object no. | Function | Name | Type | DPT | Flag |
|---|-----------------------------|------------------|--------|--------|--------------------|
| 375, 376, 377, 378, 379, 380, 381, 382 | Limit value switch Input | Logic... - Input | 4-byte | 13,001 | C, (R), W, -, A |

4-byte object as input of a limit value switch.
 This object is only available if the type of logic function is configured to "Limit value switch" and the data format is configured to "4-byte value -2,147,483,648...2,147,483,647 (DPT 13.001)".

| Object no. | Function | Name | Type | DPT | Flag |
|---|------------------------------|-------------------|-------|-------|--------------------|
| 383, 385, 387, 389, 391, 393, 395, 397 | Limit value switch Output | Logic... - Output | 1-bit | 1,002 | C, (R), -, T, A |

1-bit object as output of a limit value switch. The output object is preset to 1-bit (DPT 1.002) and outputs the result of the threshold evaluation (ON = true / OFF = false).
 This object is only available if the type of logic function is configured to "Limit value switch".

12 As-delivered state

In the as-delivered state, the actuator is passive, i.e. no telegrams are transmitted to the KNX. All dimming channels are set to the universal dimming principle with automatic recognition of the load type. The outputs can, however, be activated by manual operation on the device, if the bus voltage is on. With manual control, no feedback telegrams are sent to the KNX.

The device can be programmed and put into operation via the ETS. The physical address is preset to 15.15.255.

Moreover the device has been configured at the factory with the following characteristics...

- Behaviour in case of bus voltage failure: no reaction
- Behaviour in case of bus voltage return: brightness before bus voltage failure
- Status indication: permanent

i The as-delivered state cannot be restored by unloading the application program with the aid of the ETS. When the application program is removed, all the outputs remain permanently switched off. The manual operation remains without function in this case.

Insta GmbH

Hohe Steinert 10

D-58509 Lüdenscheid

Telefon +49 (0) 2351 936-0

www.insta.de

info@insta.de